



Office of the City Manager

CONSENT CALENDAR  
January 21, 2020

To: Honorable Mayor and Members of the City Council  
 From: Dee Williams-Ridley, City Manager  
 Submitted by: Kelly Wallace, Interim Director, Health, Housing & Community Services  
 Subject: Approving a Partial Assignment and Third Amendment to the Disposition and Development Agreement, Ground Leases, and Certain Related Documents for 2012 Berkeley Way

RECOMMENDATION

Adopt first reading of an Ordinance approving a Partial Assignment and Third Amendment to the Disposition and Development Agreement for 2012 Berkeley Way, the three ground leases outlined in the Disposition and Development Agreement, and two Reciprocal Easement, Maintenance and Joint Use Agreements required for project operations.

FISCAL IMPACTS OF RECOMMENDATION

The attached partial assignment and amendment to the Disposition and Development Agreement (DDA, City contract #R10284C), ground leases and other documents do not change the previously approved financial terms of the project. The City will enter into three ground leases and receive a one-time payment of \$500 for each. The attached documents will enable the development of the proposed Berkeley Way project but do not commit additional City funds.

The City has separately committed (subject to satisfaction of certain conditions) \$27,467,548 in housing financing for the project. Almost \$4 million of that total was provided as a predevelopment loan; as of this writing in early December 2019, all but \$270,000 of that amount has been disbursed. The balance of funds are planned to be made available through three loans at the start of construction by April 2020. The majority of City financing is projected to come from Measure O bonds, which the Council will be asked to approve in the next few months.

CURRENT SITUATION AND ITS EFFECTS

In 2016, the City entered into a Disposition and Development Agreement with BRIDGE Housing Corporation that established the terms and conditions for their eventual lease of the City-owned parking lot at 2012 Berkeley Way. After the City selected the team of BRIDGE and the Berkeley Food and Housing Project (BFHP) as the site's developer, BRIDGE and BFHP proposed leasing (rather than purchasing) the site. The long term

lease will give the City a greater role in the use of the site in the future than would have been possible through a sale.

The site's development will include three separately financed projects: 89 units of affordable housing, 53 units of permanent supportive housing for homeless households, and BFHP's Hope Center, a facility providing 44 temporary housing (32 shelter and 12 transitional) beds along with congregate meal and social services space. BRIDGE has secured all of the financing for all three projects and construction will start in April 2020.

The attached ordinance approves (i) a Partial Assignment and Third Amendment to the DDA revising the timing of leases and confirming approval of certain project mechanics, which will make the DDA and the leases consistent and (ii) three ground leases, one for each of the three project components (affordable housing, permanent supportive housing, and homeless shelter/services (temporary housing)). Additionally, the Ordinance approves two Reciprocal Easement, Maintenance and Joint Use Agreements (REAs), which are the agreements that establish the terms of the relationships between the different projects for operations. One REA establishes responsibilities and relationships for the entire project (all three components); the second REA governs certain matters solely between the permanent supportive housing and shelter (temporary housing) parcels. The City's interest in these agreements is as the owner of the property.

These documents are necessary to allow the developer project team to take possession of the site and start construction by April 2020. Council's approval at tonight's meeting is an important milestone in the project's timeline.

The Berkeley Way project is a Strategic Plan Priority Project, advancing our goal to create affordable housing and housing support service for our most vulnerable community members.

#### BACKGROUND

In 2014, the City selected BRIDGE Housing Corporation and the Berkeley Food and Housing Project to redevelop the City-owned parking lot at 2012 Berkeley Way into affordable housing, permanent supportive housing, and homeless shelter (temporary housing) and services. In 2016 with Ordinances 7,479-N.S. and 7,480-N.S., the City approved a Disposition and Development Agreement (DDA) which established the terms and conditions for the eventual leasing of the site for the purpose of the project. The DDA has subsequently been amended several times as the project plan has been further developed. Under the current design, the project will be a single building containing all three project components. The developer project team has secured commitments for all needed financing for the project and must start construction by April 2020 to satisfy the terms of the commitment of Low Income Housing Tax Credits, which will provide \$37M in project funding.

BRIDGE and BFHP have also created separate limited partnerships that they control and which are necessary for the financing of the separate project components. BRIDGE Berkeley Way LP, a BRIDGE-controlled limited partnership, will own the 89 units of affordable housing. The temporary housing and permanent supportive housing will be developed by BFHP Hope Center LP, controlled by both BRIDGE and BFHP with majority control by BRIDGE. At the end of construction, ownership of the temporary housing will be transferred to BFHP LLC, a limited liability corporation created by BFHP to own the property.

If the Council approves the attached ordinance, prior to construction, the City will enter into three separate leases and loan agreements, one for each of the projects, the REAs, and an amended agreement with BRIDGE regarding the City's responsibility and liability for completing the \$3.8M in state-funded Affordable Housing and Sustainable Communities (AHSC) transportation infrastructure projects that Council authorized on January 22, 2019 with Resolution 68,730-N.S.

Each project will be financed separately using a package of different sources:

- BRIDGE's affordable apartments: City loan, tax-exempt and taxable loans from Prudential, Alameda County A1 funds, state AHSC funds, the Federal Home Loan Bank's Affordable Housing Program, the Low Income Housing Tax Credit (LIHTC) program, and project-based Housing Choice Vouchers from the Berkeley Housing Authority.
- Hope Center permanent supportive housing: City and County loans, at least three state housing programs, LIHTC, and project-based Housing Choice Vouchers from the Berkeley Housing Authority.
- Hope Center temporary housing and services space: City and County loans and BFHP capital campaign proceeds.

#### ENVIRONMENTAL SUSTAINABILITY

Approval of the DDA amendment, ground leases, and REAs will enable the developer project team to develop a portion of this surface parking lot into affordable infill housing in close proximity to BART, which is typically considered a more sustainable form of development.

#### RATIONALE FOR RECOMMENDATION

Approval of these documents is consistent with the Council's goal of completing this project and the City's existing contract for the project to enter into leases if the project satisfies certain conditions.

#### ALTERNATIVE ACTIONS CONSIDERED

Staff did not identify another alternative consistent with seeing the proposed project to fruition.

CONTACT PERSON

Amy Davidson, Senior Community Development Project Coordinator, HHCS, (510) 981-5406

Attachments:

1: Ordinance

- Exhibit A: Partial Assignment and Third Amendment to Disposition and Development Agreement
- Exhibit B: Ground Lease 2012 Berkeley Way: Berkeley Way BRIDGE Affordable Apartments
- Exhibit C: Ground Lease 2012 Berkeley Way: Berkeley Way Permanent Supportive Housing Apartments
- Exhibit D: Ground Lease 2012 Berkeley Way: Berkeley Way Hope Center Temporary Housing
- Exhibit E: Declaration and Agreement Regarding Covenants, Conditions and Restrictions Providing for Reciprocal Easements, Joint Use and Maintenance for Berkeley Way
- Exhibit F: Declaration and Agreement Regarding Covenants, Conditions and Restrictions Providing for Reciprocal Easements, Joint Use and Maintenance for the BFHP Hope Center
- Exhibit G: Draft Parcel Map



ORDINANCE NO. -N.S.

APPROVING A PARTIAL ASSIGNMENT AND THIRD AMENDMENT TO THE DISPOSITION AND DEVELOPMENT AGREEMENT, THREE GROUND LEASES, AND CERTAIN RELATED DOCUMENTS FOR 2012 BERKELEY WAY

BE IT ORDAINED by the Council of the City of Berkeley as follows:

Section 1. FINDINGS

In 2014, the City selected BRIDGE Housing Corporation (BRIDGE) and the Berkeley Food and Housing Project (BFHP) to redevelop the City-owned parking lot at 2012 Berkeley Way into a single building with three separate components: affordable housing, permanent supportive housing, and homeless shelter (temporary housing) and services. In 2016 with Ordinances 7,479-N.S. and 7,480-N.S., the City approved a Disposition and Development Agreement (DDA) with BRIDGE as the named “Developer,” which established the initial terms and conditions for the eventual leasing of the site for the purpose of the project. The site will be subdivided into three separate legal parcels, one for each of the three project components, with each parcel leased to a separate tenant under a separate 75-year ground lease.

Under prior Council approved amendments and a partial assignment to the DDA, the deadlines for leasing the site and completing project construction were extended, some specific project development procedures were modified, and Developer BRIDGE formally assigned its interest in the permanent supportive housing and homeless shelter (temporary housing) components (together referred to as “The Hope Center”) to BFHP Hope Center LP, an affiliate of BRIDGE and BFHP (BFHP LP).

Consistent with the DDA and prior Council approvals, the three current project components are expected to include the following:

- Affordable Housing: Approximately 89 units of affordable housing (including one manager’s unit).
- Permanent Supportive Housing: Approximately 53 units of supportive housing.
- Homeless Shelter (Temporary Housing): Temporary housing (approximately 44 beds), a services center and administrative office space.

The City and BRIDGE have been processing a site subdivision map, which, once finalized and recorded, will be the basis of the legal descriptions of the three project ground lease parcels and will be attached to the three ground leases. The map is expected to be finalized by approximately the end of 2019.

In order to effectuate the development of the site, the City now wishes to take certain actions: to further amend the DDA and approve BRIDGE’s assignment of the affordable housing project component to Bridge Berkeley Way LP, an affiliate of BRIDGE (Bridge LP), approve one ground lease for each project component as anticipated in the DDA, and approve two Reciprocal Easement, Maintenance and Joint Use Agreements (REAs)

to govern operational specifics among the separate component tenants, also as anticipated by the DDA.

**Section 2. AUTHORIZATION FOR THE CITY MANAGER TO ENTER INTO A PARTIAL ASSIGNMENT AND THIRD AMENDMENT TO THE DISPOSITION AND DEVELOPMENT AGREEMENT**

The City Manager is hereby authorized to enter into a Partial Assignment and Third Amendment to Disposition and Development Agreement (Third Amendment) which will allow for the BRIDGE Housing Corporation to assign its rights regarding the affordable housing component of the project to Bridge LP and to clarify certain details of the property transfer, including that both the permanent supportive housing and shelter (temporary housing) components will initially be ground leased to BFHP Hope Center LP, an affiliate of BRIDGE and BFHP (BFHP LP), and following project construction the shelter (temporary housing) component ground lease will be assigned to BFHP Hope Center LLC, an affiliate of BFHP (BFHP LLC). Such Third Amendment shall be on substantially the same terms as Exhibit A.

**Section 3. AUTHORIZATION FOR THE CITY MANAGER TO ENTER INTO ONE GROUND LEASE WITH BRIDGE BERKELEY WAY LP AND TWO GROUND LEASES WITH BFHP HOPE CENTER LP**

The City Manager is hereby authorized to enter into one ground lease with Bridge LP for the affordable housing parcel, one ground lease with BFHP LP for the permanent supportive housing parcel, and one ground lease with BFHP LP for the shelter (temporary housing) and services parcel. The City Manager is hereby authorized to enter into the ground leases including draft premises legal descriptions based on the tentative subdivision map if the subdivision has not yet been completed, and is authorized to include final premises legal descriptions and replace the draft subdivision map (included as Exhibit G) with the final subdivision map when available. Such ground leases shall be on substantially the same terms as Exhibits B, C, and D.

**Section 4. AUTHORIZATION FOR THE CITY MANAGER TO ENTER INTO TWO RECIPROCAL EASEMENT, MAINTENANCE AND JOINT USE AGREEMENTS FOR 2012 BERKELEY WAY**

The City Manager is hereby authorized to enter, as property owner, into two Reciprocal Easement, Maintenance and Joint Use Agreements (REAs) establishing the responsibilities and relationships between the tenants under the ground leases. Such agreements shall be on substantially the same terms as Exhibits E and F.

**Section 5.** Copies of this Ordinance shall be posted for two days prior to adoption in the display case located near the walkway in front of the Maudelle Shirek Building, 2134 Martin Luther King Jr. Way. Within 15 days of adoption, copies of this Ordinance shall be filed at each branch of the Berkeley Public Library and the title shall be published in a newspaper of general circulation.

Exhibits

A: Partial Assignment and Third Amendment to Disposition and Development Agreement

B: Ground Lease 2012 Berkeley Way: Berkeley Way BRIDGE Affordable Apartments

C: Ground Lease 2012 Berkeley Way: Berkeley Way Permanent Supportive Housing Apartments

D: Ground Lease 2012 Berkeley Way: Berkeley Way Hope Center Temporary Housing

E. Declaration and Agreement Regarding Covenants, Conditions and Restrictions Providing for Reciprocal Easements, Joint Use and Maintenance for Berkeley Way

F: Declaration and Agreement Regarding Covenants, Conditions and Restrictions Providing for Reciprocal Easements, Joint Use and Maintenance for the BFHP Hope Center

G: Draft Parcel Map

RECORDING REQUESTED BY  
AND WHEN RECORDED MAIL TO:

12-2-2019

City of Berkeley  
Housing Department  
2180 Milvia Street, 2<sup>nd</sup> Floor  
Berkeley, CA 94704  
Attn: Housing & Community Services  
Manager

NO FEE FOR RECORDING PURSUANT TO GOVERNMENT CODE SECTION 27383  
& 27388.1

---

(space above for Recorder's use)

PARTIAL ASSIGNMENT AND THIRD AMENDMENT TO DISPOSITION AND  
DEVELOPMENT AGREEMENT  
(Berkeley Way)

THIS PARTIAL ASSIGNMENT AND THIRD AMENDMENT (the "**Third Amendment**") to the Disposition and Development Agreement is entered into as of the \_\_\_\_\_ day of \_\_\_\_\_ 2020 (the "**Effective Date**"), by and between BRIDGE HOUSING CORPORATION, a California nonprofit public benefit corporation ("**BRIDGE**"), BFHP HOPE CENTER LP, a California Limited Partnership ("**BFHP LP**"), Bridge Berkeley Way LP, a California Limited Partnership ("**BRIDGE LP**") and the CITY OF BERKELEY, a charter city (the "**City**", together with BRIDGE, BFHP LP and BRIDGE LP, the "**Parties**") with reference to the following facts:

RECITALS

- A. BRIDGE and the City entered into a Disposition and Development Agreement dated as of June 8, 2016 (the "**Original Agreement**"), as amended by that certain First Amendment to Disposition and Development Agreement dated August 27, 2018 (the "**First Amendment**") and that certain Second Amendment to Disposition and Development Agreement dated February 1, 2019 (the "**Second Amendment**"), and as partially assigned to BFHP LP pursuant to the terms of that certain Partial Assignment and Assumption Agreement dated December 17, 2018 (the "**Assignment**"; and collectively with the Original Agreement, the First Amendment and the Second Amendment, the "**DDA**"). Capitalized terms used, but not defined in this Third Amendment shall have the meaning set forth in the DDA.
- B. Pursuant to the DDA, the City agreed to lease the Property for the construction and operation of the Development. Specifically, the Development includes: the BHC Improvements, which are approximately 89 units of affordable housing to be constructed and owned by an affiliate of BRIDGE Housing Corporation (the "**BRIDGE Development**"); the BFHP Permanent Improvements, which consist of

approximately 53 units of supportive housing; and, the BFHP Temporary Improvements, which consist of temporary housing (approximately 44 beds), a services center and administrative office space. The BFHP Permanent Improvements and the BFHP Temporary Improvements are commonly referred to, collectively, as the "**BFHP Hope Center**".

- C. BRIDGE previously assigned its rights pertaining to the BFHP Hope Center to BFHP LP. BRIDGE now desires to assign its remaining rights and obligations under the DDA, specifically those pertaining to the BRIDGE Development, to BRIDGE LP and BRIDGE LP desires to assume such rights and obligations.
- D. The Parties also desire to clarify certain transaction details pertaining to the Development.

NOW, THEREFORE, in consideration of the foregoing, of the mutual promises of the Parties hereto and for other good and valuable consideration the receipt and sufficiency of which are hereby acknowledged, the parties mutually agree as follows:

1. Development Schedule. Section 2.3 (a) of the DDA is deleted and replaced in its entirety with the following, to reflect the current Development Schedule: "The Development Schedule is attached to the Partial Assignment and Third Amendment to Disposition and Development Agreement dated \_\_\_\_\_, 2020, as Exhibit B."

2. Development Services Agreement. DDA Section 2.4 is hereby amended and restated to read in full as follows:

**Section 2.4 Joint Development Agreement and Developer Agreements.** On or before the date set forth in the Development Schedule (i) BHC LP shall enter into a Joint Development Agreement and Cost Allocation Agreement ("JDA") which will set forth the manner in which BHC LP and BFHP LP will develop and construct the Development in a coordinated and efficient manner consistent with the requirements of the DDA and (ii) BHC LP and BFHP LP will engage BRIDGE to provide predevelopment and preconstruction services for the Development pursuant to a Predevelopment Services Agreement among BHC LP, BFHP LP and BRIDGE, which will be replaced at Close of Escrow by two Development Services Agreements (one for the BHC Improvements and one for the BFHP Hope Center) to provide construction phase services for the Development (collectively, the ("Developer Agreements")). The Developer Agreements and the JDA are subject to the prior approval of the City. References in the Agreement to "Master LLC Agreement" or "DSA" are hereby replaced with JDA.

3. Final Subdivision Map. DDA Section 2.18 is hereby amended and restated to read in full as follows:

**Section 2.18 Final Subdivision Map.** On or before the Close of Escrow, the Developer shall apply for final approval by the City of the Final Subdivision

Map, and all applicable time periods required by law to render such approvals free from legal challenge shall have expired without challenge. If the foregoing cannot be completed by Close of Escrow, the City may convey the applicable portions of the Property to the Permitted Lessee by metes and bounds descriptions. If the Developer obtains a Final Subdivision Map for the Property, the City will cooperate in connection with the recordation of such Map.

4. Hazardous Materials. DDA Section 6.2 is hereby amended and restated to read in full as follows:

**Section 6.2 Hazardous Materials.**

(a) Certain Covenants and Agreements. The Developer hereby covenants and agrees that:

(1) The Developer shall not knowingly permit the Development or any portion thereof to be a site for the use, generation, treatment, manufacture, storage, disposal or transportation of Hazardous Materials or otherwise knowingly permit the presence of Hazardous Materials in, on or under the Development.

(2) The Developer shall keep and maintain the Development and each portion thereof in compliance with, and shall not cause or permit the Development or any portion thereof to be in violation of, any Hazardous Materials Laws.

(3) Upon receiving actual knowledge of the same the Developer shall immediately advise the City in writing of: (i) any and all enforcement, cleanup, removal or other governmental or regulatory actions instituted, completed or threatened against the Developer or the Development pursuant to any applicable Hazardous Materials Laws; (ii) any and all claims made or threatened by any third party against the Developer or the Development relating to damage, contribution, cost recovery, compensation, loss or injury resulting from any Hazardous Materials (the matters set forth in the foregoing clause (i) and this clause (ii) are hereinafter referred to as "**Hazardous Materials Claims**"); (iii) the presence of any Hazardous Materials in, on or under the Development; or (iv) the Developer's discovery of any occurrence or condition on any real property adjoining or in the vicinity of the Development classified as "borderzone property" under the provisions of California Health and Safety Code, Sections 25220 et seq., or any regulation adopted in accordance therewith, or to be otherwise subject to any restrictions on the ownership, occupancy, transferability or use of the Development under any Hazardous Materials Laws. The City shall have the right to join and participate in, as a party if it so elects, any legal proceedings or actions initiated in connection with any Hazardous Materials Claims, and to have its reasonable attorney's fees in connection therewith paid by Developer.

(4) Without the City's prior written consent, which shall not be unreasonably withheld, and which the City shall promptly grant or deny, the Developer shall not take any remedial action in response to the presence of any Hazardous Materials on, under, or about the Development (other than in emergency situations or as required by governmental agencies having jurisdiction in which case the City agrees to provide its consent), nor enter into any settlement agreement, consent decree, or other compromise in respect to any Hazardous Materials Claims.

(b) Indemnity. Without limiting the generality of the indemnification set forth in Section 9.7 below, the Developer hereby agrees to indemnify, protect, hold harmless and defend (by counsel reasonably satisfactory to the City) the City, its council members, officers, and employees from and against any and all claims, losses, damages, liabilities, fines, penalties, charges, administrative and judicial proceedings and orders, judgments, remedial action requirements, enforcement actions of any kind, and all costs and expenses incurred in connection therewith (including, but not limited to, attorney's fees and expenses), arising directly or indirectly, in whole or in part, out of:

(1) The failure of the Developer, or any other person or entity to comply with any Hazardous Materials Law relating in any way whatsoever to the handling, treatment, presence, removal, storage, decontamination, cleanup, transportation or disposal of Hazardous Materials into, on, under or from the Development; or

(2) The presence in, on or under the Development of any Hazardous Materials or any releases or discharges of any Hazardous Materials into, on, under or from the Development; or

(3) Any activity carried on or undertaken on or off the Development, subsequent to the lease of the Property as provided in this Agreement, and whether by the Developer or any successor in title or any employees, agents, contractors or subcontractors of the Developer or any successor in title, or any third persons at any time occupying or present on the Development, in connection with the handling, treatment, removal, storage, decontamination, cleanup, transport or disposal of any Hazardous Materials at any time located or present on or under the Development.

The foregoing indemnity shall further apply to any residual contamination on or under the Development, or affecting any natural resources, and to any contamination of any property or natural resources arising in connection with the generation, use, handling, treatment, storage, transport or disposal of any such Hazardous Materials, and irrespective of whether any of such activities were or will be undertaken in accordance with Hazardous Materials Laws. The provisions of this subsection shall survive expiration of the Term or other termination of this Agreement, and shall remain in full force and effect.

(c) No Limitation. The Developer hereby acknowledges and agrees that the Developer's duties, obligations and liabilities under this Agreement, including, without limitation, under subsection (b) above, are in no way limited or otherwise affected by any information the City may have concerning the Development and/or the presence within the Development of any Hazardous Materials, whether the City obtained such information from the Developer or from its own investigations.

5. REA or Reciprocal Easement Agreement. As used in the DDA, the REA will include the REA governing operations of the Development (the "REA 1") and the REA governing operations of the Hope Center Property (the "REA 2"); provided that obligations under the DDA pertaining to the REA 2 will only be applicable to the BFHP Hope Center and the Hope Center Property.

6. Assignment. BRIDGE hereby assigns and delegates to BRIDGE LP, and BRIDGE LP hereby accepts from BRIDGE, BRIDGE's remaining rights and obligations under the DDA pertaining to the BRIDGE Development. BRIDGE LP hereby accepts the above assignment and hereby assumes, agrees, and undertakes to perform all of the obligations, liabilities, covenants, and agreements of BRIDGE pursuant to the DDA as such relate to the BRIDGE Development. As contemplated in Section 2.5 of the DDA, BRIDGE is hereby released from any and all obligations under the DDA, as amended by this Third Amendment, arising after the date of this Third Amendment. Nothing in this Section 4 limits or modifies Section 2.10 of the DDA pertaining to the guaranties of completion of the development of the Property in accordance with the DDA or BRIDGE's obligations under the Developer Agreements.

7. Agreement on Leases. Notwithstanding anything to the contrary in the DDA, including Section 2.8 of the DDA, the City, BFHP LP and BRIDGE LP seek to clarify that the term "Leases" at closing means: (1) one ground lease between BRIDGE LP and the City for the BHC Parcel; (2) one ground lease between BFHP LP and the City for the BFHP Permanent Parcel; and (3) one ground lease between BFHP LP and the City for the BFHP Temporary Parcel. References in the DDA to the Lease for the Hope Center Property mean the leases described in (2) and (3) above. Following completion of construction of the Temporary Improvements, the BFHP Temporary Parcel Lease will be assigned to the BFHP Entity, and the BFHP Temporary Improvements will be transferred to the BFHP Entity, subject to the consent of the Hope Center lenders and investors.

8. Termination of DDA. Excepting those provisions which will be specified to survive and which will be identified in an Exhibit in the Leases, the DDA will terminate in its entirety at Close of Escrow.

9. Further Assurances. The Parties agree to take such further actions as may be necessary or advisable to effectuate, confirm or document the amendment contemplated hereby, which is consistent with this Third Amendment and not otherwise consistent with the DDA.



10. Successors and Assignor. This Third Amendment shall be binding upon and shall inure to the benefit of each party hereto and its successors and assignors.

11. Effective Date. This Third Amendment shall be effective as of the Effective Date.

12. California Law. This Third Amendment shall be governed by and interpreted in accordance with the laws of the State of California.

13. Counterparts. This Third Amendment may be signed in counterparts, each of which shall constitute one and the same instrument.

SIGNATURES FOLLOW ON NEXT PAGE

IN WITNESS WHEREOF, the Parties have executed this Third Amendment as of the Effective Date.

BRIDGE LP:

BRIDGE Berkeley Way LP,  
a California limited partnership

By: BRIDGE Berkeley Way LLC,  
a California limited liability company,  
its general partner

By: BRIDGE Housing Corporation,  
a California nonprofit public benefit  
corporation,  
its co- member

By: \_\_\_\_\_  
Smitha Seshadri, Senior Vice  
President

BRIDGE:

BRIDGE HOUSING CORPORATION,  
a California nonprofit public benefit corporation

By: \_\_\_\_\_  
Smitha Seshadri,  
Senior Vice President

NOTE: SIGNATURE MUST BE NOTARIZED

[SIGNATURE PAGES CONTINUE]

BFHP LP:

BFHP Hope Center LP,  
a California limited partnership

By: Hope Center Housing LLC,  
a California limited liability company,  
its general partner

By: BRIDGE Housing Corporation,  
a California nonprofit public benefit  
corporation,  
its co- member

By: \_\_\_\_\_  
Smitha Seshadri, Senior Vice President

By: Berkeley Food and Housing Project,  
a California nonprofit religious corporation,  
its co- member

By: \_\_\_\_\_  
Executive Director

NOTE: SIGNATURE MUST BE NOTARIZED

[SIGNATURE PAGES CONTINUE]

CITY:

CITY OF BERKELEY, a charter city

By: \_\_\_\_\_

Name: B.D. Williams

Its: City Manager

APPROVED AS TO FORM

\_\_\_\_\_  
City Attorney

NOTE: SIGNATURE MUST BE NOTARIZED



A notary public or other officer completing this certificate verifies only the identity of the individual who signed the document to which this certificate is attached, and not the truthfulness, accuracy, or validity of

STATE OF CALIFORNIA )  
 )  
COUNTY OF \_\_\_\_\_ )

On \_\_\_\_\_, before me, \_\_\_\_\_, Notary Public, personally appeared \_\_\_\_\_, who proved to me on the basis of satisfactory evidence to be the person(s) whose name(s) is/are subscribed to the within instrument and acknowledged to me that he/she/they executed the same in his/her/their authorized capacity(ies), and that by his/her/their signature(s) on the instrument the person(s), or the entity upon behalf of which the person(s) acted, executed the instrument.

I certify UNDER PENALTY OF PERJURY under the laws of the State of California that the foregoing paragraph is true and correct.

WITNESS my hand and official seal.

\_\_\_\_\_  
Name: \_\_\_\_\_  
Notary Public



## EXHIBIT B

**Preliminary Development Schedule**  
**(Effective as of \_\_\_\_\_, 2020)**

This Development Schedule summarizes the schedule for various activities under the Disposition and Development Agreement (the “**Agreement**” or the “**DDA**”) to which this exhibit is attached. The description of items in this Development Schedule is meant to be descriptive only, and shall not be deemed to modify in any way the provisions of the DDA to which such items relate. Section references herein to the DDA are intended merely as an aid in relating this Development Schedule to other provisions of the DDA and shall not be deemed to have any substantive effect.

Whenever this Development Schedule requires the submission of plans or other documents at a specific time, such plans or other documents, as submitted, shall be complete and adequate for review by the City or other applicable governmental entity within the time set forth herein. Prior to the time set forth for each particular submission, the Developer shall consult with City staff informally as necessary concerning such submission in order to assure that such submission will be complete and in a proper form within the time for submission set forth herein.

<u>Action</u>	<u>Date</u>	<u>Date Completed</u>
1 <u>Developer Deposit.</u> The Developer shall deposit the Developer Deposit in the amount of \$10,000. [DDA § 2.2]	No later than three business days after the Effective Date.	June 13, 2016
2 <u>Approval of Title Matters.</u>	October 31, 2018	October 31, 2018
3 <u>Approval of JDA and Developer Agreements.</u> [DDA § 2.4]	BHC LP and BFHP LP will enter into the construction-phase Developer Agreements with Developer no later than the Close of Escrow.	BHC LP and BFHP LP entered into the JDA, and BHC LP, BFHP LP and Developer entered into the preconstruction/ predevelopment Developer Agreement, before executing the Third Amendment to DDA.



<u>Action</u>	<u>Date</u>	<u>Date Completed</u>
<p>4 <u>Developer Assignment to Permitted Lessees.</u> Developer shall create and assign all of its rights and obligations (except as otherwise provided in the Agreement) to the Permitted Lessees. [DDA §2.5]</p>	<p>Assignment to BHC LP no later than Close of Escrow.</p>	<p>Assignment to BFHP LP completed on December 17, 2018</p>
<p>5 <u>Approval of Leases.</u> The City and the Developer to approve the provisions of the Leases, each in its sole discretion. [DDA § 2.8]</p>	<p>No later than the Close of Escrow.</p>	
<p>6 <u>Approval of REA.</u> The City and the Developer to approve the provisions of the Reciprocal Easement Agreement, each in its sole discretion. [DDA § 2.9]</p>	<p>No later than the Close of Escrow.</p>	
<p>7 <u>Approval of Completion Guaranty Agreement.</u> The City and the Developer to approve the provisions of the Completion Guaranty Agreement, each in its sole discretion. [DDA § 2.10]</p>	<p>No later than the Close of Escrow.</p>	
<p>8 <u>Developer Submission of Preliminary Scope of Development and Preliminary Concept Drawings.</u> The Developer is to submit of Preliminary Scope of Development and Preliminary Concept Drawings to the City. [DDA § 3.1(a)]</p>		<p>February 26, 2016</p>

<u>Action</u>	<u>Date</u>	<u>Date Completed</u>
9 <u>Approval of Final Scope of Development and Final Concept Design Drawings.</u> The City and the Developer to approve the Final Scope of Development and Final Concept Design Drawings, each in its sole discretion. [DDA § 3.1(b)]		September 13, 2018
10 <u>Condition of Property.</u> Developer shall approve or disapprove of the condition of the Property. [DDA § 2.6]	October 31, 2018	October 31, 2018
11 <u>CEQA Compliance.</u> Preparation of Appropriate CEQA Document. [DDA § 2.11]		December 21, 2018 (CEQA has been satisfied with SB 35 approval)
12 <u>City and Other Governmental Approvals.</u> The Developer shall apply for and obtain the City Approvals and all governmental approvals necessary for the development and operation of the Development. [DDA §2.11]		December 21, 2018 (CEQA has been satisfied with SB 35 approval)
13 <u>Schematic Design Drawings.</u> The Developer shall submit the Schematic Design Drawings to the City. [DDA § 3.4(a)].		February 20, 2017
14 <u>Design Development Drawings.</u> The Developer shall submit the Design Development Drawings to the City. [DDA § 3.4(b)]		August 30, 2017

<u>Action</u>	<u>Date</u>	<u>Date Completed</u>
15 <u>Temporary Right of Entry.</u> The City shall grant the Developer the Temporary Right of Entry to enter the Property. [DDA § 9.19]	City grants the Temporary Right of Entry as of the Effective Date.	
16 <u>City Approval of Design Development Drawings.</u> The City shall approve or disapprove the Design Development Drawings. [DDA § 3.5]		December 21, 2018 (SB-35 approval date)
17 <u>Financing Proposal.</u> The Developer shall submit the initial Financing Proposal for the BHC Improvements, BFHP Permanent Improvements, and BFHP Temporary Improvements for the City's review and approval. [DDA § 2.12(a)]		August 23, 2017
18 <u>City Financing Application.</u> If Developer will seek City Financing, the Developer shall submit its application for City Financing for the City's review and approval. [DDA § 2.12(d)]		August 23, 2017

<u>Action</u>	<u>Date</u>	<u>Date Completed</u>
19 <u>City Approval of Financing Plans</u> . The City shall review and either approve or disapprove of the financing plans for the BHC Improvements, BFHP Permanent Improvements, and BFHP Temporary Improvements. [DDA § 2.12(c)]	Within <b>[TBD]</b> days following receipt of each initial Financing Plan. Each Financing Plan must be approved by the City no later than <b>[TBD]</b> days following the date of the initial Financing Plan. All Financing Plans must be approved no later than <b>June 30, 2021</b> ; provided, however the City has no obligation to approve any Financing Plan if such Financing Plan does not meet the requirements set forth in Section 2.12.	
20 <u>Final Construction Drawings</u> . The Developer shall submit the Final Construction Drawings to the City. [DDA § 3.4(c) and § 2.17]	No later than <b>April 3, 2020</b> .	
21 <u>City Approval of Final Construction Drawings</u> . The City shall either approve or disapprove the Final Construction Drawings. [DDA § 3.5(b)]	No later than <b>[10]</b> days after City's receipt, provided such drawings are consistent with Article III.	
22 <u>Building Permits</u> . The Developer shall obtain the Building Permits for construction of the Development. [DDA § 2.16]	No later than Close of Escrow.	

<u>Action</u>	<u>Date</u>	<u>Date Completed</u>
23 <u>Construction Contracts</u> . The Developer shall submit for the City's approval the construction contracts for the construction of the Improvements. [DDA § 2.14]	No later than <b>10 business</b> days before the Pre-Lease Deadline or Close of Escrow, whichever is first.	
24 <u>Construction Bonds</u> . The Developer shall submit payment and performance bonds for the Improvements. [DDA § 2.15]	No later than Close of Escrow.	
25 <u>Final Subdivision Map</u> . Unless the City conveys the applicable portion of the Property by metes and bounds, the Developer shall apply for and obtain the City's approval of the Final Subdivision Map. [DDA § 2.18]	No later than the Pre-Lease Deadline or Close of Escrow, whichever is first.	
26 <u>Completion Guaranty Agreement</u> . The Developer shall deliver the Completion Guaranty Agreement to the City. [DDA §2.16]	No later than Close of Escrow.	
27 <u>Insurance</u> . The Developer shall submit evidence of insurance to the City. [DDA § 3.21]	No later than <b>30</b> days before the Pre-Lease Deadline or Close of Escrow, whichever is first.	
28 <u>Evidence of Availability of Funds</u> . The Developer shall submit evidence to the City of the availability of funds to lease the Property and construct the Improvements. [DDA § 2.13]	No later than the Pre-Lease Deadline or Close of Escrow, whichever is first.	

<u>Action</u>	<u>Date</u>	<u>Date Completed</u>
<p>29 <u>Certified copies of limited liability company, limited partnership or corporate authorizing resolutions.</u> Developer shall provide certified copies of limited liability company, limited partnership or corporate authorizing resolutions. [DDA §§ 4.3(b)(1), 9.16]</p>	<p>No later than Close of Escrow.</p>	
<p>30 <u>Close of Escrow.</u> The Permitted Lessees shall lease the Property from the City. [DDA § 4.1]</p>	<p>No later than Pre-Lease Deadline, provided that the Developer has satisfied all requirements set forth above, as reasonably determined by the City.</p>	
<p>31 <u>Commencement of Construction.</u> The Permitted Lessees shall commence construction of the Improvements. [DDA § 5.2; Leases]</p>	<p>No later than <b>[30]</b> days following Close of Escrow.</p>	
<p>32 <u>Completion of Construction.</u> The Permitted Lessees shall complete construction of the Improvements. [DDA § 5.3; Leases]</p>	<p>No later than the earlier of 40 months following the Commencement of Construction and July 31, 2024.</p>	

1-8-2020

Exhibit B

**GROUND LEASE  
2012 BERKELEY WAY  
(Berkeley Way BRIDGE Affordable Apartments)**

by and between

**CITY OF BERKELEY  
("Landlord")**

and

**BRIDGE Berkeley Way LP, a California Limited Partnership**

**("Tenant")**

Dated \_\_\_\_\_, 2020

TABLE OF CONTENTS  
(Ground Lease - Berkeley Way BRIDGE Affordable Apartments)

	Page
ARTICLE 1. OVERVIEW AND GENERAL .....	1
<b>1.1 Overview</b> .....	1
<b>1.2 Ground Lease and Possession</b> .....	1
<b>1.3 Ownership of Premises Improvements</b> .....	1
<b>1.4 Changes to Premises and Parcel Map</b> .....	2
<b>1.5 Tenant’s Organizational Documents</b> .....	2
ARTICLE 2. GROUND LEASE TERM .....	2
<b>2.1 Term</b> .....	2
ARTICLE 3. RENT .....	2
<b>3.1 Rent</b> .....	2
<b>3.2 No Cost to Landlord: No Counterclaim, No Abatement</b> .....	2
<b>3.3 Additional Rent</b> .....	2
<b>3.4 Additional Consideration</b> .....	3
ARTICLE 4. TAXES AND ASSESSMENTS; SERVICES AND UTILITIES .....	3
<b>4.1 Impositions</b> .....	3
<b>4.2 Statement Regarding Possessory Interest Tax</b> .....	4
<b>4.3 Services and Utilities</b> .....	4
ARTICLE 5. DEVELOPMENT OF PREMISES IMPROVEMENTS; ALTERATIONS .....	4
<b>5.1 General</b> .....	4
<b>5.2 Commencement and Completion of Construction</b> .....	4
<b>5.3 Prior Development Matters</b> .....	5
<b>5.4 Non-Responsibility of Landlord</b> .....	5
<b>5.5 No Change in Project Documents</b> .....	5
<b>5.6 Alterations</b> .....	6
<b>5.7 Construction Standards</b> .....	6
<b>5.8 Protection of Landlord</b> .....	8
<b>5.9 Liens and Stop Notices</b> .....	8
<b>5.10 Notice</b> .....	8
<b>5.11 Miscellaneous</b> .....	8
ARTICLE 6. USE OF PREMISES, COMPLIANCE WITH LAWS .....	9
<b>6.1 General</b> .....	9
<b>6.2 Governmental Requirements</b> .....	9
<b>6.3 Tenant’s Right to Contest</b> .....	10
<b>6.4 Nuisance</b> .....	10



TABLE OF CONTENTS  
(Ground Lease - Berkeley Way BRIDGE Affordable Apartments)

	Page
6.5 General Use Prohibitions .....	10
6.6 Non-Discrimination .....	10
6.7 General Standards of Maintenance .....	11
6.8 Landlord’s Status as a Landowner .....	11
6.9 Regulatory Approvals Generally .....	11
ARTICLE 7. CONDITION OF PREMISES; HAZARDOUS MATERIALS; LANDLORD’S RIGHT OF ENTRY .....	12
7.1 Landlord’s Disclaimers and Tenant’s Acknowledgements .....	12
7.2 Hazardous Materials .....	12
7.3 Landlord’s Right to Enter Premises and Premises Improvements .....	13
ARTICLE 8. OWNERSHIP OF IMPROVEMENTS AND PERSONAL PROPERTY .....	13
8.1 Ownership of Premises Improvements During Term .....	13
8.2 Ownership of Premises Improvements at Termination or Expiration .....	13
8.3 Removal and Ownership of Personal Property at Termination or Expiration .....	13
ARTICLE 9. INSURANCE AND INDEMNITY .....	14
9.1 General Insurance Requirements .....	14
9.2 Indemnity .....	15
ARTICLE 10. DAMAGE OR DESTRUCTION .....	16
10.1 Restoration .....	16
10.2 Waiver .....	17
10.3 Determination of Extent of Destruction, Interference with Use .....	17
10.4 Procedures for Repair and Restoration .....	17
ARTICLE 11. CONDEMNATION .....	18
11.1 Definitions .....	18
11.2 Parties’ Rights and Obligations to be Governed by Ground Lease .....	18
11.3 Total Taking .....	18
11.4 Effect of Partial Taking .....	18
11.5 Restoration of Premises Improvements .....	18
11.6 Waiver of CCP Section 1265.130 .....	19
11.7 Award .....	19
ARTICLE 12. ASSIGNMENT AND SUBLETTING .....	19
12.1 Assignment .....	19
12.2 Subleases .....	20

TABLE OF CONTENTS  
(Ground Lease - Berkeley Way BRIDGE Affordable Apartments)

	Page
ARTICLE 13. TENANT DEFAULTS AND LANDLORD'S REMEDIES .....	20
13.1 Defaults by Tenant.....	20
13.2 Remedies.....	21
13.3 Damages.....	22
13.4 Landlord's Right to Cure Tenant's Default.....	22
13.5 Guarantor Performance Under Completion Guaranty.....	22
ARTICLE 14. MORTGAGEE PROTECTION PROVISIONS.....	22
14.1 Right to Encumber.....	22
14.2 Leasehold Mortgagee as Third Party Beneficiary.....	23
14.3 Notice to Leasehold Mortgagee.....	23
14.4 Right of Leasehold Mortgagee to Cure.....	23
14.5 Limitation on Liability of Leasehold Mortgagee.....	24
14.6 Estoppel Certificates.....	24
14.7 Registration of Leasehold Mortgages.....	25
14.8 New Ground Lease.....	25
14.9 Rights of Investor.....	25
14.10 Transfers.....	26
14.11 [Intentionally Omitted].....	26
14.12 Further Ground Lease Amendments.....	26
ARTICLE 15. MISCELLANEOUS.....	26
15.1 Holding Over.....	26
15.2 Attorneys' Fees.....	26
15.3 Quiet Possession.....	26
15.4 Force Majeure.....	27
15.5 Notices.....	27
15.6 Waiver.....	27
15.7 Surrender.....	27
15.8 Binding.....	27
15.9 Disclaimer of Partnership.....	28
15.10 Quitclaim.....	28
15.11 Interpretation.....	28
15.12 Severability.....	28
15.13 Computation of Time.....	28

TABLE OF CONTENTS  
(Ground Lease - Berkeley Way BRIDGE Affordable Apartments)

	Page
15.14 Legal Advice.....	28
15.15 Time of Essence.....	29
15.16 Nonliability of Officials, Employees, etc.....	29
15.17 Assignment by Landlord .....	29
15.18 Applicable Law .....	29
15.19 Covenants and Conditions.....	29
15.20 Integration .....	29
15.21 Amendments to this Ground Lease.....	29
15.22 Proprietary and Governmental Roles: Actions by City .....	30
15.23 City Manager Authority and Limitations.....	30
15.24 Brokerage Commissions .....	30
15.25 City Non-Discrimination Ordinance.....	30
15.26 Non-Discrimination Against Persons With Disabilities.....	31
15.27 Conflict of Interest Prohibited.....	31
15.28 Nuclear Free Berkeley .....	31
15.29 Required Accessibility Disclosure.....	31
15.30 Oppressive States.....	32
15.31 Berkeley Living Wage Ordinance (LWO).....	32
15.32 Berkeley Equal Benefits Ordinance (EBO).....	33
15.33 Audit .....	34
15.34 City Business License, Payment of Taxes, Tax I.D. Number .....	34
15.35 Survival.....	34

TABLE OF CONTENTS  
(Ground Lease - Berkeley Way BRIDGE Affordable Apartments)

Page

LIST OF EXHIBITS

<u>Exhibit A</u>	Premises Legal Description
<u>Exhibit B</u>	Development Site Parcel Map
<u>Exhibit C</u>	Status of Certain DDA Provisions
<u>Exhibit D</u>	Site Reciprocal Easement Agreement (REA 1)
<u>Exhibit E</u>	City Resolution No. AAAA-N.S. [ <b><i>Approving the final Leases</i></b> ]
<u>Exhibit F</u>	Initial Leasehold Mortgages and Mortgagees
<u>Exhibit G</u>	City Financing Documents

**BASIC LEASE INFORMATION**  
**(Ground Lease - Berkeley Way BRIDGE Affordable Apartments)**

1. **“Landlord”**

CITY OF BERKELEY, a Charter city

Notice Address:

City of Berkeley  
2180 Milvia Street  
Berkeley, California 94704  
Attention: City Manager  
Telephone: (510) 981-7000  
Facsimile: (510) 981-7099

With a copy to:

City of Berkeley  
2180 Milvia Street, 4<sup>th</sup> floor  
Berkeley, California 94704  
Attention: City Attorney  
Telephone: (510) 981-6991  
Facsimile: (510) 981-6960

And

City of Berkeley HHCS  
2180 Milvia Street, 2<sup>nd</sup> floor  
Berkeley, California 94704  
Attention: Housing & Community Services Manager  
Telephone: (510) 981-5400  
Facsimile: (510) 981-5450

2. **“Tenant”**

BRIDGE Berkeley Way

Notice Address:

BRIDGE Berkeley Way LP  
c/o BRIDGE Housing Corporation  
600 California Street, Suite 900  
San Francisco, CA 94108  
Attn: General Counsel

3. **“Ground Lease Date”**

The date set forth in the first paragraph below.

4. **“DDA”**

That certain Disposition and Development Agreement (Berkeley Way Development), originally dated June 8, 2016 between Landlord and Bridge Housing Corporation, a California nonprofit public benefit corporation, as amended by First Amendment to Disposition and Development Agreement dated August 27, 2018, as partially assigned to BFHP Hope Center LP pursuant to that certain Partial Assignment and Assumption Agreement dated December 17, 2018 and recorded in Official Records of Alameda County on December 21, 2018 as Instrument No. 18-241567, as amended by the Second Amendment to Disposition and Development Agreement, dated February 1, 2019 and recorded in

**BASIC LEASE INFORMATION**  
**(Ground Lease - Berkeley Way BRIDGE Affordable Apartments)**

Official Records of Alameda County on February 14, 2019 as Instrument No. 2019029062, and as further partially assigned to Tenant and amended pursuant to that certain Assignment and Third Amendment to DDA dated \_\_\_\_\_, 2020 and recorded in Official Records of Alameda County on \_\_\_\_\_, 2020 as Instrument No. \_\_\_\_\_. See **Exhibit C** hereto.

5. **“Premises”**

The Premises is described in **Exhibit A**, being primarily Parcel C of the Parcel Map (defined below).

6. **“Development Site” or “Site”**

That certain approximately 1-acre (approximately 41,000 square feet) parcel of real property generally located at 2012 Berkeley Way, between Milvia Street and Shattuck Avenue (previously APN 57-2053-22-1) in the City of Berkeley, which is the subject of the DDA.

The Development Site has been divided into three parcels, pursuant to that certain Parcel Map 11051, filed \_\_\_\_\_, 2020 in Book \_\_\_ of Parcel Maps, Pages \_\_\_ and \_\_\_, Alameda County Records (the **“Parcel Map”**), a copy of which is attached hereto as **Exhibit B**. Generally, the three parcels are the **“BRIDGE Affordable Parcel”** (Parcel Map Parcel C), the **“Permanent Supportive Housing Parcel”** (Parcel Map Parcel A), and the **“Temporary Housing Parcel”** (Parcel Map Parcel B).

7. **“Development” or “Project”**

The entire development project to be planned, entitled, developed, financed, designed, constructed, operated and maintained on the Development Site. The overall Development is a six story building with approximately 140,000 square feet of gross interior floor space, with associated landscaping and hardscape, and includes:

- The Temporary Housing Parcel and the Temporary Housing Improvements. The **“Temporary Housing Improvements”** consists of approximately 44 beds of temporary housing, a services center and administrative office space. The Temporary Housing Improvements are located within the Temporary Housing Parcel.
- The Permanent Supportive Housing Parcel and the Permanent Supportive Improvements. The **“Permanent Supportive Housing Improvements”** consist of approximately 53 permanent supportive housing units and supportive service spaces. The Permanent Supportive Housing Improvements are located within the Permanent Supportive Housing

**BASIC LEASE INFORMATION**  
**(Ground Lease - Berkeley Way BRIDGE Affordable Apartments)**

Parcel.

- The BRIDGE Affordable Parcel and the BRIDGE Improvements. The “**BRIDGE Improvements**” consist of 89 affordable housing units (including one manager’s unit) and related improvements. The BRIDGE Improvements are located within the BRIDGE Affordable Parcel.

8. “**Permitted Use**” Affordable housing, subject to the Regulatory Requirements and all other provisions of this Ground Lease.

9. “**Premises Improvements**” The BRIDGE Improvements, collectively, together with all additions, alterations, modifications, replacements and improvements from time to time pursuant to this Ground Lease.

10. “**REA 1**” or “**Site REA**” or “**Berkeley Way REA**” That certain Declaration of and Agreement Regarding Covenants, Conditions and Restrictions Providing for Reciprocal Easements, Joint Use and Maintenance for Berkeley Way, dated \_\_\_\_\_, 2020, executed by the City of Berkeley and BRIDGE Berkeley Way LP and BFHP Hope Center LP, and recorded in Alameda County Records on \_\_\_\_\_, 2020 as Instrument No. \_\_\_\_\_, substantially in form attached hereto as **Exhibit D**.

11. [Intentionally Omitted]

12. “**Regulatory Requirements**” Includes, collectively, (i) that certain Regulatory Agreement and Declaration of Restrictive Covenants (Berkeley Way BRIDGE Affordable Apartments), dated \_\_\_\_\_, 20\_\_, between Landlord and Tenant and recorded in Official Records of Alameda County on \_\_\_\_\_, 2020 as Instrument No. \_\_\_\_\_, and any amendments approved by Landlord and Tenant, and (ii) any regulatory or affordability agreement or other covenant, condition or restriction in favor of Landlord and recorded against the Premises.

13. “**Leasehold Mortgage,**” “**Permitted Leasehold Mortgagee**” and “**Senior Leasehold Mortgagee**” As identified in **Exhibit F** attached hereto. See also ARTICLE 14 below.

14. “**Investor(s)**” **[to be provided, including notice addresses]**

**BASIC LEASE INFORMATION**  
**(Ground Lease - Berkeley Way BRIDGE Affordable Apartments)**

15. **“Term”** The period of time commencing on the Ground Lease Date and ending on the last day of the month in which the 75<sup>th</sup> anniversary of the Ground Lease Date occurs, subject to earlier termination as provided elsewhere in this Ground Lease.
16. **“Developer”** BRIDGE Housing Corporation, a California nonprofit public benefit corporation.
17. **[Intentionally Omitted]**
18. **“JDA”** Joint Development Agreement, dated \_\_\_\_\_, 20\_\_ between Tenant and BFHP Hope Center LP, a California limited partnership.
19. **“Developer Agreement”** Prior to the Ground Lease Date, the Development Services Agreement, dated \_\_\_\_\_, 20\_\_ among Developer, Tenant and BFHP Hope Center LP, a California limited partnership; and after the Ground Lease Date the Development Services Agreement, dated \_\_\_\_\_, 20\_\_ between Developer and Tenant.
20. **“Construction Schedule”** The final approved Construction Schedule for the Premises and Project, as amended from time to time pursuant to ARTICLE 5 below.
21. **[Intentionally Omitted]**
22. **“Premises Substantial Completion”** Obtaining a temporary certificate of occupancy for the Premises and Project.
23. **“Premises Substantial Completion Date”** The earlier of 40 months following the commencement of Project construction and July 31, 2024.
24. **“Guarantor” and “Completion Guaranty”** Developer, as **[Guarantor]** under that certain **[Construction Completion Guaranty]** in favor of the Landlord, dated on or about the Ground Lease Date, together with such changes as Landlord may approve.
25. **“Base Rent”** \$500 for the entire Term.
26. **“Additional Rent”** Is defined in Section 3.3 below.
27. **“Interest Rate”** The maximum rate permitted under Section 1(2) of Article XV of the California Constitution.
28. **“County”** The County of Alameda, California.





**GROUND LEASE  
2012 BERKELEY WAY  
(Berkeley Way BRIDGE Affordable Apartments)**

THIS GROUND LEASE (“**Ground Lease**”) is made and entered into this \_\_\_ day of \_\_\_\_\_, 2020 (the “**Ground Lease Date**”), by and between the Landlord and Tenant identified in the Basic Ground Lease Information, who agree as follows:

**ARTICLE 1.  
OVERVIEW AND GENERAL**

**1.1 Overview.**

A. General Purpose of Development; Authority. Landlord owns the Site. Landlord entered into the DDA to cause the construction and operation of the Development on the Site for temporary, affordable and permanent supportive housing, and homeless services to help address the City’s homeless and affordability crisis, existing as of the Ground Lease Date. This Ground Lease facilitates one component of the Development. Landlord is entering into two additional ground leases, with an affiliate of Tenant, to implement the other two components of the Development, which components are further described in Basic Lease Information Section 7. In the event of a conflict between the DDA and this Ground Lease, this Ground Lease supersedes the DDA and will control. (See also Exhibit C hereto.) Landlord’s execution of this Ground Lease and the additional ground leases was authorized by City Council Resolution No. AAAA-N.S. attached hereto as Exhibit E.

B. Specific Purpose of Ground Lease. Landlord is entering into this Ground Lease to permit Tenant to construct, operate and maintain the Premises Improvements for the Permitted Use.

C. Regulatory Requirements. The parties intend that the Regulatory Requirements will survive for the full term therein, notwithstanding any prior termination or expiration of this Ground Lease or (except as provided in ARTICLE 14) foreclosure of any Permitted Leasehold Mortgage.

D. City Financing Documents. Nothing in this Ground Lease shall limit any City right under any regulatory or financing agreements between the City and Tenant (or by Tenant for the benefit of City), or under any Regulatory Requirement.

**1.2 Ground Lease and Possession.** For and in consideration of the payment of Rent and the performance of all the covenants and conditions of this Ground Lease, as of the Ground Lease Date Landlord hereby leases and demises to Tenant, and Tenant hereby leases and hires from Landlord, the Premises, for the Term and upon the covenants and conditions set forth herein. On the Ground Lease Date, Tenant shall obtain exclusive possession of the Premises.

**1.3 Ownership of Premises Improvements.** At all times during the Term of this Ground Lease, (i) the Premises Improvements shall be owned by Tenant, (ii) Tenant alone shall be entitled to all of the tax attributes of ownership, including, without limitation, the right to claim depreciation or cost recovery deductions and the right to claim the low-income housing tax credit described in Section 42 of the Internal Revenue Code of 1986, as amended, and (iii)

Tenant shall have the right to amortize capital costs and to claim any other federal or state tax benefits attributable to the Premises Improvements.

**1.4 Changes to Premises and Parcel Map.** Tenant shall not alter the definition of the Premises, modify the Parcel Map, or further subdivide, by map, subdivision map, or otherwise, the Premises or any portion thereof, without the prior written consent of Landlord, which Landlord may grant or withhold in its sole discretion. Nothing in this Section shall prevent Tenant from entering into residential leases as provided herein and in the Regulatory Agreement.

**1.5 Tenant's Organizational Documents.** Tenant has previously provided Landlord with correct and complete copies of organizational documents for itself and (as applicable) its general partner(s) and managing member(s), including without limitation articles of organization, certificates of limited partnership, limited partnership agreements, limited liability company agreements, and the like. Tenant will provide Landlord copies of all amendments and modifications promptly following adoption thereof, and copies of such other organizational documents as Landlord may reasonably request from time to time. Any such amendment or modification which materially alters Landlord's rights herein (such as by giving new rights to Investors), or under the Site REA or Regulatory Requirements is subject to Landlord's reasonable consent.

## **ARTICLE 2. GROUND LEASE TERM**

**2.1 Term.** The Term of this Ground Lease shall be as set forth in the Basic Ground Lease Information.

## **ARTICLE 3. RENT**

**3.1 Rent.** Tenant shall pay the Base Rent specified in the Basic Ground Lease Information on or before the Ground Lease Date. Base Rent and any Additional Rent (collectively, "**Rent**") shall be paid without notice or demand, and, except as specifically provided for in this Ground Lease, without offset, deduction or credit. All Rent (other than Additional Rent payable to entities other than Landlord) shall be payable in lawful money of the United States to Landlord at the address stated herein or to such other persons or at such other places as Landlord may designate from time-to-time in writing.

**3.2 No Cost to Landlord: No Counterclaim, No Abatement.** Except as otherwise expressly provided in this Ground Lease, all Rent payable under this Ground Lease shall be absolutely net to Landlord. Except as otherwise expressly provided in this Ground Lease, Tenant shall pay Rent without assertion of any counterclaim, setoff, deduction or defense and without abatement, suspension, deferment, diminution or reduction.

**3.3 Additional Rent.** "**Additional Rent**" means all sums, Impositions (as defined in Section 4.1 below), costs, expenses, and other payments for which Tenant is responsible pursuant to this Ground Lease. Tenant's obligation to pay Additional Rent shall begin to accrue on the Ground Lease Date and shall continue to accrue throughout the Term. Additional Rent shall be payable by Tenant to the appropriate party on or before the date required by this Ground Lease. In addition to and not by way of limitation of Landlord's rights under specific provisions of this Ground Lease, Landlord shall at all times have the right (at its

sole election and without any obligation to do so) to advance on behalf of Tenant any amount, subject to Tenant's right to contest such charges and provided that (except in case of emergency calling for immediate payment) Landlord shall first have given Tenant no less than 10 business days' advance written notice of Landlord's intent to advance such amounts on behalf of Tenant. No advance by Landlord shall operate as a waiver of any Landlord right under this Ground Lease and Tenant shall remain fully responsible for the performance of its obligations under this Ground Lease. All amounts advanced by Landlord as provided in this Section shall constitute "**Additional Rent**" under this Ground Lease, shall be due and payable by Tenant to Landlord within five business days of Tenant's receipt of an invoice from Landlord therefor, and shall bear interest at the Interest Rate until paid in full.

**3.4 Additional Consideration.** In addition to the Rent and Additional Rent provided for herein, consideration for this Ground Lease shall also be and is Tenant's full and complete compliance with all terms, conditions, warranties and covenants contained in the Regulatory Requirements and this Ground Lease relating to the planning, entitling, developing, financing, designing, constructing, operating and maintaining the Premises and Premises Improvements.

#### **ARTICLE 4. TAXES AND ASSESSMENTS; SERVICES AND UTILITIES**

**4.1 Impositions.** Tenant shall pay or cause to be paid, when due to the proper authority, any and all valid taxes, assessments, impositions, fees and similar charges on the Premises or Premises Improvements which become effective after the Ground Lease Date, including all taxes levied or assessed on the possession, use or occupancy of the Premises (as distinguished from the ownership of the Premises), and all taxes levied or assessed on the ownership, possession, use or occupancy of the Premises Improvements (collectively, "**Impositions**"). Tenant shall not permit any Impositions to become a defaulted lien on the Premises or Premises Improvements; provided, however, that in the event any Imposition is payable in installments, Tenant may make, or cause to be made, payment in installments; and, provided further, that Tenant may contest the legal validity or the amount of any tax, assessment, imposition, fee or similar charge, through such proceedings as Tenant considers necessary or appropriate, and Tenant may defer the payment thereof so long as the validity or amount thereof shall be contested by Tenant in good faith and without expense to the Landlord. In the event of any such contest, Tenant shall protect, defend and indemnify the Landlord against all loss, cost, expense or damage resulting there from, and should Tenant be unsuccessful in any such contest, Tenant shall forthwith pay, discharge, or cause to be paid or discharged, such tax, assessment, imposition, fee or other similar charge. Landlord hereby consents to and shall reasonably cooperate and assist with Tenant applying for and obtaining any applicable exemptions from taxes or assessments levied on the Premises, the Premises Improvements and on Tenant's interest therein. Tenant shall have no obligation to pay Impositions pursuant to this Section that are due and payable prior to the Ground Lease Date, including without limitation any taxes, assessments, impositions, fees or other charges levied against the Premises which are incurred prior to the Ground Lease Date. Any Imposition relating to a period, only a part of which is included within the Term, shall be prorated as between Landlord and Tenant so that Landlord shall pay (if Landlord is subject to such Impositions) the portion of Impositions attributable to any period prior to the Ground Lease Date or subsequent to the expiration of this Ground Lease, and Tenant shall pay the portion thereof attributable to any period during the Term. Nothing contained in this Ground Lease shall be deemed to require the payment by Tenant of any income, franchise, estate, inheritance, succession or capital levy tax of Landlord.

**4.2 Statement Regarding Possessory Interest Tax.** This Ground Lease creates a possessory property interest in Tenant. Tenant acknowledges and agrees that Tenant's leasehold and/or other real property interests may be subject to property taxation, and Tenant or the party in whom the possessory property interest is vested may be subject to the payment of property taxes levied on the interest. Such taxes (unless Tenant establishes an exemption) shall be paid by Tenant as part of Impositions as provided in this Ground Lease.

**4.3 Services and Utilities.** Tenant shall pay, or cause to be paid, all charges that are incurred by Tenant or that might be a charge or lien against the Premises or Premises Improvements for gas, water, electricity, telephone or other communication service, janitorial service, debris removal, or any other utility or service used, rendered or supplied upon or in connection with the Premises Improvements, throughout the Term ("**Utilities**"). Such charges shall include the cost of installing and metering such utility services. Tenant shall maintain, repair and (if necessary) replace all Utility facilities and installations in, on, about or otherwise serving the Premises or Premises Improvements. Landlord grants to Tenant the right to grant to public entities or public service corporations, for the purpose of serving only the Premises during the Term of this Ground Lease, rights-of-way or easements on or over the Site, for poles or conduits or both, and for other utilities and municipal or special district services; provided, however, that Tenant shall not grant any such rights of way or easements that would adversely affect or create safety problems in connection with the use or operation, or access to and from, the Permanent Supportive Housing Parcel or Temporary Housing Parcel, or any adjoining property. Landlord shall join in the execution of or consent to any such any such rights of way or easements. Tenant shall promptly provide to Landlord copies of all rights-of-way and easements so granted. Tenant, or third parties other than Landlord, shall bear all costs and expenses incurred in connection with the granting of any such rights-of-way and easements.

**ARTICLE 5.  
DEVELOPMENT OF PREMISES IMPROVEMENTS; ALTERATIONS**

**5.1 General** Tenant shall plan, entitle, develop, finance, design and construct the Premises Improvements on the Premises pursuant to and in compliance with all the terms and conditions set forth in DDA Article 5, this ARTICLE 5, the JDA, the Developer Agreement and the Construction Schedule. In the event of any conflict between this Ground Lease and the DDA, this Ground Lease shall control. Without limiting the foregoing:

A. Tenant shall notify Landlord regarding (i) any material breaches or defaults, and (ii) any schedule issues that may impair Tenant's ability to substantially complete the Premises Improvements prior to the date contained in the latest Construction Schedule; and

B. Tenant shall require its General Contractor performing the initial construction of the Premises Improvements to prepare all schedule updates required by the Construction Contract and promptly provide copies to Landlord.

**5.2 Commencement and Completion of Construction.** Tenant shall commence construction of the Premises Improvements no later than 30 days following the Ground Lease Date, and shall use diligent efforts to complete construction (subject to Force Majeure delays as defined in delays as defined in Section 15.4 below) no later than the Premises Substantial Completion Date. As between Tenant and Landlord, Tenant shall bear all costs and expenses to complete, or cause the completion of, the Premises Improvements within the time period set forth in the Construction Schedule, including without limitation any cost

overruns and changes (regardless of Landlord's approval of any changes) for the Premises Improvements.

### **5.3 Prior Development Matters**

A. Site and Title Approvals. By its execution and delivery of this Ground Lease, Tenant confirms that it has approved all matters relating to the Site and title matters, as provided in DDA Sections 2.6, 2.7 and 4.5.

B. City and Governmental Approvals; CEQA Litigation. By its execution and delivery of this Ground Lease, Tenant and Landlord confirm that Tenant has obtained all City Approvals (as defined in the DDA). Tenant confirms that it has obtained all other governmental approvals necessary for the development and operation of the Premises and the Premises Improvements, as provided in DDA Section 2.11. If any third party commences litigation objecting to or otherwise challenging any action or omission under California Environmental Quality Act (“**CEQA**”) with respect to the Premises or any of Landlord's land use approvals relating to this Ground Lease, the Premises Improvements or the use or occupancy thereof, Tenant shall indemnify, hold harmless and defend Landlord (with defense counsel selected by Tenant and reasonably acceptable to Landlord) for any and all liabilities, losses, costs or expenses, including attorney fees or fees for the use of experts or consultants, incurred as a result of any such claim, litigation or challenge. No settlement shall be entered into without Landlord's full consent and approval.

C. Construction Drawings and Specifications. By its execution and delivery of this Ground Lease, Tenant and Landlord confirm that Tenant has obtained all required City approvals for the Final Construction Drawings in accordance with DDA Sections 2.17 and 3.4.

**5.4 Non-Responsibility of Landlord.** Tenant shall be solely responsible for all aspects of its conduct in connection with the Premises Improvements, including, but not limited to, the quality and suitability of the final drawings and specifications, the supervision of construction work, and the qualifications, financial condition, and performance of all architects, engineers, contractors, subcontractors, suppliers, consultants, and property managers. Any review, inspection or approval undertaken by Landlord is solely for the purpose of determining whether the Tenant is properly discharging its obligations to Landlord, and should not be relied upon by Tenant, Developer or any other third parties as a warranty or representation by Landlord as to the quality of the design or construction of the Premises Improvements.

**5.5 No Change in Project Documents.** From and after the Ground Lease Date until Premises Substantial Completion, except as set forth in DDA Section 5.1, Tenant shall not make any Material Change to the Final Construction Drawings or permit others to make any Material Change without the Landlord's prior written approval. As used in this Section 5.5 “**Material Change**” means (i) any change in the work the cost of which exceeds Two Hundred Fifty Thousand Dollars (\$250,000); or (ii) any set of changes in the work the cost of which cumulatively exceeds Five Hundred Thousand Dollars (\$500,000); or (iii) any material change in building materials or equipment, or the structural or architectural design or appearance of the Development as provided for in the plans and specifications approved by the City Building Department. From and after the Ground Lease Date until Premises Substantial Completion, Tenant shall not make any changes to the Construction Schedule or permit others to do so, without the Landlord's prior written approval, which shall not unreasonably be withheld.

**5.6 Alterations.**

A. Alterations shall also be governed by this Ground Lease, including without limitation applicable provisions of this ARTICLE 5. “**Alterations**” include modifications or additions to the Premises Improvements following Premises Substantial Completion, including without limitation Material Alterations. “**Material Alterations**” means (a) the construction of any new additional building or structure, (b) an increase in the bulk or height of the Premises Improvements, (c) any material alteration of exterior architectural designs, colors or materials (unless the applicable exterior component is not reasonably available or does not meet current code requirements, and Tenant uses materials of equal quality, durability, design standards, and appearance to the materials originally installed), or (d) reconstruction following fire or other casualty in excess of \$300,000 (subject to adjustment pursuant to the CPI from and after the Ground Lease Date). Any Alterations shall be in compliance with applicable Laws and permits, shall at all times be of first-class construction and architectural design. Material Alterations shall be in accordance with all plans and specifications therefor submitted to and approved by Landlord as set forth below. No material changes to such approved plans and specifications shall be made without Landlord’s prior written approval. All Alterations shall be diligently prosecuted, completed, and accomplished without cost or expense to Landlord, by licensed contractors, and in a first-class and workmanlike manner.

B. Except with Landlord’s prior written consent, which may be granted or denied in Landlord’s reasonable discretion, Tenant shall not make or cause to be made any Material Alterations as set forth below. If Tenant at any time following Premises Substantial Completion desires to undertake any Material Alterations, Tenant shall, prior to the commencement of such work, prepare or cause to be prepared, at its sole expense, and shall submit to Landlord for its review, cost estimates, plans and specifications for such work, showing, without limitation, scaled elevations, scaled floor plans, design concepts, dimensions, material selection, colors, signing (if any) and such additional information as is reasonably requested by Landlord to make an informed decision on such submission. The plans and specifications shall comply with this Ground Lease and shall be in compliance with applicable Laws. Landlord shall approve or disapprove such submitted plans within 30 days of receipt of complete plans and specifications meeting the requirements of this subsection. In the event Landlord disapproves a submittal pursuant to this Section, Landlord shall submit a list of reasons for the disapproval to the Tenant together with its notice of such disapproval. Failure of the Landlord to approve or disapprove such plans and specifications within such 30-day period shall be deemed to be Landlord’s disapproval. Nothing herein or in any other agreement relating to the Development shall require Landlord to approve Material Alterations which would cause the Building (including any solar canopy or other energy facilities) to be greater than 206 feet high or include more than 167,000 interior square feet.

**5.7 Construction Standards.** The following standards (as applicable) shall apply to the design and construction of all Premises Improvements and Alterations under this Ground Lease.

A. Approval of Contractor and Materials. Landlord’s approval of Tenant’s contractor or other person engaged to perform the work is required for all Premises Improvements and Alterations with an aggregate cost exceeding \$250,000 (subject to adjustment pursuant to the CPI from and after the Ground Lease Date) for any single instance, and for such other matters as Landlord may request from time to time.

B. Contracts, Plans and Specifications. Subject to the rights of Leasehold Mortgagees and Tenant's Investor, all contracts with any architect, other design professional or any general contractor for the original construction of the Premises Improvements or the construction of Material Alterations shall provide for the assignment thereof to Landlord as security to Landlord for Tenant's performance hereunder.

C. General Construction Standards. Except as otherwise expressly provided in this Ground Lease, all Tenant construction contractors and subcontractors shall be licensed. Tenant shall require any general contractor to institute an appropriate safety program to assure the safety and convenience of all persons. In addition, Tenant shall pay (or cause to be paid) all costs and expenses associated with Tenant's work and shall indemnify, defend and hold Landlord harmless from all liabilities, damages, losses or claims attributable to the Tenant's construction of the Premises Improvements, or of any subsequent Alterations on or about the Premises, as the case may be, and the performance of Tenant's work. Dust, noise and other effects of Tenant's work shall be controlled by Tenant as required by the applicable conditions of approval of the Premises Improvements and applicable Laws so as to minimize deleterious effects associated with construction projects in a populated or developed area. Tenant shall identify an individual representative to address any neighborhood complaints related to its construction work and Tenant shall respond promptly to any neighborhood complaints. Tenant shall be required, at Tenant's expense, to obtain any and all air quality and other permits required of Tenant in connection with Tenant's construction.

D. Public Safety. Without limiting the generality of the Subsection 5.7C above, as between Landlord and Tenant, Tenant shall have the sole responsibility for implementing all necessary safeguards for the protection of workers and the public.

E. Permits. To the extent that any Premises Improvements or Alterations require a building permit or other permits from the City of Berkeley and/or any other governmental agency, Tenant shall not perform any Alterations until Tenant has obtained all requisite permits.

F. Prevailing Wage Laws. Tenant shall comply with all prevailing wage requirements of California Labor Code Sections 1720 et seq. Tenant agrees that to the extent it is required to comply with the prevailing wage requirements, Tenant shall assure that all workers are paid the general prevailing rate of per diem wages and the general per diem prevailing rate for holiday and overtime work as defined by applicable Laws (including without limitation Labor Code Section 1773.1) in effect from time to time. Copies of the applicable prevailing rate of per diem wages are on file at Landlord's principal office and will be made available to any interested party on request. Tenant agrees to post a copy of the prevailing rate of per diem wages at the Premises. Tenant, as a penalty, shall forfeit the amount then-specified by applicable Law for each calendar day, or portion thereof (or such other sum as specified from time to time by Section 1775 of the California Labor Code or other applicable law), for each worker paid less than the applicable prevailing rates for such work or craft in which such worker is employed. Unless otherwise specified by Law, the difference between such prevailing wage rates and the amount paid to each worker for each calendar day or portion thereof for which each worker was paid less than the prevailing wage rate shall be paid to each worker by Tenant.

G. Compliance With JDA and Developer Agreement. During the initial construction of the Project, Tenant shall comply with its obligations under the JDA and Developer Agreement.



H. Insurance. See ARTICLE 9 below.

I. Utility Work. Any work performed by or on behalf of Tenant or any occupant or subtenant to connect to, repair, relocate, maintain or install any storm drain, sanitary sewer, water line, gas line, telephone conduit or any other public utility service shall be performed so as to minimize interference with the provision of such services to other property owners and occupants.

**5.8 Protection of Landlord**. Landlord shall have the right at all reasonable times to post, and keep posted, on the Premises and Premises Improvements any notices which Landlord may reasonably deem necessary for the protection of Landlord and of the Premises and Premises Improvements from mechanics' liens or other claims. Tenant shall give Landlord 10 days' prior written notice of the commencement of any Alterations that could give rise to mechanics' liens to be done on or about the Premises or Premises Improvements to enable Landlord to post such notices. In addition, Landlord may in its discretion require Tenant to furnish to Landlord at Tenant's expense reasonable improvement security, including performance and labor and materials bonds, prior to commencement of any Material Alterations. Tenant shall make, or cause to be made, prompt payment of all monies due and legally owing to all persons doing any Alterations or furnishing any materials or supplies to Tenant or any of its contractors or subcontractors in connection therewith.

**5.9 Liens and Stop Notices**. Tenant shall keep the Premises and Premises Improvements free and clear of all stop notices, mechanics' liens and other liens on account of any Alterations done for Tenant or persons claiming under it. Tenant shall indemnify and save Landlord harmless against liability, loss, damages, costs, attorneys' fees, and all other expenses on account of claims of lien of laborers or materialmen or others for Alterations performed or materials or supplies furnished to Tenant or persons claiming under it. If a claim of a lien or stop notice is given or recorded affecting the Premises or Premises Improvements, Tenant shall have the right to consent the lien. Tenant shall, within 30 days of recording of a lien or service of a stop notice:

- A. Pay and discharge the same;
- B. Affect the release thereof by recording and delivering to Landlord a lien release bond in customary form and amount which results in the removal of such lien from the Premises and Premises Improvements; or
- C. Otherwise obtain or effect the release thereof.

**5.10 Notice**. Should any claims of lien be filed against the Premises or Premises Improvements thereon, or any action be commenced affecting the title to such property, the party receiving notice of such lien or action shall forthwith give the other party written notice thereof.

**5.11 Miscellaneous**.

A. Landlord Access. Representatives of Landlord shall have the right of reasonable access to the Premises upon reasonable notice to Tenant and without charges or fees, and at normal construction hours during any construction period, for the purposes of ascertaining compliance with the terms of this Ground Lease. Landlord's access shall be reasonably exercised to minimize interference with Tenant's construction and/or operations. In

any site visits, Landlord shall comply with all safety rules of the Tenant and (except as otherwise permitted in connection with its exercise of rights under Section 6.8 below) Tenant shall have the right to accompany Landlord.

B. Guarantee of Workmanship and Materials. Tenant shall insure that any transferable warranties then in effect are transferred to Landlord upon expiration or termination of this Ground Lease.

C. Notice of Completion. Promptly upon completion of construction of the Premises Improvements and Material Alterations, Tenant shall file or cause to be filed in the Official Records of the County a Notice of Completion (the “**Notice of Completion**”), and provide a filed copy to Landlord.

D. As Built Plans and Specifications. Within 30 days following completion of construction of any construction, changes, Alteration or repair on or about the Premises for which architectural drawings and specifications are required, Tenant shall deliver to Landlord three sets (at least one of which is on CD) of “**As Built**” drawings and specifications for such work, and copies of lien waivers from all contractors, subcontractors, suppliers and materialmen involved in construction.

E. Except as otherwise expressly provided in this Ground Lease or other agreement expressly referenced herein, all Premises Improvements and Alterations shall be without cost or expense to Landlord.

## **ARTICLE 6. USE OF PREMISES, COMPLIANCE WITH LAWS**

**6.1 General.** Tenant covenants and agrees on behalf of itself and its successors and assigns that Tenant shall continuously use and operate the Premises and Premises Improvements for the Permitted Use and for no other purpose without Landlord’s prior written consent, which consent Landlord may withhold in its sole discretion. As a material condition of this Ground Lease and the City Financing Documents, Tenant shall comply and shall at all times be in compliance with the Ground Lease, the Site REA and all Regulatory Requirements. Tenant acknowledges that Landlord has entered into this Ground Lease and has agreed to the Rent structure contained herein in material reliance on Tenant’s agreement to permit only those uses described herein. In the event Tenant requests a change in any use described herein, Tenant agrees that Landlord, in its sole discretion, may withhold consent to such a request or that Landlord properly may condition consent to any change in use on a renegotiation of the Rent structure or amounts. Further, Tenant acknowledges that Landlord has determined that this use is beneficial to Landlord’s overall governmental purposes and Tenant understands that Landlord has no obligation to consent to any other use of all or any part of the Premises.

**6.2 Governmental Requirements.** Tenant, at Tenant’s expense, shall comply with all applicable Hazardous Materials Laws (as defined in Section 7.2 below), statutes, laws, codes, rules, orders, zoning, ordinances, directions, regulations, permits, or other requirements of federal, state, county, municipal, or other governmental authorities having jurisdiction, now in force or which may hereafter be in force (individually “**Law**” and collectively “**Laws**”), which shall impose any duty upon Landlord or Tenant with respect to the use, occupancy, or alteration of the Premises or Premises Improvements or any portion thereof, including those requiring alterations or additions to be made to, or safety appliances or devices

to be maintained or installed in, on or about the Premises or Premises Improvements or any portion thereof, and payment of any fees, charges or assessments arising out of or in any way related to the Premises or Premises Improvements or any portion thereof as a source of adverse environmental impacts or effects].

**6.3 Tenant's Right to Contest.** Tenant, at its sole cost and expense, shall have the right to contest, by appropriate proceedings diligently conducted in good faith in the name of Tenant, the validity or application of any applicable Law. If compliance with any applicable Law legally may be delayed pending the prosecution of any such proceeding without cost or penalty and without subjecting Landlord to any liability, civil or criminal, Tenant may delay compliance until the final determination of such proceeding.

**6.4 Nuisance.** Tenant shall not use the Premises or the Premises Improvements for any unlawful purpose and shall not perform, permit or suffer any act of omission or commission upon or about the Premises or the Premises Improvements which would result in a nuisance or a violation of the laws and ordinances of the United States, State, County or City ordinances and all agencies thereof as the same may be now or hereafter in force and effect.

**6.5 General Use Prohibitions.** Tenant covenants and agrees that in connection with the use and operation of the Premises and Premises Improvements, and any portion thereof, Tenant will not:

- A. Permit undue accumulations of garbage, trash, rubbish or any other refuse;
- B. Create, cause, maintain or permit any nuisance (as the same may be defined by Law) in, on or about the Premises or Premises Improvements;
- C. Commit or suffer to be committed any waste in, on or about the Premises or Premises Improvements;
- D. Use or allow the Premises or Premises Improvements to be used for any unlawful purpose, or for any purpose which violates the terms of any recorded instrument affecting the Premises;
- E. Cause or permit any insurance coverage on the Premises or Premises Improvements to become void or voidable or make it impossible to obtain any required insurance at commercially reasonable rates;
- F. Intentionally cause or knowingly permit any material structural damage to or deterioration of the Premises or Premises Improvements or to any adjacent public or private property or improvements; or
- G. Violate or permit any violation of any applicable Law, ordinance or regulation applicable to the Premises or Premises Improvements.

**6.6 Non-Discrimination.** Tenant covenants and agrees that there shall be no unlawful discrimination against or segregation of any person or group of persons on account of race, color, creed, religion, sex, marital status, sexual orientation, source of income, age, physical or mental handicap, medical condition, national origin or ancestry in the sublease,

transfer, use, occupancy, tenure or enjoyment of the Premises, the Premises Improvements or any portion thereof, nor shall Tenant, or any person claiming under or through Tenant, establish or permit any such unlawful practice or practices of discrimination or unlawful segregation with reference to the selection, location, number, use or occupancy of tenants, lessees, sublessees, subtenants, vendees, users or customers in the Premises, the Premises Improvements, or any portion thereof. Tenant shall refrain from unlawfully restricting the use, occupancy, rental or sublease of the Premises, the Premises Improvements, or any portion thereof on account of race, color, creed, religion, sex, marital status, sexual orientation, source of income, age, physical or mental handicap, medical condition, national origin or ancestry of any person.

**6.7 General Standards of Maintenance.** Tenant covenants and agrees that it shall maintain, or cause to be maintained, the Premises, the Premises Improvements, and all improvements and landscaping within the Premises in a good, safe condition and repair, subject only to normal wear and tear, and in full compliance with Site REA all applicable Laws, and this Ground Lease.. To accomplish such maintenance, Tenant shall either staff or contract with and hire licensed and qualified personnel to perform such maintenance work, including the provision of labor, equipment, materials, support facilities, and any and all other items necessary to comply with the requirements of this Section. All maintenance work shall conform to all applicable Federal and State Occupation Safety and Health Act standards and regulations for the performance of maintenance.

**6.8 Landlord's Status as a Landowner.** Tenant understands and agrees that Landlord is entering into this Ground Lease in its capacity as a landowner with a proprietary interest in the Premises and Premises Improvements and not as a regulatory authority with certain police powers. Landlord's legal status shall in no way limit the obligation of Tenant to obtain any required approvals from Landlord's departments, boards or commissions that have jurisdiction over the Premises or Premises Improvements. By Landlord's entering into this Ground Lease, neither Landlord nor any of Landlord's Council, boards, commissions, agencies, departments, or affiliates obligates itself to any other governmental agent, board, commission or agency, or to Tenant, or to any other individual or entity, with regard to any discretionary action relating to development or operation of the Premises, or Premises Improvements. Discretionary action includes but is not limited to rezonings, variances, environmental clearances, or any other governmental agency approvals that may be required or desirable for the improvement, alteration, or operation of the Premises, or Premises Improvements by the City in connection with its governmental capacity or police powers. By entering into this Ground Lease, Landlord is in no way modifying or limiting the obligation of Tenant to cause the Premises and Premises Improvements to be used and occupied in accordance with all Laws, nor any right of the Landlord or its Council, boards, commissions, agencies, departments, or affiliates to directly enforce Tenant's compliance with Laws. Further, nothing in this Ground Lease shall subject Landlord to liability or increase its liability in connection with any act, omission, occurrence or circumstance arising from its governmental capacity or police powers due to its status as Landlord under this Ground Lease.

**6.9 Regulatory Approvals Generally.** Tenant acknowledges and agrees that this Ground Lease does not guarantee that Landlord, in its regulatory capacity, will grant any particular request for a license, permit or other regulatory approval. Tenant understands that Landlord may grant or deny such request in its sole discretion, and may impose such terms and conditions as it deems consistent with that discretion and applicable Laws.

ARTICLE 7.

CONDITION OF PREMISES; HAZARDOUS MATERIALS; LANDLORD'S RIGHT OF ENTRY

**7.1 Landlord's Disclaimers and Tenant's Acknowledgements.** The Premises are being leased to Tenant in their current, existing, "AS-IS" condition as set forth in, and subject to, DDA Section 4.5, the terms of which are incorporated herein by reference, except that all references therein to "Developer" are replaced with "Tenant".

**7.2 Hazardous Materials**

A. General Compliance. DDA Section 6.2, the terms of which are incorporated herein by reference, with the following modifications in addition to the other modifications therein:

1. All references therein to "Developer" are replaced with "Tenant";
2. All references to "Hazardous Materials Laws" shall mean all laws, codes, rules, orders, ordinances, directives, regulations, permits, or other requirements of federal, state, county, municipal or governmental authorities having jurisdiction, now in force or which may hereafter be in force concerning the management, use, generation, storage, transportation, presence, discharge or disposal of any and all pollutants, wastes, flammables, explosives, radioactive materials, hazardous or toxic materials, hazardous or toxic wastes, hazardous or toxic substances, carcinogenic materials or contaminants and all other materials governed, monitored, or regulated by any Federal, State or local law or regulation, including but not limited to the Comprehensive Environmental Response, Compensation and Liability Act, the Hazardous Substances Account Act, and/or the Resources Conservation and Recovery Act.
3. All references to "**Hazardous Materials**" shall include asbestos, asbestos-containing materials, hydrocarbons, polychlorinated biphenyl ("**PCB**") or PCB-containing materials, petroleum, gasoline, petroleum products, crude oil or any fraction, product or by-product thereof.
4. All references to "Development" means the "Premises."
5. All references to "Term" shall mean "Term" as defined in this Ground Lease.
6. Nothing in this Ground Lease or **Exhibit C** shall limit or restrict the use of limited quantities of household cleaning products and office supplies used or stored at the Premises and required in connection with the routine operation and maintenance of the Premises, and used in compliance with (i) this Ground Lease, (ii) all applicable Hazardous Materials Laws, and (if applicable) (ii) the Project Rules (as defined in the Site REA).

B. Tenant's Independent Investigation. Tenant or its agents and representatives have undertaken investigations of the Premises in an attempt to determine if any Hazardous Material is present on the Premises. Except as disclosed in the Phase I and Phase II Environmental Assessment report dated \_\_\_\_\_, 2018 by Rincon Consultants, and ***[insert name/other information regarding additional soils testing, expected to be completed on or about December 2019]***, no Hazardous Material has been located or discovered to date and the parties agree that for purposes of this Ground Lease, Tenant assumes full responsibility for the investigation and remediation, as and to the extent required by

Environmental Laws, of all Hazardous Material in, on or under the Premises that is discovered during the Term.

**7.3 Landlord's Right to Enter Premises and Premises Improvements.**

Landlord and its authorized representatives shall have the right to enter the Premises and Premises Improvements at all reasonable times, after giving Tenant 24 hours prior written notice (except in emergency in which case no notice shall be required), for any purpose, including: to determine whether the Premises, the Premises Improvements, or any other improvements on the Premises is in good condition and whether Tenant is complying with its obligations under this Ground Lease; to do any necessary maintenance and to make any restoration to the Premises Improvements or any other improvements upon the Premises that Landlord has the right or obligation to perform; to serve, post or keep posted any notices required or allowed under the provisions of this Ground Lease and (except as otherwise permitted in connection with its exercise of rights under Section 6.8 above) Tenant shall have the right to accompany Landlord.

A. Landlord shall not be liable in any manner for any inconvenience, disturbance, loss of business, nuisance, or other damage arising out of Landlord's entry on the Premises and Premises Improvements as provided in this Section other than any property damage, bodily injury, or death caused by the sole active negligence or willful misconduct of Landlord, its agents, employees or contractors.

B. Tenant shall not be entitled to an abatement or reduction of Rent if Landlord exercises any rights reserved in this section.

**ARTICLE 8.  
OWNERSHIP OF IMPROVEMENTS AND  
PERSONAL PROPERTY**

**8.1 Ownership of Premises Improvements During Term.** During the Term, the Premises Improvements and Alterations shall be and remain the property of Tenant; provided that Tenant's rights and powers with respect to the Premises Improvements and any Alterations shall be and shall remain subject to the terms and limitations of this Ground Lease. Tenant covenants for itself and all persons claiming under or through it that the Premises Improvements is and will at all times be real property.

**8.2 Ownership of Premises Improvements at Termination or Expiration.** Upon the expiration or other termination of this Ground Lease, all improvements on the Premises, including the Premises Improvements and any Alterations shall, without compensation to Tenant, become Landlord's property free and clear of all claims to the extent caused by Tenant or any subtenant. Tenant is not obligated to remove rights arising from the Site REA. The foregoing, however, will be subject to the rights of permitted subtenants at the Premises Improvements provided that the subtenants are not then in default and they attorn to Landlord as their landlord. (See also Section 15.10.)

**8.3 Removal and Ownership of Personal Property at Termination or Expiration.** At the expiration or termination of the Term, Landlord may, at Landlord's election, require Tenant to remove from the Premises, at Tenant's sole cost and expense, all personal property (including fixtures). Tenant shall be liable to Landlord for costs incurred by Landlord in effecting the removal of such personal property (including fixtures) which Tenant has failed to remove after demand pursuant to this section.

A. Tenant and its subtenants and other permitted occupants may, from time to time during the Term, remove any personal property (other than fixtures) that may be removed without damage to the structural integrity of the Premises or Premises Improvements. Tenant shall (or shall cause its subtenants and other permitted occupants to) repair all damage caused by any such removal.

B. Any personal property owned by Tenant or its subtenants and not removed by Tenant prior to the expiration or termination of the Term shall be deemed to be abandoned by Tenant or (to the greatest extent permitted by applicable Law) its subtenants, and shall, without compensation to Tenant or (to the extent permitted by applicable Law) subtenant, become the Landlord's property, free and clear of all claims to or against them by Tenant, subtenant or any other person, but subject to the rights of third party lenders and equipment lessors as to which Landlord has notice.

## **ARTICLE 9. INSURANCE AND INDEMNITY**

### **9.1 General Insurance Requirements.**

A. During the entire Term of this Ground Lease, Tenant shall provide the following forms and amounts of insurance with respect to the Premises Improvements and the Premises. Such insurance shall be primary to and not contributing with any other insurance, self-insurance, or joint self-insurance maintained by the Landlord, shall name the Landlord as an additional insured, and shall include, but not be limited to:

1. Fire and Extended Coverage Insurance as provided the Site REA or, following the expiration or termination thereof, as Landlord may reasonably specify..

2. Broad Form Commercial General Liability Insurance in an amount not less than \$2,000,000 per occurrence and umbrella/excess liability insurance in the amount of \$5,000,000, as further provided the Site REA and this ARTICLE 9 or, following the expiration or termination thereof, as Landlord may reasonably specify. The policy shall not contain any intra-insured exclusions as between insured persons or organizations, but shall include coverage for liability assumed under this Ground Lease as an "insured contract" for the performance of Tenant's indemnity obligations under this Ground Lease. The limits of this insurance shall not, however, limit the liability of Tenant nor relieve Tenant of any obligation hereunder. .

3. Comprehensive Auto Liability Insurance with limits not less than \$2,000,000 each occurrence as further provided the Site REA and this ARTICLE 9 or, following the expiration or termination thereof, as Landlord may reasonably specify.

4. Worker's Compensation Insurance, including Employer's Liability coverage, with limits not less than \$1,000,000 each accident, to the extent required by law, as may be further provided the Site REA and this ARTICLE 9 or, following the expiration or termination thereof, as Landlord may reasonably specify.

5. Leasehold Mortgagee Insurance. Any additional policy of insurance required by any lender providing permanent financing for the Premises Improvements or any Alterations.

B. Review. The liability insurance requirements may be reviewed by Landlord every five years, for the purpose of increasing (in consultation with its insurance advisors) the minimum limits of such insurance from time to time to limits which shall be reasonable and customary for similar facilities of like size and operation in accordance with generally accepted insurance industry standards, but in no event will Tenant be required to increase the amount of cumulative or single occurrence coverage for any five-year period by more than the lesser of (i) 50% and (ii) two times the CPI increase since the last increase under this Section.

C. Insurance for Construction of Premises Improvements and Alterations. Tenant's contractors and subcontractors for the Premises Improvements shall maintain all insurance required by DDA Section 6.3(b). Tenants contractors and subcontractors for any Alterations shall maintain all liability, property worker's compensation, employee and insurance as Landlord deems reasonably necessary or as otherwise provided in this Ground Lease.

D. General. All deductibles shall be declared to and subject to Landlord's approval if in excess of \$100,000 per occurrence (as increased by CPI). All commercial general liability and automobile liability policies shall name Landlord and its officers, agents, employees, and representatives (together, "**Landlord Parties**") as additional insureds. Tenant shall furnish Landlord with a certificate of insurance evidencing the required insurance coverage and a duly executed endorsement evidencing such additional insured status. The certificate shall (to the extent reasonably obtainable) contain a statement of obligation on the part of the carrier to notify Landlord of any material change, cancellation or termination of the coverage at least 30 days in advance of the effective date of any such material change, cancellation or termination; otherwise, Tenant shall provide such notice. Upon Landlord's request, Tenant shall provide certified copies of all insurance policies, including declarations pages. Coverage provided hereunder by Tenant or its contractors shall be primary insurance and shall not be contributing with any insurance, self-insurance or joint self-insurance maintained by Landlord, and the policy shall so provide. The insurance policies shall contain a waiver of subrogation for the benefit of the Landlord and other additional insureds. The required certificate and endorsements shall be furnished by Tenant to Landlord prior to the Ground Lease Date, and prior to each anniversary thereof. If Tenant or its contractors fails to purchase, renew or maintain any insurance policies required herein, Landlord shall have the right to so purchase any such insurance and the amount of any such advance by Landlord shall constitute Additional Rent under this Ground Lease.

**9.2 Indemnity**. To the greatest extent permitted by Law (including without limitation Civil Code Section 2782 if and to the extent applicable), Tenant shall protect, indemnify, defend and hold Landlord and Landlord Parties harmless from and against any and all demands, liability, claims, actions and damages to any person or property, costs and expenses, including attorneys' fees, arising out of or connected with: (i) a default by Tenant of its obligations under this Ground Lease; (ii) the use or occupancy of the Premises Improvements, the Premises, the improvements thereon including any Alterations, or any portion thereof, by Tenant or any of its contractors, subcontractors, employees, subtenants, licensees, invitees, subtenants, assignees or Users (collectively "**Tenant's Parties**"), other than those attributable to the sole negligence or willful misconduct of Landlord or Landlord Parties; (iii) any pre-Ground Lease Date entry by or on behalf of Developer or Tenant under the Temporary Right of Entry described in DDA Section 9.19(a); and (iv) the release, use, generation, discharge, storage or disposal of any Hazardous Materials on, under, in or about, or the transportation of any such Hazardous Materials to or from, the Premises in violation, or alleged violation, of any Laws, which occurs at any time during the Term. The indemnity obligation in clause (iii) above shall include any demands, liability, claims or actions for tangible



or intangible property damage; compensation for lost wages, business income, profits or other economic loss; damage to the natural resource or the environment; nuisance; trespass; and/or contamination, leak, spill, release or other adverse effect on the environment. Tenant's indemnity obligations under this Section shall survive the expiration or termination of this Ground Lease.

**ARTICLE 10.  
DAMAGE OR DESTRUCTION**

**10.1 Restoration.**

A. Insured Damage. No loss or damage by fire or any other cause resulting in either partial or total destruction of the Premises Improvements or any other improvements now or hereafter located on the Premises, including any fixtures, personal property, equipment or machinery used or intended to be used in connection with the Premises or Premises Improvements, shall (except as otherwise provided in Sections 1.1A or 10.1B) operate to terminate this Ground Lease or to relieve or discharge Tenant from the payment of any Rent, or other amounts payable hereunder, as and when they become due and payable, or from the performance and observance of any of the agreements, covenants and conditions herein contained to be performed and observed by Tenant. Provided that Tenant determines that it is feasible to repair the Premises Improvements, and subject to the rights of Leasehold Mortgagees and Tenant's Investors, and specific procedures (if any) set forth in the Site REA, Tenant covenants to repair, reconstruct, and/or replace or cause to be repaired, reconstructed and/or replaced the Premises Improvements and any other improvements now or hereafter located on the Premises, including any fixtures, personal property, equipment or machinery used or intended to be used in connection with the Premises or Premises Improvements, so damaged or destroyed. Subject to the rights of any Leasehold Mortgagee, Tenant also covenants that all insurance proceeds will be applied to the repair, reconstruction and/or replacement described herein.

B. Premises Improvements Uninsured Damage. Notwithstanding the provisions of Section 10.1A, if, during the Term, the Premises Improvements are totally destroyed or rendered inaccessible or if the remaining portion of the Premises Improvements are rendered unsuitable (as defined herein) for Tenant's continued use, from a risk not covered 90% by the insurance required to be carried by Tenant under this Ground Lease, and either (i) the cost of restoration exceeds 50% of the then replacement value of the Premises Improvements as reasonably determined by Landlord, (ii) Tenant reasonably determines that repair and reconstruction is infeasible, or (iii) if fewer than fifteen (15) years of the Term remain, Tenant can elect to terminate this Ground Lease by giving notice to Landlord within 30 days after Landlord's determination of the restoration cost and replacement value. The Premises Improvements shall be deemed unsuitable for Tenant's continued use if, following a reasonable amount of reconstruction, Tenant's operations in the Premises Improvements could not be maintained at an economically feasible level. Subject to the rights of Leasehold Mortgagees and Tenant's Investors, if this Ground Lease terminates pursuant to this Section, Tenant shall surrender possession of the Premises and, subject to the rights of Leasehold Mortgagees and Tenant's Investors, assign to Landlord its rights and interests in and to the proceed of insurance received by Tenant for the repair or demolition of the Premises Improvements.

C. Loss Adjustment and Disbursement Procedures. Except as may otherwise be required by any Leasehold Mortgagee, Tenant shall make the loss adjustment with the insurance company insuring the loss. Except as may otherwise be required by any Leasehold

Mortgagee and Tenant's Investors, all resulting insurance proceeds shall be held for the following purposes:

1. The sums shall be paid in installments by the contractor retained by Tenant as construction progresses, for payment of the cost of restoration. Any final retention provided for in the contract with such contractor will be paid to the contractor on completion of restoration, payment of all costs, expiration of all applicable lien periods, and proof that the restored Improvements and the Premises are free of all mechanics' liens and lienable claims.

2. Payments shall be made on presentation of certificates or vouchers from the architect or engineer retained by Tenant showing the amount due. If Landlord, in its reasonable discretion, determines that the certificates or vouchers are being improperly approved by the architect or engineer retained by Tenant, Landlord shall have the right to appoint a project manager to supervise construction and to approve payments on certificates or vouchers approved by the architect or engineer retained by the Tenant. The reasonable expenses and charges of the project manager retained by Landlord shall be paid from the insurance proceeds.

3. If at any time it reasonably appears to Tenant that the sums held by the Tenant are not sufficient to pay the actual cost of restoration, Tenant shall identify the amount of the deficiency to Landlord as promptly thereafter as reasonably possible.

4. Any undisbursed funds after compliance with the provisions of this Section 10.1C shall be delivered to Landlord to the extent of Landlord's contribution to the fund, and the balance, if any, shall be paid to Tenant.

**10.2 Waiver.** The provisions of this ARTICLE 10 shall govern the rights of the parties in the event of any full or partial destruction of the Premises Improvements and any improvements thereon. Tenant hereby waives the provisions of Civil Code Section 1932(2) and Civil Code Section 1933(4) and any similar successor statute or Law with respect to any destruction of the Premises Improvements.

**10.3 Determination of Extent of Destruction, Interference with Use.** For purposes of this ARTICLE 10, the extent of destruction of the Premises Improvements shall be determined by dividing the estimated cost of replacement or restoration as evidenced by estimates prepared by licensed general contractors acceptable to Landlord for the full replacement cost of the Premises Improvements, as reasonably determined by Landlord, Tenant and (to the extent required by the applicable insurance policies) Tenant's insurers.

**10.4 Procedures for Repair and Restoration.** Tenant shall promptly give Landlord reasonable written notice in the event of any damage or destruction to either (i) the Premises Improvements or (ii) (to the extent of Tenant's actual knowledge) the entire Development, with an estimated restoration cost exceeding \$1,000,000 (subject to adjustment pursuant to the CPI from and after the Ground Lease Date). Tenant's notice shall include the general nature of the damage or destruction and the date on which it occurred. Regardless of the amount of any damage or destruction, Tenant shall promptly make proof of loss and shall proceed promptly to collect, or cause to be collected, all valid claims which Tenant may have against insurers or others based upon any such damage or destruction. Except as otherwise provided above and subject to rights of Leasehold Mortgagees and Investors, amounts received on account of any losses pursuant to insurance policies shall be used and expended for the purpose of fully repairing or reconstructing the portions of the Premises Improvements which

have been destroyed or damaged (or repaying loans or advances used for such purposes).. Tenant shall commence and complete or cause to be commenced and completed any repairs and reconstruction in a good and workmanlike manner and in accordance with the Site REA, this ARTICLE 10 and the applicable provisions of ARTICLE 5 above.

## ARTICLE 11. CONDEMNATION

### 11.1 Definitions.

A. **“Condemnation”** means: (1) the exercise of any governmental power in eminent domain, whether by legal proceedings or otherwise, by a condemnor, and (2) a voluntary sale or transfer to any condemnor, either under threat of condemnation or while legal proceedings for condemnation are pending.

B. **“Date of taking”** means the date the condemnor has the right to possession of the property being condemned.

C. **“Award”** means all compensation, sums or anything of value awarded, paid or received on a total or partial condemnation.

D. **“Condemnor”** means any public or quasi-public authority, or private corporation or individual, having the power of condemnation.

**11.2 Parties’ Rights and Obligations to be Governed by Ground Lease.** If during the Term there is any taking of all or any part of the Premises, the Premises Improvements or any other improvements on the Premises or any interest in this Ground Lease by condemnation, the rights and obligations of the parties shall be determined pursuant to the provisions of this ARTICLE 11.

**11.3 Total Taking.** If the Premises or Premises Improvements are totally taken by condemnation, this Ground Lease shall terminate on the date of taking.

**11.4 Effect of Partial Taking.** If a portion of the Premises Improvements or Premises or any other improvements thereon are taken by condemnation, this Ground Lease shall remain in effect, except that Tenant may elect to terminate this Ground Lease if the remaining portion of the Premises or Premises Improvements are rendered unsuitable (as defined herein) for Tenant’s continued use. The remaining portion of the Premises Improvements or the Premises shall be deemed unsuitable for Tenant’s continued use if, following a reasonable amount of reconstruction, Tenant’s operations in the Premises Improvements could not be maintained at an economically feasible level. Tenant must exercise its right to terminate by giving Landlord written notice of its election within 90 days after the nature and extent of the taking have been finally determined. Such notice shall also specify the date of termination, which shall not be prior to the date of taking. Failure to properly exercise the election provided for in this Section 11.4 will result in this Ground Lease continuing in full force and effect.

**11.5 Restoration of Premises Improvements.** If in Tenant’s judgment it is reasonably possible and economically feasible to do so, Tenant shall be entitled to use that portion of the award allocable to the Premises Improvements as is necessary to restore or to add on to the Premises Improvements so that the area and approximate layout of the Premises

Improvements will be substantially the same after the date of taking as it was before the date of taking. If it is not reasonably possible and economically feasible to so restore the area and layout of the Premises Improvements, the remaining provisions of this ARTICLE 11 shall govern the rights of the parties. If Tenant fails to promptly commence any reasonably required repair, restoration or reconstruction of the Premises Improvements and diligently prosecute such repair, restoration or reconstruction to completion, and such failure is not remedied within 30 days of written notice from the Landlord to Tenant, this Ground Lease may be terminated by the Landlord.

**11.6 Waiver of CCP Section 1265.130.** Each party waives the provisions of the Code of Civil Procedure Section 1265.130 allowing either party to petition the Superior Court of the County of Alameda, State of California to terminate this Ground Lease in the event of a partial taking of the Premises.

**11.7 Award.** Subject to the provisions of Section 11.5, and subject to the rights of Leasehold Mortgagees and Investors, if all or any portion of the Premises Improvements or any other improvements on the Premises is taken in connection with a condemnation, the award for the Premises Improvements or such other improvements shall be allocated taking into account that the Landlord's interest is limited to the land or air space (exclusive of the Premises Improvements). If the Premises Improvements are to be restored pursuant to Section 11.5 above, Tenant shall be entitled to recover the costs and expense incurred in such restoration out of any condemnation proceeds. Thereafter, if the condemning authority does not make separate awards, the proceeds will be allocated on a proportionate basis. If Landlord and Tenant are unable to agree as to the amounts that are to be allocated to each other, the allocation will be determined by an appraisal performed by a mutually agreed appraiser. The appraiser shall separately determine the amount of award to be allocated to the interest of each party, and the costs of the appraiser shall be borne equally by each party.

## **ARTICLE 12. ASSIGNMENT AND SUBLETTING**

### **12.1 Assignment.**

A. Tenant shall not assign, sublet or otherwise transfer, whether voluntarily or involuntarily or by operation of Law, this Ground Lease, the Premises Improvements or any part thereof (collectively an "**assignment**") without Landlord's written consent, which shall not unreasonably be withheld, conditioned or delayed. The merger of Tenant with any other entity or the assignment or transfer of any direct or indirect controlling or managing ownership interest in Tenant, or the assignment or transfer of a substantial portion of the assets of Tenant, whether or not located at the Premises, or any interest in the Premises Improvements, shall constitute an "assignment" hereunder. However, the transfer of a limited partnership interest in a limited partnership tenant, or of a non-managing membership interest in a limited liability company tenant, shall not constitute an assignment.

B. Notwithstanding Subsection 12.1A above, Landlord's consent is not required for any assignment to an Affiliate (as defined below) of BRIDGE, as long as the following conditions are met: (i) Landlord receives written notice of the assignment (as well as any documents or information reasonably requested by Landlord regarding the assignment or assignee); and (ii) the assignee assumes in writing all of Tenant's obligations under this Ground Lease. For purposes of this Section, "**Affiliate**" means an entity which controls, is controlled by or under common control with Tenant. For the purposes of this definition, "control" means the

direct or indirect ownership of more than 50% of the voting securities of an entity or possession of the right to direct the entity's day-to-day affairs.

C. Also notwithstanding Subsection 12.1A above, Landlord's consent is not required for any assignment to an Investor, as long as the following conditions are met: (i) the assignment occurs pursuant to the term of Tenant's governing documents, following a default to the Investor; (ii) Landlord receives written notice of the assignment (as well as any documents or information reasonably requested by Landlord regarding the assignment or assignee); and (iii) the Investor assumes in writing all of Tenant's obligations under this Ground Lease.

D. No partial assignments of this Ground Lease shall be permitted, and all assignments must be accompanied by a concurrent transfer of the Premises Improvements to the assignee. Assignments of this Ground Lease shall only be made pursuant to a written assignment and assumption agreement in a form reasonably acceptable to Landlord. Landlord's consent to any one assignment shall not constitute consent to any other assignment, and shall not constitute a waiver of the right to give or withhold consent in accordance with this Section 12.1.

E. In the event Tenant shall assign this Ground Lease or request the consent of Landlord to any assignment for which Landlord's consent is required under this ARTICLE 12, then Tenant shall pay Landlord's reasonable attorneys' fees incurred in connection with each such request.

**12.2 Subleases.** Except as to residential tenants and other tenants typically entered into in connection with residential development (such as laundry leases) and subject to all Regulatory Requirements, Tenant shall not sublease all or any portion of the Premises Improvements or the Premises without Landlord's prior written consent, which may be withheld for any reason whatsoever in Landlord's sole absolute discretion. No permitted subletting shall limit Tenant's obligations under this Lease.

## **ARTICLE 13. TENANT DEFAULTS AND LANDLORD'S REMEDIES**

**13.1 Defaults by Tenant.** Tenant shall be in default under this Ground Lease upon occurrence of any of the following:

A. Tenant shall at any time be in default in the payment of Rent or any other monetary sum called for by this Ground Lease for more than 30 days following written notice from Landlord to Tenant; or

B. Tenant shall at any time be in default in the keeping and performing any of its covenants or agreements contained in the Regulatory Requirements or Site REA, and such other default continues for 30 days after written notice thereof from Landlord to Tenant specifying the particulars of such default, or if such default is of a nature that curing such default will take more than 30 days Tenant has failed to commence such cure within such 30-day period and to thereafter diligently and continuously pursue completion of such cure, provided that such cure period need not exceed any time period that the failure to cure would result in Landlord itself being in violation of any Law or expose Landlord to unreasonable financial risks; or

C. Tenant shall at any time be in default in the keeping and performing of any of its other covenants or agreements contained in this Ground Lease, and should such other

default continue for 30 days after written notice thereof from Landlord to Tenant specifying the particulars of such default, or if such other default is of a nature that curing such default will take more than 30 days Tenant has failed to commence such cure within such 30-day period and to thereafter diligently and continuously pursue completion of such cure; or

D. Tenant abandons or substantially suspends the Premises Improvements prior to completion thereof and such default is not cured within 60 days of written notice from Landlord to Tenant; or

E. Tenant assigns, sells, transfers, conveys, encumbers, hypothecates or leases the whole or any part of the Premises Improvements, the Premises, or any other improvement constructed thereon in violation of the Improvements Documents; or

F. Except as otherwise expressly permitted in this Ground Lease there is any change in control of Tenant, or any other act or transaction involving or resulting in a change in the identity of the parties in control of Tenant or the degree of such control; or

G. Subject to ARTICLE 14 below, Tenant defaults on any loan encumbering Tenant's interest in this Ground Lease or any improvements on the Premises for which Tenant is responsible, and such failure continues beyond (i) the expiration of any applicable grace or cure period, and (ii) the date by which Tenant must make payment to cure any notice of default received from the holder of such loan; or

H. Any Leasehold Mortgagee or any other holder of any private loan encumbering Tenant's interest in this Ground Lease, or any improvements on the Premises initiates a foreclosure of the deed of trust by which such loan is secured, and Tenant fails to cause such foreclosure proceedings to be dismissed prior to the earlier to occur of (i) the trustee under the deed of trust giving notice of the trustee's sale, or (ii) within 30 days of Tenant's receipt of written notice from Landlord.

**13.2 Remedies.** Subject to the rights of any Leasehold Mortgagees permitted under ARTICLE 14, upon the occurrence of any such default, in addition to any and all other rights or remedies of Landlord hereunder, or by Law or in equity provided, Landlord shall have the sole option to exercise the following rights and remedies:

A. Terminate this Ground Lease by giving Tenant notice of termination. On the giving of such notice, all of Tenant's rights in the Premises, Premises Improvements and any other improvements located thereon, shall terminate. Immediately following notice of termination, Tenant shall surrender and vacate the Premises, including the Premises Improvements and any other improvements located thereon, leaving them in broom-clean condition; and, subject to Subsection 13.2B below, respecting the right of certain subtenants to remain, Landlord may reenter and take possession of the Premises and Premises Improvements and eject all parties in possession or eject some and not others, or eject none. Termination under this subsection shall not relieve Tenant from the payment of any sum then due to Landlord or from any claim for damages previously accrued or then accruing against Tenant.

B. Without terminating this Ground Lease, Landlord may at any time and from time to time relet the Premises, including the Premises Improvements, or any part or parts thereof for the account and in the name of Tenant or otherwise. Any reletting may be for the remainder of the Term or for a longer or shorter period, and subject to the rights of any subtenant under subleases permitted under Section 12.2. Landlord may execute any leases made under

this provision either in Landlord's name or in Tenant's name, and shall be entitled to all rents from the use, operation, and occupancy of the Premises, Premises Improvements and any other improvements thereon. Tenant hereby appoints Landlord its attorney-in-fact for purpose of such leasing. Tenant shall nevertheless pay to Landlord on the due dates specified in this Ground Lease the equivalent of all sums required of Tenant under this Ground Lease, less the revenue received by Landlord from any reletting or attornment, plus Landlord's reasonable expenses, including (by way of example), but not limited to, remodeling expenses, Landlord's brokerage and advertising costs and attorneys' fees and costs. No act by or on behalf of Landlord under this subsection shall constitute a termination of this Ground Lease unless Landlord gives Tenant written notice of termination, and Tenant shall remain liable for all costs, losses and damages resulting from unperformed Tenant obligations and breaches under permitted subleases.

C. Even though Landlord may have relet all or any portion of the Premises, including the Premises Improvements and any other improvements thereon, Landlord may thereafter elect to terminate this Ground Lease and all of Tenant's rights in or to the foregoing.

**13.3 Damages.** Neither party shall be entitled to recover consequential or punitive damages under this Lease.

**13.4 Landlord's Right to Cure Tenant's Default.** Landlord, at any time after Tenant commits a default which Tenant has failed to cure within the time established therefor, may cure the default at Tenant's cost. If Landlord at any time, by reason of Tenant's default, pays any sum, the sum paid by Landlord shall be due immediately from Tenant to Landlord at the time the sum is paid, and if paid at a later date, shall bear interest at the Interest Rate from the date the sum is paid by Landlord until Landlord is reimbursed by Tenant. The sum, together with interest thereon, shall be Additional Rent.

**13.5 Guarantor Performance Under Completion Guaranty.** Notwithstanding anything in this Ground Lease to the contrary (other than the last sentence of this Section 13.5), (i) if Landlord enforces its rights against Guarantor, Guarantor's performance in compliance with the Completion Guaranty shall be deemed to suspend any default by Tenant under this Ground Lease relating to the construction of the Premises Improvements, and Landlord shall accept Guarantor's performance thereof; and (ii) so long as the Guarantor proceeds diligently to perform the guaranteed obligations thereunder (subject to permitted force majeure delays and other delays expressly specified in the Completion Guaranty) and to cause the Premises Improvements to be completed within three years following the date completion is otherwise required under this Ground Lease, Landlord shall not exercise any of its remedies under the Ground Lease arising from the Tenant's failure to construct the Premises Improvements as required herein including, without limitation, termination of this Ground Lease. Nothing in this Section 13.5 shall limit Landlord's right to collect any amounts otherwise due under Section 13.4 following Guarantor's satisfaction of all obligations under the Completion Guaranty or Guarantor's default thereunder.

## **ARTICLE 14. MORTGAGEE PROTECTION PROVISIONS**

**14.1 Right to Encumber.** Tenant shall have the right during the Term to encumber, through one or more Leasehold Mortgages and the Regulatory Requirements, all of Tenant's right, title and interest in the Premises, subject to the provisions of this Ground Lease; provided, however, that any Leasehold Mortgage shall be in all respects subordinate and inferior to Landlord's right, title and interest as fee title owner of the Site and Premises, and any

such Leasehold Mortgagee shall be subject to all of the rights and obligations of Landlord herein contained in this Ground Lease, except as otherwise provided in this Ground Lease. For purposes of this Ground Lease, Landlord and Tenant acknowledge and agree that the Senior Leasehold Mortgagee identified on **Exhibit F** attached hereto is a permitted Leasehold Mortgagee and all references to a "Leasehold Mortgagee" shall specifically include Senior Leasehold Mortgagee. All references to a Leasehold Mortgage shall include, without limitation, that certain Construction Leasehold Deed of Trust, Security Agreement, Assignment of Leases and Rents and Fixture Filing, dated as of even date herewith, made by Tenant for the benefit of the initial Senior Leasehold Mortgagee. For so long as any Leasehold Mortgage is outstanding, Landlord shall not agree to any mutual termination or accept any surrender of this Ground Lease without the prior written consent of the holders of Leasehold Mortgages then in effect, and any such termination or surrender without such consent shall have no force or effect.

**14.2 Leasehold Mortgagee as Third Party Beneficiary.** Notwithstanding anything to the contrary contained herein, a Leasehold Mortgagee shall be deemed to be a third party beneficiary of Tenant's obligations under this Ground Lease; provided that the foregoing shall not alter any right, remedy, duty or obligation between Tenant and Landlord herein.

**14.3 Notice to Leasehold Mortgagee.** During any period in which a Leasehold Mortgage is in place, Landlord shall give any such Leasehold Mortgagee of which Landlord has received notice from Tenant a duplicate copy of all notices of default or other notices that Landlord may give to or serve in writing upon Tenant pursuant to the terms of this Ground Lease. The address of the Leasehold Mortgagee originally designated in the Leasehold Mortgage may be changed upon written notice delivered to Landlord in the manner specified in Section 15.5 below. Landlord's failure to give any such notice to any such Leasehold Mortgagee shall not render such notice ineffective, nor shall any such failure constitute a default hereunder. Landlord acknowledges the Leasehold Mortgagee identified in **Exhibit F** as a holder of a Leasehold Mortgage.

**14.4 Right of Leasehold Mortgagee to Cure.** Notwithstanding any default by Tenant under this Ground Lease, Landlord shall have no right to terminate this Ground Lease unless Landlord shall have given each Leasehold Mortgagee written notice of such default and such Leasehold Mortgagees shall have failed to remedy such default or acquire Tenant's leasehold estate created by this Ground Lease or commence foreclosure or other appropriate proceedings as set forth in, and within the time specified by, this Section 14.4.

A. Any Leasehold Mortgagee which has an outstanding Leasehold Mortgage shall have the right, but not the obligation, at any time to pay any or all of the Rent due pursuant to the terms of this Ground Lease, and do any other act or thing required of Tenant by the terms of this Ground Lease, to prevent termination of this Ground Lease. Each Leasehold Mortgagee shall have 90 days after receipt of notice from Landlord describing such default to cure the default. All payments so made and all things so done shall be as effective to prevent a termination of this Ground Lease as the same would have been if made and performed by Tenant instead of by Leasehold Mortgagees.

B. In addition to the cure period provided in Section 14.4A above, if the default is such that possession of the Premises may be reasonably necessary to remedy the default, any Leasehold Mortgagee shall have a reasonable time after the expiration of such 90 day period within which to remedy such default, provided that (i) such Leasehold Mortgagee shall have fully cured any default in the payment of any monetary obligations of Tenant under this Ground Lease within such 90 day period and shall continue to pay currently such monetary



obligations when the same are due and (ii) such Leasehold Mortgagee shall have acquired Tenant's leasehold estate hereunder or commenced foreclosure or other appropriate proceedings prior to or within such period, and shall be diligently prosecuting the same.

C. Any default under this Ground Lease which by its nature cannot be remedied by any Leasehold Mortgagee shall be deemed to be remedied if (i) within 90 days after receiving written notice from Landlord describing the default, or prior thereto, any Leasehold Mortgagee shall have acquired Tenant's leasehold estate or commenced foreclosure or other appropriate proceedings, (ii) Leasehold Mortgagee shall diligently prosecute any such proceedings to completion, (iii) Leasehold Mortgagee shall have fully cured any default in the payment of any monetary obligations of Tenant hereunder which does not require possession of the Premises, and (iv) after gaining possession of the Premises, the Leasehold Mortgagee shall cure all non-monetary defaults of Tenant hereunder capable of cure by Leasehold Mortgagee.

D. If any Leasehold Mortgagee is prohibited, stayed or enjoined by any bankruptcy, insolvency or other judicial proceedings involving Tenant from commencing or prosecuting foreclosure or other appropriate proceedings, the times specified for commencing or prosecuting such foreclosure or other proceedings shall be extended for the period of such prohibition; provided that any Leasehold Mortgagee shall have fully cured any default in the payment of any monetary obligations of Tenant under this Ground Lease and shall continue to pay currently such monetary obligations when the same fall due; provided, further, that such Leasehold Mortgagee shall not interfere with Landlord's efforts to seek compliance by the Tenant with any non-monetary obligation under this Ground Lease.

E. As used in this Section 14.4, "monetary obligations of Tenant" does not include damages, costs and expenses arising from any obligation of Tenant to indemnify Landlord for any acts or omission of Tenant prior to the date a Leasehold Mortgagee assumes the obligations of Tenant hereunder.

**14.5 Limitation on Liability of Leasehold Mortgagee.** No Leasehold Mortgagee shall be or become liable to Landlord as an assignee of this Ground Lease or otherwise unless it expressly assumes by written instrument executed by Landlord and Leasehold Mortgagee such liability (in which event the Leasehold Mortgagee's liability shall be limited to the period of time during which it is the owner of the leasehold estate created hereby) and no assumption shall be inferred from or result from foreclosure or other appropriate proceedings in the nature thereof or as the result of any other action or remedy provided for by such Leasehold Mortgagee or other instrument or from a conveyance from Tenant pursuant to which the purchaser at foreclosure or grantee shall acquire the rights and interest of Tenant under the terms of this Ground Lease.

**14.6 Estoppel Certificates.** Landlord and Tenant agree that at any time and from time to time upon not less than 20 days' prior written notice by the other party, or upon request from any Leasehold Mortgagee or Investor or a permitted assignee, Landlord or Tenant will execute and deliver to the other party or to such Leasehold Mortgagee or Investor a statement in writing certifying (a) that this Ground Lease is unmodified and in full force and effect (or specifying any known amendments if applicable); (b) the date through which the Rents have been paid; and (c) that, to the knowledge of the certifier (if such be the case), there is no default (or any conditions existing which, but for the passage of time or the giving of notice, would constitute a default) set off, defense or other claim against Landlord or Tenant, as applicable, other than those, if any, so specified under the provisions of this Ground Lease. It is intended that any such statement may be relied upon by any persons proposing to acquire the

interest of Landlord, Tenant or any Leasehold Mortgagee or Investor, as the case may be, in this Ground Lease or by any prospective Leasehold Mortgagee or Investor or permitted assignee of any Leasehold Mortgage or Investor.

**14.7 Registration of Leasehold Mortgages.** Upon written request by Landlord, Tenant shall provide written notice to Landlord of the name and address of each Leasehold Mortgagee under this Ground Lease.

**14.8 New Ground Lease.** In the event of the termination of this Ground Lease prior to the natural expiration of the Term of this Ground Lease due to a default of Tenant or operation of law or otherwise (including, without limitation, a rejection or other termination of this Ground Lease pursuant to any bankruptcy filing by or against Tenant or the commencement of any other insolvency proceeding or similar proceeding, an act of condemnation or eminent domain against a portion of the Premises by a government agency or body, the destruction or damage of the Premises, or upon a foreclosure of Tenant's estate by a Leasehold Mortgagee or acceptance of a deed in lieu of foreclosure or a change in the control or management of Tenant in violation of this Ground Lease), Landlord shall also be obligated to give notice to Leasehold Mortgagee simultaneously under Section 14.3 hereof with such notice given to Tenant; provided that no failure to give such notice to Leasehold Mortgagee shall invalidate the termination of this Ground Lease. Landlord, upon written request from Senior Leasehold Mortgagee and at Senior Mortgagee's sole cost and expense, shall enter into a new lease with such holder or its designee in accordance with and upon the same terms and conditions as set forth in this Ground Lease. In addition, without limiting the preceding sentences, in the event of the filing of a petition in bankruptcy by or against Tenant, and the Tenant rejects this Ground Lease under the then applicable provisions of the Bankruptcy Code, Landlord shall, upon the request of a Leasehold Mortgagee and at Senior Leasehold Mortgagee or its designee's sole cost and expense, affirm this Ground Lease, and Landlord will enter into a new ground lease on the same terms and conditions set forth in this Ground Lease with such holder or its designee promptly upon Tenant's rejection of this Ground Lease. In the event of the filing of a petition in bankruptcy by the Landlord, and the Landlord rejects this Ground Lease and the Tenant does not affirm it, a Leasehold Mortgagee will have the authority to affirm this Ground Lease on behalf of the Tenant and to keep the Ground Lease in full force and effect.

A. After cancellation and termination of this Ground Lease, and upon compliance with the provisions of this Section 14.8 by Leasehold Mortgagee, or its designee, upon the request of Leasehold Mortgagee or its designee within the time provided in Section 14.4 hereof, Landlord shall, at Senior Leasehold Mortgagee or its designee's sole cost and expense, execute and deliver such new ground lease to such Leasehold Mortgagee or its designee, having the same relative priority in time and right as this Ground Lease (to the extent possible) and having the benefit of all the right, title, interest, powers and privileges, and obligations and liabilities of Tenant hereunder in and to the Premises.

**14.9 Rights of Investor.** The Investor shall have the same notice and cure rights as any Leasehold Mortgagee (including monetary obligations) as set forth in Section 14.4 for so long as it is a limited partner of Tenant; provided, however, that Investor shall be deemed to have met any condition relating to commencement or continuation of a foreclosure proceeding as set forth in Section 14.4 above, if it is attempting with diligence and in good faith to remove the general partner of Tenant. The address for any notices to Investor, as of the date hereof, is provided in Basic Lease Information Section 14.

**14.10 Transfers.** The consent of Landlord shall not be required for the mortgage of Tenant's interest in the Premises and Premises Improvements to any Leasehold Mortgagee, including, without limitation, Senior Leasehold Mortgagee, and transfer of the Premises and Premises Improvements to such Leasehold Mortgagee by foreclosure or deed-in-lieu of foreclosure (or the leasehold equivalent thereof), or to a third-party purchaser pursuant to a foreclosure sale (or the leasehold equivalent thereof); the consent of Landlord to a Transfer by a Leasehold Mortgagee after acquisition by foreclosure, at Senior Leasehold Mortgagee or its designee's sole cost and expense, will not be unreasonably withheld or delayed.

**14.11 [Intentionally Omitted]**

**14.12 Further Ground Lease Amendments.** Landlord shall cooperate in including in this Ground Lease by suitable amendment from time to time any provision which may reasonably be requested by any Leasehold Mortgagee or any proposed lender, at Leasehold Mortgagee or proposed lender's sole cost and expense, for the purpose of implementing the mortgagee-protection provisions contained in this Ground Lease and allowing such Leasehold Mortgagee or proposed lender reasonable means to protect or preserve the lien of the leasehold mortgage and the value of its security, and to include any additional rights and privileges reasonably requested to be added by such Leasehold Mortgagee. Landlord agrees to execute and deliver (and to acknowledge, if necessary, for recording purposes) any agreement necessary to effect any such amendment; provided, however, that any such amendment shall not in any way affect Landlord's fee estate in the Site or any other interest of Landlord in the Site or Premises, affect the Term or rent under this Ground Lease, or otherwise in any material respect adversely affect any rights of Landlord under this Ground Lease or (except as otherwise expressly provided herein) Regulatory Requirements.

**ARTICLE 15.  
MISCELLANEOUS**

**15.1 Holding Over.** If Tenant shall hold over in the Premises Improvements or Premises after the expiration or termination of the Term hereof with or without the consent of Landlord, such holding over shall be construed to be only a tenancy from month to month, subject to all the covenants, conditions and obligations contained in this Ground Lease. Tenant hereby agrees to pay to Landlord as monthly rental \$500 per month, plus all Additional Rent as otherwise required in this Ground Lease.

**15.2 Attorneys' Fees.** In the event that any action is brought by either party hereto against the other for the enforcement or declaration of any right or remedy in or under this Ground Lease or for the breach of any covenant or condition of this Ground Lease, the prevailing party shall be entitled to recover, and the other party agrees to pay, all fees and costs to be fixed by the court therein including, but not limited to, attorneys' fees.

**15.3 Quiet Possession.** Landlord agrees that so long as Tenant is not in default under this Ground Lease and is paying the Rent and performing all of the covenants and conditions of this Ground Lease, Tenant shall quietly have, hold and enjoy the Premises throughout the Term hereof without interruption or disturbance from Landlord or any other persons claiming by, through or under Landlord. For purposes of this Section 15.3, persons exercising their rights under the Site REA shall be deemed to a person claiming by, through or under Tenant.

**15.4 Force Majeure.** Except as to the payment of Rent, subject to the limitations set forth below, performance by either party hereunder (including without limitation continuing obligations under the DDA) shall not be deemed to be in default, and all performance and other dates specified in this Ground Lease shall be extended, where delays are due to: war; insurrection; strikes; lockouts; riots; floods; earthquakes; fires; casualties; acts of God; acts of the public enemy; epidemics; quarantine restrictions; freight embargoes; governmental restrictions or priority; unusually severe weather; lack of reasonable availability of labor or materials; acts or omissions of the other party; or acts or failures to act of the City or any other public or governmental agency or entity (other than the acts or failures to act of Landlord which shall not excuse performance by Landlord) (together, "**Force Majeure**"). An extension of time for any such cause shall be for the period of the enforced delay and shall commence to run from the time of the commencement of the cause, if notice by the party claiming such extension is sent to the other party with reasonable promptness (not more than 30 days) of the commencement of the cause. Times of performance under this Ground Lease may also be extended in writing by the mutual agreement of Landlord and Tenant. Tenant expressly agrees that post-Ground Lease Date adverse changes in economic conditions, either of Tenant specifically or the economy generally, changes in market conditions or demand, and/or Tenant's inability to obtain financing or other lack of funding, shall not constitute a Force Majeure delay pursuant to this Section 15.4. Tenant expressly assumes the risk of such adverse economic or market changes and/or financial inability, whether or not foreseeable as of the Ground Lease Date.

**15.5 Notices.** Any notice to be given or other document to be delivered by either party to the other hereunder shall be in writing and shall be deemed to have been duly given and received (i) upon personal delivery, (ii) as of the third business day after mailing by United States registered or certified mail, return receipt requested, postage prepaid, addressed as set forth below, or (iii) the immediately succeeding business day after deposit with Federal Express or other equivalent overnight delivery system, addressed to the party for whom intended, as indicated in the Basic Ground Lease Information. Any party hereto may from time to time, by written notice to the other, designate a different address which shall be substituted for the one above specified.

**15.6 Waiver.** No waiver of any breach of any of the terms, covenants, agreements, restrictions or conditions of this Ground Lease shall be construed to be a waiver of any succeeding breach of the same or other terms, covenants, agreements, restrictions and conditions hereof.

**15.7 Surrender.** Upon the expiration or sooner termination of the Term of this Ground Lease, and notwithstanding anything herein contained to the contrary, Tenant shall surrender to Landlord the Premises Improvements, the Premises and any other improvements thereon, broom clean and in good condition and repair, reasonable wear and tear excepted.

**15.8 Binding.** Subject to the restrictions set forth herein regarding assignment of , Tenant's interest in this Ground Lease, each of the terms, covenants and conditions of this Ground Lease shall extend to and be binding on and shall inure to the benefit of not only Landlord and Tenant, but to each of their respective heirs, administrators, executors, successors and assigns. Whenever in this Ground Lease reference is made to either Landlord or Tenant, the reference shall be deemed to include, wherever applicable, the heirs, administrators, executors, successors and assigns of such parties, the same as if in every case expressed.

**15.9 Disclaimer of Partnership.** The relationship of the parties hereto is that of Landlord and Tenant, and it is expressly understood and agreed that Landlord does not in any way nor for any purpose become a partner of Tenant or a joint venturer with Tenant in the Premises Improvements or in the conduct of Tenant's business or operations or otherwise.

**15.10 Quitclaim.** At termination or expiration of the Term of this Ground Lease, Tenant shall execute, acknowledge and deliver to Landlord within 30 days, a valid and recordable quitclaim deed covering the Premises and Premises Improvements, free and clear of all monetary liens and encumbrances not caused or agreed to by Landlord ("**Quitclaim Deed**"). If Tenant fails to clear all monetary liens and encumbrances as required by this Section at termination or expiration of the Term of this Ground Lease, Tenant shall continue to be liable and responsible for all such costs, liabilities and expenses associated with, related to or caused by such encumbrances that were not removed by Tenant, and Landlord may take any and all action to enforce its rights under this Ground Lease and to have such encumbrances removed, and all costs and expenses associated with such actions shall be paid solely by Tenant upon Landlord's demand

**15.11 Interpretation.** The titles to the sections of this Ground Lease are not a part of this Ground Lease and shall have no effect upon the construction or interpretation of any part of this Ground Lease. As used in this Agreement, masculine, feminine or neuter gender and the singular or plural number shall each be deemed to include the others where and when the context so dictates. The word "including" shall be construed as if followed by the words "without limitation." This Ground Lease shall be interpreted as though prepared jointly by both parties.

**15.12 Severability.** If any term, provision, condition or covenant of this Ground Lease or its application to any party or circumstances shall be held, to any extent, invalid or unenforceable, the remainder of this Ground Lease, or the application of the term, provision, condition or covenant to persons or circumstances other than those as to whom or which it is held invalid or unenforceable, shall not be affected, and shall be valid and enforceable to the fullest extent permitted by Law.

**15.13 Computation of Time.** The time in which any act is to be done under this Ground Lease is computed by excluding the first day, and including the last day, unless the last day is a holiday or Saturday or Sunday, and then that day is also excluded. The term "holiday" shall mean all holidays as specified in Sections 6700 and 6701 of the California Government Code. If any act is to be done by a particular time during a day, that time shall be Pacific Time Zone time.

**15.14 Legal Advice.** Each party represents and warrants to the other the following: they have carefully read this Ground Lease, and in signing this Ground Lease, they do so with full knowledge of any right which they may have; they have received independent legal advice from their respective legal counsel as to the matters set forth in this Ground Lease, or have knowingly chosen not to consult legal counsel as to the matters set forth in this Ground Lease; and, they have freely signed this Ground Lease without any reliance upon any agreement, promise, statement or representation by or on behalf of the other party, or their respective agents, employees, or attorneys, except as specifically set forth in this Ground Lease, and without duress or coercion, whether economic or otherwise.

**15.15 Time of Essence.** Time is expressly made of the essence with respect to the performance by Landlord and Tenant of each and every obligation and condition of this Ground Lease.

**15.16 Nonliability of Officials, Employees, etc.** No member, official or employee of Landlord shall be personally liable to Tenant, or any successor in interest, in the event of any default or breach by Landlord or for any amount which may become due to Tenant or its successors, or on any obligations under the terms of this Ground Lease. Tenant hereby waives and releases any claim it may have against the members, officials or employees of Landlord with respect to any default or breach by Landlord or for any amount which may become due to Tenant or its successors, or on any obligations under the terms of this Ground Lease. No member, partner (other than general partners as otherwise permitted by law), or board member, officer or employee of Tenant (or of any of Tenant's members or partners) shall be personally liable to Landlord, or any successor in interest, in the event of any default or breach by Tenant or for any amount which may become due to Landlord or its successors, or on any obligations under the terms of this Ground Lease. Landlord hereby waives and releases any claim it may have against Tenant's members, partners (other than general partners as otherwise permitted by law), or board members, officers or employees (or of any of Tenant's members or partners) with respect to any default or breach by Tenant or for any amount which may become due to Landlord or its successors, or on any obligations under the terms of this Ground Lease.

**15.17 Assignment by Landlord.** Landlord may assign or transfer any of its interests hereunder at any time without Tenant's consent. Any such assignment or transfer shall be in compliance with all Laws, and the assignee or transferee shall affirmatively assume all Landlord obligations hereunder.

**15.18 Applicable Law.** The laws of the State of California, including all statutes of limitations but without regard to conflict of laws principles, shall govern the interpretation and enforcement of this Ground Lease.

**15.19 Covenants and Conditions.** Each obligation of the parties hereunder, including, without limitation, Tenant's obligation for the payment of Rent, shall be construed to be both a covenant and a condition of this Ground Lease.

**15.20 Integration.** This Ground Lease, together with all exhibits and attachments hereto, the Site REA, and Regulatory Requirements (collectively, "**Improvements Documents**"), excluding the City Financing Documents, constitute the entire agreement between the parties relating to the Premises and there are no conditions, representations or agreements regarding the matters covered by this Ground Lease which are not expressed herein or in the Improvements Documents. Without limiting the foregoing, except as expressly provided in this Ground Lease (including without limitation **Exhibit C**), this Ground Lease supersedes the DDA. Notwithstanding the foregoing, nothing herein will limit or restrict the rights of any party under the Improvements Documents and City Financing Documents.

**15.21 Amendments to this Ground Lease.** Landlord and Tenant agree to mutually consider reasonable requests for amendments to this Ground Lease that may be made by either of them, lending institutions or bond counsel or financial consultants to Landlord or Tenant, provided such requests are consistent with this Ground Lease and would not materially alter the basic business terms herein or the other Improvements Documents. No amendment shall be effective unless in writing and signed by the parties hereto.

**15.22 Proprietary and Governmental Roles: Actions by City.** Except where clearly and expressly provided otherwise in this Ground Lease, the capacity of the City in this Ground Lease shall be as owner and lessor of property only ("**Proprietary Capacity**"), and any obligations or restrictions imposed by this Ground Lease on the City shall be limited to that capacity and shall not relate to, constitute a waiver of, supersede or otherwise limit or affect its governmental capacities, including enacting laws, inspecting structures, reviewing and issuing permits, and all of the other legislative and administrative or enforcement functions pursuant to federal, state or local law ("**Governmental Capacity**"). When acting in its Proprietary Capacity, discretionary actions may be undertaken by the City Manager or other designees as designated by the City Manager to the extent otherwise provided herein. In addition, nothing in this Ground Lease shall supersede or waive any discretionary or regulatory approvals required to be obtained from the City under applicable Law.

**15.23 City Manager Authority and Limitations.** Any amendment to this Ground Lease which affects or relates to: (i) the Term of this Ground Lease; (ii) the permitted use of the Premises and Premises Improvements; (iii) Rent amounts and other monetary payments by Tenant; or (iii) any other material provision of this Ground Lease, shall require approval by the Landlord's City Council. Subject to the foregoing, the City Manager may also issue without City Council approval any consent or approval which Landlord is entitled to provide under this Ground Lease, including without limitation: (w) Material Alterations under Section 5.6 above; (x) assignments under Section 12.1; (y) sublettings under Section 12.2; and (z) rules for a CASp inspection under Section 15.29.

**15.24 Brokerage Commissions.** Landlord and Tenant each represents that it has not been represented by any broker in connection with this Ground Lease, and that no real estate broker's commission, finder's fee or other compensation (individually and collectively, "**Brokerage Commission**") is due or payable. Landlord and Tenant each agrees to indemnify and hold the other harmless from any claims or liability, including reasonable attorneys' fees, in connection with a claim by any person for a Brokerage Commission based upon any statement, representation or agreement of the other party.

**15.25 City Non-Discrimination Ordinance.** Tenant hereby agrees to comply with the provisions of the Berkeley Municipal Code ("**B.M.C.**"), including without limitation Chapter 13.26, as amended from time to time. In the performance of its obligations under this Ground Lease, Tenant agrees as follows:

A. Tenant shall not discriminate against any employee or applicant for employment because of race, color, religion, ancestry, national origin, age (over 40), sex, pregnancy, marital status, disability, sexual orientation or AIDS.

B. Tenant shall permit Landlord access to records of employment, employment advertisements, application forms, EEO-1 forms, affirmative action plans and any other documents which, in the reasonable opinion of Landlord, are necessary to monitor compliance with this non-discrimination provision. In addition, Tenant shall fill out, in a timely fashion, forms supplied by Landlord to monitor this non-discrimination provision.

**15.26 Non-Discrimination Against Persons With Disabilities.**

A. If Tenant provides any aid, service or benefit to others on the Landlord's behalf, Tenant shall, in the provision of such aid, service or benefit, observe and comply with all applicable provisions of Title II of the Americans with Disabilities Act of 1990 and any amendments thereto. Tenant shall further observe and comply with all applicable federal, state, municipal and local laws, ordinances, codes and regulations prohibiting discrimination against individuals with disabilities or ensuring that individuals with disabilities are not excluded from participating in or receiving benefits, services or activities of the Landlord, if applicable.

B. If Tenant is or becomes a "public accommodation" as defined in Title III of the Americans with Disabilities Act of 1990, Tenant shall observe and comply with all applicable provisions of the Act and any amendments thereto, and all applicable federal, state, municipal and local laws, ordinances, codes and regulations prohibiting discrimination on the basis of disability in the full and equal enjoyment of goods, services, facilities, privileges, advantages, or accommodations offered by the Tenant. All of Tenant's activities must be in accordance with these laws, ordinances, codes, and regulations, and Tenant shall be solely responsible for complying therewith.

**15.27 Conflict of Interest Prohibited.**

A. In accordance with California Government Code Section 1090, Berkeley City Charter Section 36 and B.M.C. Chapter 3.64, neither Tenant nor any employee, officer, director, partner or member of Tenant, or immediate family member of any of the preceding, shall have served as an elected officer, an employee, or a committee or commission member of Landlord, who has directly or indirectly influenced the making of this Ground Lease.

B. In accordance with California Government Code Section 1090 and the Political Reform Act, (Government Code Section 87100 et seq.,) no person who is a director, officer, partner, trustee, employee or consultant of Tenant, or immediate family member of any of the preceding, shall make or participate in a decision made by Landlord or any of its boards, commissions or committees, if it is reasonable foreseeable that the decision will have a material effect on any source of income, investment or interest in real property of that person or Tenant, except to the extent permitted by 2 California Code of Regulations, Section 18700(c)(2).

C. Interpretation of this paragraph shall be governed by the definitions and provisions use in the Political Reform Act, Government Code section 87100 et seq., its implementing regulations, manuals and codes, Government Code section 1090, Berkeley City Charter section 36 and B.M.C. Chapter 3.64, as amended from time to time.

**15.28 Nuclear Free Berkeley.** Tenant agrees to comply with B.M.C. Chapter 12.90, the Nuclear Free Berkeley Act, as amended from time to time.

**15.29 Required Accessibility Disclosure.**

A. Landlord hereby advises Tenant that the Premises and Premises Improvements have not undergone an inspection by a certified access specialist, and except to the extent expressly set forth in this Ground Lease, Landlord shall have no liability or responsibility to make any repairs or modifications to the Premises or the Premises Improvements in order to comply with accessibility standards. The following disclosure is hereby made pursuant to applicable California law:



B. "A Certified Access Specialist (CASp) can inspect the subject premises and determine whether the subject premises comply with all of the applicable construction-related accessibility standards under state law. Although state law does not require a CASp inspection of the subject premises, the commercial property owner or lessor may not prohibit the lessee or tenant from obtaining a CASp inspection of the subject premises for the occupancy or potential occupancy of the lessee or tenant, if requested by the lessee or tenant. The parties shall mutually agree on the arrangements for the time and manner of the CASp inspection, the payment of the fee for the CASp inspection, and the cost of making any repairs necessary to correct violations of construction-related accessibility standards within the premises." [Cal. Civ. Code Section 1938(e)]. Any CASp inspection shall be conducted in compliance with reasonable rules in effect at the Premises with regard to such inspections and shall be subject to Landlord's prior written consent.

**15.30 Oppressive States.**

A. In accordance with Resolution No. 59,853-N.S., Tenant certifies that it has no contractual relations with, and agrees during the Term of this Ground Lease to forego contractual relations to provide personal services to, the following entities:

1. The governing regime in any Oppressive State.
2. Any business or corporation organized under the authority of the governing regime of any Oppressive State.
3. Any individual, firm, partnership, corporation, association, or any other commercial organization, and including parent-entities and wholly-owned subsidiaries (to the extent that their operations are related to the purpose of this Ground Lease) for the express purpose of assisting in business operations or trading with any public or private entity located in any Oppressive State.

B. For purposes of this Ground Lease, the Tibet Autonomous Region and the provinces of Abo, Kham, and U-Tsang shall be deemed oppressive states.

C. Tenant's failure to comply with this Section shall constitute a default of this Ground Lease and Landlord may terminate this Ground Lease pursuant to ARTICLE 13. In the event that Landlord terminates this Ground Lease due to a default under this provision, Landlord may deem Tenant a non-responsible bidder for five years from the date this Ground Lease is terminated.

**15.31 Berkeley Living Wage Ordinance (LWO).**

A. Tenant agrees to comply with Berkeley Municipal Code Chapter 13.27, the Berkeley Living Wage Ordinance. If Tenant employs six or more part-time or full-time employees, and generates \$350,000 or more in annual gross receipts, Tenant will be required to provide all eligible employees with City mandated minimum compensation during the Term of this Ground Lease, as defined in B.M.C. Chapter 13.27, and well as comply with the terms enumerated herein.

B. Tenant shall be required to maintain all reasonable records and documents that would establish whether Tenant is subject to Berkeley's Living Wage Ordinance ("LWO"). If Tenant is subject to the LWO, as defined therein, Tenant shall be further required to

maintain monthly records of those employees located on the leased Premises. These records shall include the total number of hours worked, the number of hours spent providing service on the leased Premises, the hourly rate paid, and the amount paid by Tenant for health benefits, if any, for each of its employees providing services under the lease. The records described in this Section shall be made available upon the Landlord's request. The failure to produce these records upon demand shall be considered a default, subject to the provisions contained in ARTICLE 13 herein.

C. If Tenant is subject to the LWO, Tenant shall include the requirements of the ordinance, as defined in B.M.C. Chapter 13.27, in any and all subleases in which Tenant enters with regard to the subject Premises. Subtenants shall be required to comply with this ordinance with regard to any employees who spend 25% or more of their compensated time on the leased Premises.

D. If Tenant fails to comply with the requirements of the LWO and this Ground Lease, the Landlord shall have the rights and remedies described in this Section, in addition to any rights and remedies provided by law or equity.

E. Tenant's failure to comply with this Section shall constitute a default of the Ground Lease, upon which City may terminate this Ground Lease pursuant to ARTICLE 13.

F. In addition, at City's sole discretion, Tenant may be responsible for liquidated damages in the amount of \$50 per employee per day for each and every instance of an underpayment to an employee. It is mutually understood and agreed that Tenant's failure to pay any of its eligible employees at least the applicable living wage rate will result in damages being sustained by the City; that the nature and amount of the damages will be extremely difficult and impractical to fix; that the liquidated damages set forth herein is the nearest and most exact measure of damage for such breach that can be fixed at this time; and that the liquidated damage amount is not intended as a penalty of forfeiture for Tenant's breach.

**15.32 Berkeley Equal Benefits Ordinance (EBO).**

A. Tenant hereby agrees to comply with the provisions of the Berkeley Equal Benefits Ordinance, B.M.C. Chapter 13.29. If Tenant is currently or becomes subject to the Berkeley Equal Benefits Ordinance, Tenant will be required to provide all eligible employees with City mandated equal benefits during the Term of this Ground Lease, as defined in B.M.C. Chapter 13.29, as well as comply with the terms enumerated herein.

B. If Tenant is currently or becomes subject to the Berkeley Equal Benefits Ordinance, Tenant agrees to supply the City with any records the City deems necessary to determine compliance with this provision. Failure to do so shall be considered a default, subject to the provisions of ARTICLE 13.

C. If Tenant fails to comply with the requirements of this Section, City shall have the rights and remedies described in this Section, in addition to any rights and remedies provided by law or equity. Tenant's failure to comply with this Section shall constitute default of the Ground Lease, upon which City may terminate this Ground Lease pursuant to ARTICLE 13.

D. In addition, at City's sole discretion, Tenant may be responsible for liquidated damages in the amount of \$50.00 per employee per day for each and every instance of violation of this Section. It is mutually understood and agreed that Tenant's failure to provide

its employees with equal benefits will result in damages being sustained by City; that the nature and amount of these damages will be extremely difficult and impractical to fix; that the liquidated damages set forth herein is the nearest and most exact measure of damages for such breach that can be fixed at this time; and that the liquidated damage amount is not intended as a penalty or forfeiture for Tenant's breach.

**15.33 Audit.** In addition to any other Landlord audit right herein, the City Auditor's Office, or its designee, may conduct an audit of Tenant's financial and compliance records maintained in connection with the operations and services performed under this Ground Lease, and with the payments made under this Ground Lease. In the event of such audit, Tenant agrees to make all such financial and compliance records available to the Auditor's Office, or to its designee. City agrees to provide Tenant an opportunity to discuss and respond to any findings before a final audit report is filed.

**15.34 City Business License, Payment of Taxes, Tax I.D. Number.** Tenant has obtained a City business license as required by B.M.C. Chapter 9.04, and its license number is written below; or, Tenant is exempt from the provisions of B.M.C. Chapter 9.04 and has written below the specific B.M.C. section under which it is exempt. Tenant shall pay all state and federal income taxes and any other taxes due. Tenant certifies under penalty of perjury that the taxpayer identification number written below is correct.

**15.35 Survival.** The provisions of Sections 4.1 (Impositions), 5.6 (Alterations), 5.9 (Liens and Stop Notices), 6.2 (Governmental Requirements), 6.7 (General Standards of Maintenance), 7.2 (Hazardous Materials), 9.2 (Indemnity), 15.7 (Surrender) and any other obligation of Tenant that, by its terms or nature, is to be performed after or is to survive expiration or termination of this Ground Lease, shall survive such expiration or termination.

IN WITNESS WHEREOF, Landlord and Tenant have caused this Ground Lease to be executed on their behalf by their respective officers thereunto duly authorized as of the dates set forth below.

*[Signature Page Follows]*

**TENANT:**

BFHP Hope Center LP, a California limited partnership

By: \_\_\_\_\_

Print Name: \_\_\_\_\_

Its: \_\_\_\_\_

By: \_\_\_\_\_

Print Name: \_\_\_\_\_

Its: \_\_\_\_\_

Date: \_\_\_\_\_

**LANDLORD:**

CITY OF BERKELEY, a Charter city

By: \_\_\_\_\_

Dee Williams-Ridley  
City Manager

Date: \_\_\_\_\_

**Approved as to form:**

\_\_\_\_\_  
Farimah Brown, City Attorney

**Registered by:**

\_\_\_\_\_  
\_\_\_\_\_, City Auditor

**Attest:**

\_\_\_\_\_  
\_\_\_\_\_, City Clerk

**TENANT INFORMATION**

Tax Identification No. \_\_\_\_\_

Incorporated: Yes \_\_\_\_ No \_\_\_\_

Certified Woman Business Enterprise: Yes \_\_\_\_ No \_\_\_\_

Certified Minority Business Enterprise: Yes \_\_\_\_ No \_\_\_\_

Certified Disadvantaged Business Enterprise: Yes \_\_\_\_ No \_\_\_\_

City Business License No. \_\_\_\_\_, or  
Exempt pursuant to B.M.C. Section \_\_\_\_

**EXHIBIT A**

**PREMISES LEGAL DESCRIPTION**

The land referred to is situated in the City of Berkeley, County of Alameda, State of California, and is described as follows:

PARCEL ONE:

Parcel C, as shown on the Parcel Map 11051, filed \_\_\_\_\_, 2020 in Book \_\_\_ of Parcel Maps, Pages \_\_\_ and \_\_\_, Alameda County Records, EXCEPTING THEREFROM all buildings and improvements situated thereon, which buildings and improvements are and shall remain real property.

PARCEL TWO:

Easements for construction, maintenance, utilities, structural support and encroachment, set forth in that certain Declaration of and Agreement Regarding Covenants, Conditions and Restrictions Providing for Reciprocal Easements, Joint Use and Maintenance for Berkeley Way, dated \_\_\_\_\_, 2020, executed by the City of Berkeley and BRIDGE Berkeley Way LP and BFHP Hope Center LP, and recorded in Alameda County Records on \_\_\_\_\_, 2020 as Instrument No. \_\_\_\_\_.

Being a portion of APN 057-2053-022-01

EXHIBIT B

DEVELOPMENT SITE PARCEL MAP

*[Draft to be attached—final to be included before signing]*

**EXHIBIT C**

**STATUS OF CERTAIN DDA PROVISIONS**

1. The following DDA provisions have been fully satisfied or waived:
  - a. Section 2.1 (Conditions Precedent to Lease of Property).
  - b. Section 2.2 (Developer Deposit).
  - c. Section 2.3 (Development Schedule).
  - d. Section 2.4 (Development Services Agreement).
  - e. Section 2.5 (Creation of and Assignments to Permitted Lessees).
  - f. Section 2.6 (Developer Approval of Property).
  - g. Section 2.7 (Developer Approval of Title Matters).
  - h. Section 2.8 (Agreement on Leases).
  - i. Section 2.9 (Agreement on Reciprocal Easement Agreement).
  - j. Section 2.10 (Agreement on Completion Guaranty Agreement).
  - k. Section 2.11 (City and Other Governmental Approvals).
  - l. Section 2.12 (Financing Proposals and Financing Plans for the Development).
  - m. Section 2.13 (Evidence of Availability of Funds).
  - n. Section 2.14 (Construction Contract(s)).
  - o. Section 2.15 (Construction Bonds).
  - p. Section 2.16 (Building Permits).
  - q. Section 2.17 (Construction Drawings).
  - r. Section 2.18 (Final Subdivision Map).
  - s. Section 2.19 (No Default).
  - t. Section 2.20 (Permits and Approvals Final; Absence of Litigation).
  - u. Section 2.21 (Insurance).
  - v. Section 2.22 (Representations and Warranties; No Material Adverse Change).

- w. Article III (Design Requirements), except for Sections 3.7 and 3.8.
  - x. Article IV (Lease Disposition of Property) except for Sections 4.5 (see below), 4.6 (with respect to post-closing ad valorem taxes (if any) and other potential pre-closing and post-closing costs) and 4.7.
2. The following DDA provisions are terminated:
- a. Section 3.7 (No Change in Project Documents).
  - b. Section 3.8 (Additional Permits and Approvals).
  - c. Article VII (Assignment and Transfers).
  - d. Article VIII (Termination, Default and Remedies). (Remedies for default in any continuing obligation under the DDA shall be as provided in the Ground Lease.)
  - e. Section 9.3 (Enforced Delay).
  - f. Section 9.19 (Right of Entry to Perform Studies).
3. The following DDA provisions, attached hereto, remain in full force and effect, except to the extent provided below:
- a. Section 4.5 (Condition of Property) remains in full force and effect.
  - b. Section 4.6 (Costs of Escrow and Closing).
  - c. Section 4.7 (Obligations After Lease).
  - d. Article V (Construction of the Development) remains in full force and effect, and is incorporated into Section 5.1 of the Leases and the JDA.
  - e. Article VI (Ongoing Developer Obligations) (except to the extent modified in the Ground Lease or as attached hereto).
  - f. Section 9.1 (Notices, Demands and Communications), but only to the extent notices are required under the DDA, and not some other agreement with its own notice provisions.
  - g. Section 9.2 (Non-Liability of City Officials, Employees and Agents), Section 9.4 (Inspection of Books and Records), Section 9.5 (Provision Not Merged with Leases) and Section 9.6 (Title of Parts and Sections) shall remain in full force and effect.
  - h. Section 9.7 (Indemnification) shall remain in full force and effect against Developer except to the extent assumed by BRIDGE LP and BFHP LP, and otherwise in full force and effect against BRIDGE LP and BFHP LP.
  - i. Section 9.8 (Applicable Law), Section 9.9 (No Brokers), Section 9.10 (Severability), Section 9.11 (Binding Upon Successors), Section 9.12 (Parties Not Co-Venturers), Section 9.13 (Time of the Essence), Section 9.14 (Action by the City), Section 9.15 (Discretion Retained by City), Section 9.16 (Representations and Warranties by Developer), and



Section 9.17 (Multiple Originals; Complete Understanding of the Parties), remain in full force and effect.

j. Except as provided in Leases Subsection 1.1A, Section 9.18 (Conflict Among City Documents) remains in full force and effect to the extent any applicable DDA provision remains in effect.

EXHIBIT D

SITE RECIPROCAL EASEMENT AGREEMENT (REA 1)

*[to be provided]*



EXHIBIT E

RESOLUTION NO. AAAA-N.S.

*[to be attached]*



EXHIBIT F

INITIAL LEASEHOLD MORTGAGES AND MORTGAGEES

**[to be provided—identify “Senior Leasehold Mortgagee” if any and include notice addresses]**

EXHIBIT G

CITY FINANCING DOCUMENTS

*[to be provided]*







1-8-2020

Exhibit C

**GROUND LEASE  
2012 BERKELEY WAY  
(Berkeley Way Permanent Supportive Housing Apartments)**

by and between

**CITY OF BERKELEY  
("Landlord")**

and

**BFHP Hope Center, LP**

**("Tenant")**

Dated \_\_\_\_\_, 2020

TABLE OF CONTENTS  
(Ground Lease - Berkeley Way Permanent Supportive Housing Apartments)

	Page
ARTICLE 1. OVERVIEW AND GENERAL .....	1
<b>1.1 Overview</b> .....	1
<b>1.2 Ground Lease and Possession</b> .....	1
<b>1.3 Ownership of Premises Improvements</b> .....	1
<b>1.4 Changes to Premises and Parcel Map</b> .....	2
<b>1.5 Tenant’s Organizational Documents</b> .....	2
ARTICLE 2. GROUND LEASE TERM.....	2
<b>2.1 Term</b> .....	2
ARTICLE 3. RENT .....	2
<b>3.1 Rent</b> .....	2
<b>3.2 No Cost to Landlord: No Counterclaim, No Abatement</b> .....	2
<b>3.3 Additional Rent</b> .....	2
<b>3.4 Additional Consideration</b> .....	3
ARTICLE 4. TAXES AND ASSESSMENTS; SERVICES AND UTILITIES.....	3
<b>4.1 Impositions</b> .....	3
<b>4.2 Statement Regarding Possessory Interest Tax</b> .....	4
<b>4.3 Services and Utilities</b> .....	4
ARTICLE 5. DEVELOPMENT OF PREMISES IMPROVEMENTS; ALTERATIONS.....	4
<b>5.1 General</b> .....	4
<b>5.2 Commencement and Completion of Construction</b> .....	4
<b>5.3 Prior Development Matters</b> .....	5
<b>5.4 Non-Responsibility of Landlord</b> .....	5
<b>5.5 No Change in Project Documents</b> .....	5
<b>5.6 Alterations</b> .....	6
<b>5.7 Construction Standards</b> .....	6
<b>5.8 Protection of Landlord</b> .....	8
<b>5.9 Liens and Stop Notices</b> .....	8
<b>5.10 Notice</b> .....	8
<b>5.11 Miscellaneous</b> .....	8
ARTICLE 6. USE OF PREMISES, COMPLIANCE WITH LAWS .....	9
<b>6.1 General</b> .....	9
<b>6.2 Governmental Requirements</b> .....	9
<b>6.3 Tenant’s Right to Contest</b> .....	10
<b>6.4 Nuisance</b> .....	10

**TABLE OF CONTENTS**  
**(Ground Lease - Berkeley Way Permanent Supportive Housing Apartments)**

	<b>Page</b>
<b>6.5 General Use Prohibitions</b> .....	10
<b>6.6 Non-Discrimination</b> .....	11
<b>6.7 General Standards of Maintenance</b> .....	11
<b>6.8 Landlord’s Status as a Landowner</b> .....	11
<b>6.9 Regulatory Approvals Generally</b> .....	11
<b>ARTICLE 7. CONDITION OF PREMISES; HAZARDOUS MATERIALS; LANDLORD’S RIGHT OF ENTRY</b> .....	12
<b>7.1 Landlord’s Disclaimers and Tenant’s Acknowledgements</b> .....	12
<b>7.2 Hazardous Materials</b> .....	12
<b>7.3 Landlord’s Right to Enter Premises and Premises Improvements</b> .....	13
<b>ARTICLE 8. OWNERSHIP OF IMPROVEMENTS AND PERSONAL PROPERTY</b> .....	13
<b>8.1 Ownership of Premises Improvements During Term</b> .....	13
<b>8.2 Ownership of Premises Improvements at Termination or Expiration</b> .....	13
<b>8.3 Removal and Ownership of Personal Property at Termination or Expiration</b> .....	13
<b>ARTICLE 9. INSURANCE AND INDEMNITY</b> .....	14
<b>9.1 General Insurance Requirements</b> .....	14
<b>9.2 Indemnity</b> .....	15
<b>ARTICLE 10. DAMAGE OR DESTRUCTION</b> .....	16
<b>10.1 Restoration</b> .....	16
<b>10.2 Waiver</b> .....	17
<b>10.3 Determination of Extent of Destruction, Interference with Use</b> .....	17
<b>10.4 Procedures for Repair and Restoration</b> .....	17
<b>ARTICLE 11. CONDEMNATION</b> .....	18
<b>11.1 Definitions</b> .....	18
<b>11.2 Parties’ Rights and Obligations to be Governed by Ground Lease</b> .....	18
<b>11.3 Total Taking</b> .....	18
<b>11.4 Effect of Partial Taking</b> .....	18
<b>11.5 Restoration of Premises Improvements</b> .....	19
<b>11.6 Waiver of CCP Section 1265.130</b> .....	19
<b>11.7 Award</b> .....	19
<b>ARTICLE 12. ASSIGNMENT AND SUBLETTING</b> .....	19
<b>12.1 Assignment</b> .....	19
<b>12.2 Subleases</b> .....	20

**TABLE OF CONTENTS**  
**(Ground Lease - Berkeley Way Permanent Supportive Housing Apartments)**

	<b>Page</b>
ARTICLE 13. TENANT DEFAULTS AND LANDLORD'S REMEDIES .....	20
<b>13.1 Defaults by Tenant</b> .....	20
<b>13.2 Remedies</b> .....	21
<b>13.3 Damages</b> .....	22
<b>13.4 Landlord's Right to Cure Tenant's Default</b> .....	22
<b>13.5 Guarantor Performance Under Completion Guaranty</b> .....	22
ARTICLE 14. MORTGAGEE PROTECTION PROVISIONS.....	23
<b>14.1 Right to Encumber</b> .....	23
<b>14.2 Leasehold Mortgagee as Third Party Beneficiary</b> .....	23
<b>14.3 Notice to Leasehold Mortgagee</b> .....	23
<b>14.4 Right of Leasehold Mortgagee to Cure</b> .....	23
<b>14.5 Limitation on Liability of Leasehold Mortgagee</b> .....	24
<b>14.6 Estoppel Certificates</b> .....	24
<b>14.7 Registration of Leasehold Mortgages</b> .....	25
<b>14.8 New Ground Lease</b> .....	25
<b>14.9 Rights of Investor</b> .....	26
<b>14.10 Transfers</b> .....	26
<b>14.11 Permitted Use Requirements</b> .....	26
<b>14.12 Further Ground Lease Amendments</b> .....	26
ARTICLE 15. MISCELLANEOUS.....	27
<b>15.1 Holding Over</b> .....	27
<b>15.2 Attorneys' Fees</b> .....	27
<b>15.3 Quiet Possession</b> .....	27
<b>15.4 Force Majeure</b> .....	27
<b>15.5 Notices</b> .....	27
<b>15.6 Waiver</b> .....	28
<b>15.7 Surrender</b> .....	28
<b>15.8 Binding</b> .....	28
<b>15.9 Disclaimer of Partnership</b> .....	28
<b>15.10 Quitclaim</b> .....	28
<b>15.11 Interpretation</b> .....	28
<b>15.12 Severability</b> .....	28
<b>15.13 Computation of Time</b> .....	29

**TABLE OF CONTENTS**  
**(Ground Lease - Berkeley Way Permanent Supportive Housing Apartments)**

	<b>Page</b>
15.14 Legal Advice.....	29
15.15 Time of Essence.....	29
15.16 Nonliability of Officials, Employees, etc.....	29
15.17 Assignment by Landlord .....	29
15.18 Applicable Law .....	30
15.19 Covenants and Conditions.....	30
15.20 Integration .....	30
15.21 Amendments to this Ground Lease.....	30
15.22 Proprietary and Governmental Roles: Actions by City .....	30
15.23 City Manager Authority and Limitations.....	30
15.24 Brokerage Commissions .....	30
15.25 City Non-Discrimination Ordinance.....	31
15.26 Non-Discrimination Against Persons With Disabilities.....	31
15.27 Conflict of Interest Prohibited.....	31
15.28 Nuclear Free Berkeley .....	32
15.29 Required Accessibility Disclosure.....	32
15.30 Oppressive States.....	32
15.31 Berkeley Living Wage Ordinance (LWO).....	33
15.32 Berkeley Equal Benefits Ordinance (EBO).....	34
15.33 Audit .....	34
15.34 City Business License, Payment of Taxes, Tax I.D. Number .....	34
15.35 Survival.....	34

TABLE OF CONTENTS  
(Ground Lease - Berkeley Way Permanent Supportive Housing Apartments)

Page

LIST OF EXHIBITS

<u>Exhibit A</u>	Premises Legal Description
<u>Exhibit B</u>	Development Site Parcel Map
<u>Exhibit C</u>	Status of Certain DDA Provisions
<u>Exhibit D</u>	Site Reciprocal Easement Agreement (REA 1)
<u>Exhibit D1</u>	Hope Center Reciprocal Easement Agreement (REA 2)
<u>Exhibit E</u>	City Resolution No. AAAA-N.S. [ <b><i>Approving the final Leases</i></b> ]
<u>Exhibit F</u>	Initial Leasehold Mortgages and Mortgagees
<u>Exhibit G</u>	City Financing Documents

**BASIC LEASE INFORMATION**  
**(Ground Lease - Berkeley Way Permanent Supportive Housing Apartments)**

1. **“Landlord”**

CITY OF BERKELEY, a Charter city

Notice Address:

City of Berkeley  
2180 Milvia Street  
Berkeley, California 94704  
Attention: City Manager  
Telephone: (510) 981-7000  
Facsimile: (510) 981-7099

With a copy to:

City of Berkeley  
2180 Milvia Street, 4<sup>th</sup> floor  
Berkeley, California 94704  
Attention: City Attorney  
Telephone: (510) 981-6991  
Facsimile: (510) 981-6960

And

City of Berkeley HHCS  
2180 Milvia Street, 2<sup>nd</sup> floor  
Berkeley, California 94704  
Attention: Housing & Community Services Manager  
Telephone: (510) 981-5400  
Facsimile: (510) 981-5450

2. **“Tenant”**

BFHP Hope Center LP

Notice Address:

BFHP Hope Center LP  
c/o BRIDGE Housing Corporation  
600 California Street, Suite 900  
San Francisco, CA 94108  
Attn: General Counsel

BFHP Hope Center LP  
c/o Berkeley Food and Housing Project  
1901 Fairview Street  
Berkeley, CA 94703  
Attn: Executive Director

3. **“Ground Lease Date”**

The date set forth in the first paragraph below.

4. **“DDA”**

That certain Disposition and Development Agreement (Berkeley Way Development), originally dated June 8, 2016 between Landlord and Bridge Housing Corporation, a California nonprofit public benefit corporation, as amended by First Amendment to Disposition and Development Agreement dated August 27, 2018, as



**BASIC LEASE INFORMATION**  
**(Ground Lease - Berkeley Way Permanent Supportive Housing Apartments)**

partially assigned to Tenant pursuant to that certain Partial Assignment and Assumption Agreement dated December 17, 2018 and recorded in Official Records of Alameda County on December 21, 2018 as Instrument No. 18-241567, as amended by the Second Amendment to Disposition and Development Agreement, dated February 1, 2019 and recorded in Official Records of Alameda County on February 14, 2019 as Instrument No. 2019029062, and as further partially assigned to BRIDGE Berkeley Way LP and amended pursuant to that certain Assignment and Third Amendment to DDA dated \_\_\_\_\_, 2020 and recorded in Official Records of Alameda County on \_\_\_\_\_, 2020 as Instrument No. \_\_\_\_\_. See **Exhibit C** hereto.

5. **“Premises”** The Premises is described in **Exhibit A**, being primarily Parcel **A** of the Parcel Map (defined below).

6. **“Development Site” or “Site”** That certain approximately 1-acre (approximately 41,000 square feet) parcel of real property generally located at 2012 Berkeley Way, between Milvia Street and Shattuck Avenue (previously APN 57-2053-22-1) in the City of Berkeley, which is the subject of the DDA.

The Development Site has been divided into three parcels, pursuant to that certain Parcel Map 11051, filed \_\_\_\_\_, 2020 in Book \_\_\_ of Parcel Maps, Pages \_\_\_ and \_\_, Alameda County Records (the **“Parcel Map”**), a copy of which is attached hereto as **Exhibit B**. Generally, the three parcels are the **“BRIDGE Affordable Parcel”** (Parcel Map Parcel C), the **“Permanent Supportive Housing Parcel”** (Parcel Map Parcel A), and the **“Temporary Housing Parcel”** (Parcel Map Parcel B).

7. **“Development” or “Project”** The entire development project to be planned, entitled, developed, financed, designed, constructed, operated and maintained on the Development Site. The overall Development is a six story building with approximately 140,000 square feet of gross interior floor space, with associated landscaping and hardscape, and includes:

- The Temporary Housing Parcel and the Temporary Housing Improvements. The **“Temporary Housing Improvements”** consists of approximately 44 beds of temporary housing, a services center and administrative office space. The Temporary Housing Improvements are located within the Temporary Housing Parcel.
- The Permanent Supportive Housing Parcel and the

**BASIC LEASE INFORMATION**  
**(Ground Lease - Berkeley Way Permanent Supportive Housing Apartments)**

Permanent Supportive Improvements. The “**Permanent Supportive Housing Improvements**” consist of approximately 53 permanent supportive housing units and supportive service spaces. The Permanent Supportive Housing Improvements are located within the Permanent Supportive Housing Parcel.

- The BRIDGE Affordable Parcel and the BRIDGE Improvements. The “**BRIDGE Improvements**” consist of 89 affordable housing units (including one manager’s unit) and related improvements. The BRIDGE Improvements are located within the BRIDGE Affordable Parcel.

8. “**Permitted Use**” Supportive housing, subject to the Regulatory Requirements and all other provisions of this Ground Lease.

9. “**Premises Improvements**” The Permanent Supportive Housing Improvements, collectively, together with all additions, alterations, modifications, replacements and improvements from time to time pursuant to this Ground Lease.

10. “**REA 1**” or “**Site REA**” or “**Berkeley Way REA**” That certain Declaration of and Agreement Regarding Covenants, Conditions and Restrictions Providing for Reciprocal Easements, Joint Use and Maintenance for Berkeley Way, dated \_\_\_\_\_, 2020, executed by the City of Berkeley and BRIDGE Berkeley Way LP and BFHP Hope Center LP, and recorded in Alameda County Records on \_\_\_\_\_, 2020 as Instrument No. \_\_\_\_\_, substantially in form attached hereto as **Exhibit D**.

11. “**REA 2**” or “**Hope Center REA**” That certain Declaration of and Agreement Regarding Covenants, Conditions and Restrictions Providing for Reciprocal Easements, Joint Use and Maintenance for the BFHP Hope Center, dated \_\_\_\_\_, 2020, executed by the City of Berkeley and BFHP Hope Center LP, and recorded in Alameda County Records on \_\_\_\_\_, 2020 as Instrument No. \_\_\_\_\_, substantially in form attached hereto as **Exhibit D1**.

12. “**Regulatory Requirements**” Includes, collectively, (i) that certain Regulatory Agreement and Declaration of Restrictive Covenants (Berkeley Way Permanent Supportive Housing Apartments), dated \_\_\_\_\_, 20\_\_, between Landlord and Tenant and recorded in Official Records of Alameda County on \_\_\_\_\_, 2020 as Instrument No.

**BASIC LEASE INFORMATION**  
**(Ground Lease - Berkeley Way Permanent Supportive Housing Apartments)**

- \_\_\_\_\_, and any amendments approved by Landlord and Tenant, and (ii) any regulatory or affordability agreement or other covenant, condition or restriction in favor of Landlord and recorded against the Premises.
13. **“Leasehold Mortgage,” “Permitted Leasehold Mortgage” and “Senior Leasehold Mortgage”** As identified in **Exhibit F** attached hereto. See also ARTICLE 14 below.
14. **“Investor(s)”** *[to be provided, including notice addresses]*
15. **“Term”** The period of time commencing on the Ground Lease Date and ending on the last day of the month in which the 75<sup>th</sup> anniversary of the Ground Lease Date occurs, subject to earlier termination as provided elsewhere in this Ground Lease.
16. **“Developer”** BRIDGE Housing Corporation, a California nonprofit public benefit corporation.
17. **“BFHP”** Berkeley Food and Housing Project, a California religious] corporation
18. **“JDA”** Joint Development Agreement, dated \_\_\_\_\_, 20\_\_ between Tenant and BRIDGE Berkeley Way LP, a California limited partnership.
19. **“Developer Agreement”** Prior to the Ground Lease Date, the Development Services Agreement, dated \_\_\_\_\_, 20\_\_ among Developer, Tenant and BRIDGE Berkeley Way LP, a California limited partnership; and after the Ground Lease Date the Development Services Agreement, dated \_\_\_\_\_, 20\_\_ between Developer and Tenant.
20. **“Construction Schedule”** The final approved Construction Schedule for the Premises and Project, as amended from time to time pursuant to ARTICLE 5 below.
21. **[Intentionally Omitted]**
22. **“Premises Substantial Completion”** Obtaining a temporary certificate of occupancy for the Premises and Project.
23. **“Premises Substantial Completion Date”** The earlier of 40 months following the commencement of Project construction and July 31, 2024.
24. **“Guarantor” and** Developer, as **[Guarantor]** under that certain **[Construction Completion Guaranty]** in favor of the

**BASIC LEASE INFORMATION**  
**(Ground Lease - Berkeley Way Permanent Supportive Housing Apartments)**

- “Completion Guaranty”** Landlord, dated on or about the Ground Lease Date, together with such changes as Landlord may approve.
25. **“Base Rent”** \$500 for the entire Term.
26. **“Additional Rent”** Is defined in Section 3.3 below.
27. **“Interest Rate”** The maximum rate permitted under Section 1(2) of Article XV of the California Constitution.
28. **“County”** The County of Alameda, California.
29. **“State”** The State of California.
30. **“City”** City of Berkeley, California
31. **“Code”** The Internal Revenue Code of 1986, as amended from time to time.
32. **“CPI”** The Consumer Price Index (1982-84=100) for all Urban Consumers published by the United States Department of Labor, Bureau of Labor Statistics for the San Francisco-Oakland-Hayward area, or any successor thereof.
33. **“City Financing Documents”** See Section 1.2 below and **Exhibit G** attached hereto.

The Basic Ground Lease Information set forth above and the Exhibits attached hereto are incorporated into and made a part of the following Ground Lease.

**LANDLORD'S INITIALS** \_\_\_\_\_

**TENANT'S INITIALS** \_\_\_\_\_

**GROUND LEASE  
2012 BERKELEY WAY  
(Berkeley Way Permanent Supportive Housing Apartments)**

THIS GROUND LEASE (“**Ground Lease**”) is made and entered into this \_\_\_ day of \_\_\_\_\_, 2020 (the “**Ground Lease Date**”), by and between the Landlord and Tenant identified in the Basic Ground Lease Information, who agree as follows:

**ARTICLE 1.  
OVERVIEW AND GENERAL**

**1.1 Overview.**

A. General Purpose of Development; Authority. Landlord owns the Site. Landlord entered into the DDA to cause the construction and operation of the Development on the Site for temporary, affordable and permanent supportive housing, and homeless services to help address the City’s homeless and affordability crisis, existing as of the Ground Lease Date. This Ground Lease facilitates one component of the Development. Landlord is entering into two additional ground leases, with an affiliate of Tenant, to implement the other two components of the Development, which components are further described in Basic Lease Information Section 7. In the event of a conflict between the DDA and this Ground Lease, this Ground Lease supersedes the DDA and will control. (See also Exhibit C hereto.) Landlord’s execution of this Ground Lease and the additional ground leases was authorized by City Council Resolution No. AAAA-N.S. attached hereto as Exhibit E.

B. Specific Purpose of Ground Lease. Landlord is entering into this Ground Lease to permit Tenant to construct, operate and maintain the Premises Improvements for the Permitted Use.

C. Regulatory Requirements. The parties intend that the Regulatory Requirements will survive for the full term therein, notwithstanding any prior termination or expiration of this Ground Lease or (except as provided in ARTICLE 14) foreclosure of any Permitted Leasehold Mortgage.

D. City Financing Documents. Nothing in this Ground Lease shall limit any City right under any regulatory or financing agreements between the City and Tenant (or by Tenant for the benefit of City), or under any Regulatory Requirement.

**1.2 Ground Lease and Possession.** For and in consideration of the payment of Rent and the performance of all the covenants and conditions of this Ground Lease, as of the Ground Lease Date Landlord hereby leases and demises to Tenant, and Tenant hereby leases and hires from Landlord, the Premises, for the Term and upon the covenants and conditions set forth herein. On the Ground Lease Date, Tenant shall obtain exclusive possession of the Premises.

**1.3 Ownership of Premises Improvements.** At all times during the Term of this Ground Lease, (i) the Premises Improvements shall be owned by Tenant, (ii) Tenant alone shall be entitled to all of the tax attributes of ownership, including, without limitation, the right to claim depreciation or cost recovery deductions and the right to claim the low-income housing tax credit described in Section 42 of the Internal Revenue Code of 1986, as amended, and (iii)

Tenant shall have the right to amortize capital costs and to claim any other federal or state tax benefits attributable to the Premises Improvements.

**1.4 Changes to Premises and Parcel Map.** Tenant shall not alter the definition of the Premises, modify the Parcel Map, or further subdivide, by map, subdivision map, or otherwise, the Premises or any portion thereof, without the prior written consent of Landlord, which Landlord may grant or withhold in its sole discretion. Nothing in this Section shall prevent Tenant from entering into residential leases as provided herein and in the Regulatory Agreement.

**1.5 Tenant's Organizational Documents.** Tenant has previously provided Landlord with correct and complete copies of organizational documents for itself and (as applicable) its general partner(s) and managing member(s), including without limitation articles of organization, certificates of limited partnership, limited partnership agreements, limited liability company agreements, and the like. Tenant will provide Landlord copies of all amendments and modifications promptly following adoption thereof, and copies of such other organizational documents as Landlord may reasonably request from time to time. Any such amendment or modification which materially alters Landlord's rights herein (such as by giving new rights to Investors), or under the Site REA, Hope Center REA, or Regulatory Requirements is subject to Landlord's reasonable consent.

## **ARTICLE 2. GROUND LEASE TERM**

**2.1 Term.** The Term of this Ground Lease shall be as set forth in the Basic Ground Lease Information.

## **ARTICLE 3. RENT**

**3.1 Rent.** Tenant shall pay the Base Rent specified in the Basic Ground Lease Information on or before the Ground Lease Date. Base Rent and any Additional Rent (collectively, "**Rent**") shall be paid without notice or demand, and, except as specifically provided for in this Ground Lease, without offset, deduction or credit. All Rent (other than Additional Rent payable to entities other than Landlord) shall be payable in lawful money of the United States to Landlord at the address stated herein or to such other persons or at such other places as Landlord may designate from time-to-time in writing.

**3.2 No Cost to Landlord: No Counterclaim, No Abatement.** Except as otherwise expressly provided in this Ground Lease, all Rent payable under this Ground Lease shall be absolutely net to Landlord. Except as otherwise expressly provided in this Ground Lease, Tenant shall pay Rent without assertion of any counterclaim, setoff, deduction or defense and without abatement, suspension, deferment, diminution or reduction.

**3.3 Additional Rent.** "**Additional Rent**" means all sums, Impositions (as defined in Section 4.1 below), costs, expenses, and other payments for which Tenant is responsible pursuant to this Ground Lease. Tenant's obligation to pay Additional Rent shall begin to accrue on the Ground Lease Date and shall continue to accrue throughout the Term. Additional Rent shall be payable by Tenant to the appropriate party on or before the date required by this Ground Lease. In addition to and not by way of limitation of Landlord's rights under specific provisions of this Ground Lease, Landlord shall at all times have the right (at its

sole election and without any obligation to do so) to advance on behalf of Tenant any amount, subject to Tenant's right to contest such charges and provided that (except in case of emergency calling for immediate payment) Landlord shall first have given Tenant no less than 10 business days' advance written notice of Landlord's intent to advance such amounts on behalf of Tenant. No advance by Landlord shall operate as a waiver of any Landlord right under this Ground Lease and Tenant shall remain fully responsible for the performance of its obligations under this Ground Lease. All amounts advanced by Landlord as provided in this Section shall constitute "**Additional Rent**" under this Ground Lease, shall be due and payable by Tenant to Landlord within five business days of Tenant's receipt of an invoice from Landlord therefor, and shall bear interest at the Interest Rate until paid in full.

**3.4 Additional Consideration.** In addition to the Rent and Additional Rent provided for herein, consideration for this Ground Lease shall also be and is Tenant's full and complete compliance with all terms, conditions, warranties and covenants contained in the Regulatory Requirements and this Ground Lease relating to the planning, entitling, developing, financing, designing, constructing, operating and maintaining the Premises and Premises Improvements.

#### **ARTICLE 4. TAXES AND ASSESSMENTS; SERVICES AND UTILITIES**

**4.1 Impositions.** Tenant shall pay or cause to be paid, when due to the proper authority, any and all valid taxes, assessments, impositions, fees and similar charges on the Premises or Premises Improvements which become effective after the Ground Lease Date, including all taxes levied or assessed on the possession, use or occupancy of the Premises (as distinguished from the ownership of the Premises), and all taxes levied or assessed on the ownership, possession, use or occupancy of the Premises Improvements (collectively, "**Impositions**"). Tenant shall not permit any Impositions to become a defaulted lien on the Premises or Premises Improvements; provided, however, that in the event any Imposition is payable in installments, Tenant may make, or cause to be made, payment in installments; and, provided further, that Tenant may contest the legal validity or the amount of any tax, assessment, imposition, fee or similar charge, through such proceedings as Tenant considers necessary or appropriate, and Tenant may defer the payment thereof so long as the validity or amount thereof shall be contested by Tenant in good faith and without expense to the Landlord. In the event of any such contest, Tenant shall protect, defend and indemnify the Landlord against all loss, cost, expense or damage resulting there from, and should Tenant be unsuccessful in any such contest, Tenant shall forthwith pay, discharge, or cause to be paid or discharged, such tax, assessment, imposition, fee or other similar charge. Landlord hereby consents to and shall reasonably cooperate and assist with Tenant applying for and obtaining any applicable exemptions from taxes or assessments levied on the Premises, the Premises Improvements and on Tenant's interest therein. Tenant shall have no obligation to pay Impositions pursuant to this Section that are due and payable prior to the Ground Lease Date, including without limitation any taxes, assessments, impositions, fees or other charges levied against the Premises which are incurred prior to the Ground Lease Date. Any Imposition relating to a period, only a part of which is included within the Term, shall be prorated as between Landlord and Tenant so that Landlord shall pay (if Landlord is subject to such Impositions) the portion of Impositions attributable to any period prior to the Ground Lease Date or subsequent to the expiration of this Ground Lease, and Tenant shall pay the portion thereof attributable to any period during the Term. Nothing contained in this Ground Lease shall be deemed to require the payment by Tenant of any income, franchise, estate, inheritance, succession or capital levy tax of Landlord.

**4.2 Statement Regarding Possessory Interest Tax.** This Ground Lease creates a possessory property interest in Tenant. Tenant acknowledges and agrees that Tenant's leasehold and/or other real property interests may be subject to property taxation, and Tenant or the party in whom the possessory property interest is vested may be subject to the payment of property taxes levied on the interest. Such taxes (unless Tenant establishes an exemption) shall be paid by Tenant as part of Impositions as provided in this Ground Lease.

**4.3 Services and Utilities.** Tenant shall pay, or cause to be paid, all charges that are incurred by Tenant or that might be a charge or lien against the Premises or Premises Improvements for gas, water, electricity, telephone or other communication service, janitorial service, debris removal, or any other utility or service used, rendered or supplied upon or in connection with the Premises Improvements, throughout the Term ("**Utilities**"). Such charges shall include the cost of installing and metering such utility services. Tenant shall maintain, repair and (if necessary) replace all Utility facilities and installations in, on, about or otherwise serving the Premises or Premises Improvements. Landlord grants to Tenant the right to grant to public entities or public service corporations, for the purpose of serving only the Premises during the Term of this Ground Lease, rights-of-way or easements on or over the Site, for poles or conduits or both, and for other utilities and municipal or special district services; provided, however, that Tenant shall not grant any such rights of way or easements that would adversely affect or create safety problems in connection with the use or operation, or access to and from, the BRIDGE Affordable Parcel or Temporary Housing Parcel, or any adjoining property. Landlord shall join in the execution of or consent to any such any such rights of way or easements. Tenant shall promptly provide to Landlord copies of all rights-of-way and easements so granted. Tenant, or third parties other than Landlord, shall bear all costs and expenses incurred in connection with the granting of any such rights-of-way and easements.

**ARTICLE 5.  
DEVELOPMENT OF PREMISES IMPROVEMENTS; ALTERATIONS**

**5.1 General.** Tenant shall plan, entitle, develop, finance, design and construct the Premises Improvements on the Premises pursuant to and in compliance with all the terms and conditions set forth in DDA Article 5, this ARTICLE 5, the JDA, the Developer Agreement and the Construction Schedule. In the event of any conflict between this Ground Lease and the DDA, this Ground Lease shall control. Without limiting the foregoing:

A. Tenant shall notify Landlord regarding (i) any material breaches or defaults, and (ii) any schedule issues that may impair Tenant's ability to substantially complete the Premises Improvements prior to the date contained in the latest Construction Schedule; and

B. Tenant shall require its General Contractor performing the initial construction of the Premises Improvements to prepare all schedule updates required by the Construction Contract and promptly provide copies to Landlord.

**5.2 Commencement and Completion of Construction.** Tenant shall commence construction of the Premises Improvements no later than 30 days following the Ground Lease Date, and shall use diligent efforts to complete construction (subject to Force Majeure delays as defined in delays as defined in Section 15.4 below) no later than the Premises Substantial Completion Date. As between Tenant and Landlord, Tenant shall bear all costs and expenses to complete, or cause the completion of, the Premises Improvements within the time period set forth in the Construction Schedule, including without limitation any cost



overruns and changes (regardless of Landlord's approval of any changes) for the Premises Improvements.

### **5.3 Prior Development Matters**

A. Site and Title Approvals. By its execution and delivery of this Ground Lease, Tenant confirms that it has approved all matters relating to the Site and title matters, as provided in DDA Sections 2.6, 2.7 and 4.5.

B. City and Governmental Approvals; CEQA Litigation. By its execution and delivery of this Ground Lease, Tenant and Landlord confirm that Tenant has obtained all City Approvals (as defined in the DDA). Tenant confirms that it has obtained all other governmental approvals necessary for the development and operation of the Premises and the Premises Improvements, as provided in DDA Section 2.11. If any third party commences litigation objecting to or otherwise challenging any action or omission under California Environmental Quality Act (“**CEQA**”) with respect to the Premises or any of Landlord's land use approvals relating to this Ground Lease, the Premises Improvements or the use or occupancy thereof, Tenant shall indemnify, hold harmless and defend Landlord (with defense counsel selected by Tenant and reasonably acceptable to Landlord) for any and all liabilities, losses, costs or expenses, including attorney fees or fees for the use of experts or consultants, incurred as a result of any such claim, litigation or challenge. No settlement shall be entered into without Landlord's full consent and approval.

C. Construction Drawings and Specifications. By its execution and delivery of this Ground Lease, Tenant and Landlord confirm that Tenant has obtained all required City approvals for the Final Construction Drawings in accordance with DDA Sections 2.17 and 3.4.

**5.4 Non-Responsibility of Landlord**. Tenant shall be solely responsible for all aspects of its conduct in connection with the Premises Improvements, including, but not limited to, the quality and suitability of the final drawings and specifications, the supervision of construction work, and the qualifications, financial condition, and performance of all architects, engineers, contractors, subcontractors, suppliers, consultants, and property managers. Any review, inspection or approval undertaken by Landlord is solely for the purpose of determining whether the Tenant is properly discharging its obligations to Landlord, and should not be relied upon by Tenant, Developer or any other third parties as a warranty or representation by Landlord as to the quality of the design or construction of the Premises Improvements.

**5.5 No Change in Project Documents**. From and after the Ground Lease Date until Premises Substantial Completion, except as set forth in DDA Section 5.1, Tenant shall not make any Material Change to the Final Construction Drawings or permit others to make any Material Change without the Landlord's prior written approval. As used in this Section 5.5 “**Material Change**” means (i) any change in the work the cost of which exceeds Two Hundred Fifty Thousand Dollars (\$250,000); or (ii) any set of changes in the work the cost of which cumulatively exceeds Five Hundred Thousand Dollars (\$500,000); or (iii) any material change in building materials or equipment, or the structural or architectural design or appearance of the Development as provided for in the plans and specifications approved by the City Building Department. From and after the Ground Lease Date until Premises Substantial Completion, Tenant shall not make any changes to the Construction Schedule or permit others to do so, without the Landlord's prior written approval, which shall not unreasonably be withheld.

**5.6 Alterations.**

A. Alterations shall also be governed by this Ground Lease, including without limitation applicable provisions of this ARTICLE 5. “**Alterations**” include modifications or additions to the Premises Improvements following Premises Substantial Completion, including without limitation Material Alterations. “**Material Alterations**” means (a) the construction of any new additional building or structure, (b) an increase in the bulk or height of the Premises Improvements, (c) any material alteration of exterior architectural designs, colors or materials (unless the applicable exterior component is not reasonably available or does not meet current code requirements, and Tenant uses materials of equal quality, durability, design standards, and appearance to the materials originally installed), or (d) reconstruction following fire or other casualty in excess of \$300,000 (subject to adjustment pursuant to the CPI from and after the Ground Lease Date). Any Alterations shall be in compliance with applicable Laws and permits, shall at all times be of first-class construction and architectural design. Material Alterations shall be in accordance with all plans and specifications therefor submitted to and approved by Landlord as set forth below. No material changes to such approved plans and specifications shall be made without Landlord’s prior written approval. All Alterations shall be diligently prosecuted, completed, and accomplished without cost or expense to Landlord, by licensed contractors, and in a first-class and workmanlike manner.

B. Except with Landlord’s prior written consent, which may be granted or denied in Landlord’s reasonable discretion, Tenant shall not make or cause to be made any Material Alterations as set forth below. If Tenant at any time following Premises Substantial Completion desires to undertake any Material Alterations, Tenant shall, prior to the commencement of such work, prepare or cause to be prepared, at its sole expense, and shall submit to Landlord for its review, cost estimates, plans and specifications for such work, showing, without limitation, scaled elevations, scaled floor plans, design concepts, dimensions, material selection, colors, signing (if any) and such additional information as is reasonably requested by Landlord to make an informed decision on such submission. The plans and specifications shall comply with this Ground Lease and shall be in compliance with applicable Laws. Landlord shall approve or disapprove such submitted plans within 30 days of receipt of complete plans and specifications meeting the requirements of this subsection. In the event Landlord disapproves a submittal pursuant to this Section, Landlord shall submit a list of reasons for the disapproval to the Tenant together with its notice of such disapproval. Failure of the Landlord to approve or disapprove such plans and specifications within such 30-day period shall be deemed to be Landlord’s disapproval. Nothing herein or in any other agreement relating to the Development shall require Landlord to approve Material Alterations which would cause the Building (including any solar canopy or other energy facilities) to be greater than 206 feet high or include more than 167,000 interior square feet.

**5.7 Construction Standards.** The following standards (as applicable) shall apply to the design and construction of all Premises Improvements and Alterations under this Ground Lease.

A. Approval of Contractor and Materials. Landlord’s approval of Tenant’s contractor or other person engaged to perform the work is required for all Premises Improvements and Alterations with an aggregate cost exceeding \$250,000 (subject to adjustment pursuant to the CPI from and after the Ground Lease Date) for any single instance, and for such other matters as Landlord may request from time to time.

B. Contracts, Plans and Specifications. Subject to the rights of Leasehold Mortgagees and Tenant's Investor, all contracts with any architect, other design professional or any general contractor for the original construction of the Premises Improvements or the construction of Material Alterations shall provide for the assignment thereof to Landlord as security to Landlord for Tenant's performance hereunder.

C. General Construction Standards. Except as otherwise expressly provided in this Ground Lease, all Tenant construction contractors and subcontractors shall be licensed. Tenant shall require any general contractor to institute an appropriate safety program to assure the safety and convenience of all persons. In addition, Tenant shall pay (or cause to be paid) all costs and expenses associated with Tenant's work and shall indemnify, defend and hold Landlord harmless from all liabilities, damages, losses or claims attributable to the Tenant's construction of the Premises Improvements, or of any subsequent Alterations on or about the Premises, as the case may be, and the performance of Tenant's work. Dust, noise and other effects of Tenant's work shall be controlled by Tenant as required by the applicable conditions of approval of the Premises Improvements and applicable Laws so as to minimize deleterious effects associated with construction projects in a populated or developed area. Tenant shall identify an individual representative to address any neighborhood complaints related to its construction work and Tenant shall respond promptly to any neighborhood complaints. Tenant shall be required, at Tenant's expense, to obtain any and all air quality and other permits required of Tenant in connection with Tenant's construction.

D. Public Safety. Without limiting the generality of the Subsection 5.7C above, as between Landlord and Tenant, Tenant shall have the sole responsibility for implementing all necessary safeguards for the protection of workers and the public.

E. Permits. To the extent that any Premises Improvements or Alterations require a building permit or other permits from the City of Berkeley and/or any other governmental agency, Tenant shall not perform any Alterations until Tenant has obtained all requisite permits.

F. Prevailing Wage Laws. Tenant shall comply with all prevailing wage requirements of California Labor Code Sections 1720 et seq. Tenant agrees that to the extent it is required to comply with the prevailing wage requirements, Tenant shall assure that all workers are paid the general prevailing rate of per diem wages and the general per diem prevailing rate for holiday and overtime work as defined by applicable Laws (including without limitation Labor Code Section 1773.1) in effect from time to time. Copies of the applicable prevailing rate of per diem wages are on file at Landlord's principal office and will be made available to any interested party on request. Tenant agrees to post a copy of the prevailing rate of per diem wages at the Premises. Tenant, as a penalty, shall forfeit the amount then-specified by applicable Law for each calendar day, or portion thereof (or such other sum as specified from time to time by Section 1775 of the California Labor Code or other applicable law), for each worker paid less than the applicable prevailing rates for such work or craft in which such worker is employed. Unless otherwise specified by Law, the difference between such prevailing wage rates and the amount paid to each worker for each calendar day or portion thereof for which each worker was paid less than the prevailing wage rate shall be paid to each worker by Tenant.

G. Compliance With JDA and Developer Agreement. During the initial construction of the Project, Tenant shall comply with its obligations under the JDA and Developer Agreement.

H. Insurance. See ARTICLE 9 below.

I. Utility Work. Any work performed by or on behalf of Tenant or any occupant or subtenant to connect to, repair, relocate, maintain or install any storm drain, sanitary sewer, water line, gas line, telephone conduit or any other public utility service shall be performed so as to minimize interference with the provision of such services to other property owners and occupants.

**5.8 Protection of Landlord**. Landlord shall have the right at all reasonable times to post, and keep posted, on the Premises and Premises Improvements any notices which Landlord may reasonably deem necessary for the protection of Landlord and of the Premises and Premises Improvements from mechanics' liens or other claims. Tenant shall give Landlord 10 days' prior written notice of the commencement of any Alterations that could give rise to mechanics' liens to be done on or about the Premises or Premises Improvements to enable Landlord to post such notices. In addition, Landlord may in its discretion require Tenant to furnish to Landlord at Tenant's expense reasonable improvement security, including performance and labor and materials bonds, prior to commencement of any Material Alterations. Tenant shall make, or cause to be made, prompt payment of all monies due and legally owing to all persons doing any Alterations or furnishing any materials or supplies to Tenant or any of its contractors or subcontractors in connection therewith.

**5.9 Liens and Stop Notices**. Tenant shall keep the Premises and Premises Improvements free and clear of all stop notices, mechanics' liens and other liens on account of any Alterations done for Tenant or persons claiming under it. Tenant shall indemnify and save Landlord harmless against liability, loss, damages, costs, attorneys' fees, and all other expenses on account of claims of lien of laborers or materialmen or others for Alterations performed or materials or supplies furnished to Tenant or persons claiming under it. If a claim of a lien or stop notice is given or recorded affecting the Premises or Premises Improvements, Tenant shall have the right to consent the lien. Tenant shall, within 30 days of recording of a lien or service of a stop notice:

- A. Pay and discharge the same;
- B. Affect the release thereof by recording and delivering to Landlord a lien release bond in customary form and amount which results in the removal of such lien from the Premises and Premises Improvements; or
- C. Otherwise obtain or effect the release thereof.

**5.10 Notice**. Should any claims of lien be filed against the Premises or Premises Improvements thereon, or any action be commenced affecting the title to such property, the party receiving notice of such lien or action shall forthwith give the other party written notice thereof.

**5.11 Miscellaneous**.

A. Landlord Access. Representatives of Landlord shall have the right of reasonable access to the Premises upon reasonable notice to Tenant and without charges or fees, and at normal construction hours during any construction period, for the purposes of ascertaining compliance with the terms of this Ground Lease. Landlord's access shall be reasonably exercised to minimize interference with Tenant's construction and/or operations. In

any site visits, Landlord shall comply with all safety rules of the Tenant and (except as otherwise permitted in connection with its exercise of rights under Section 6.8 below) Tenant shall have the right to accompany Landlord.

B. Guarantee of Workmanship and Materials. Tenant shall insure that any transferable warranties then in effect are transferred to Landlord upon expiration or termination of this Ground Lease.

C. Notice of Completion. Promptly upon completion of construction of the Premises Improvements and Material Alterations, Tenant shall file or cause to be filed in the Official Records of the County a Notice of Completion (the “**Notice of Completion**”), and provide a filed copy to Landlord.

D. As Built Plans and Specifications. Within 30 days following completion of construction of any construction, changes, Alteration or repair on or about the Premises for which architectural drawings and specifications are required, Tenant shall deliver to Landlord three sets (at least one of which is on CD) of “**As Built**” drawings and specifications for such work, and copies of lien waivers from all contractors, subcontractors, suppliers and materialmen involved in construction.

E. Except as otherwise expressly provided in this Ground Lease or other agreement expressly referenced herein, all Premises Improvements and Alterations shall be without cost or expense to Landlord.

## **ARTICLE 6. USE OF PREMISES, COMPLIANCE WITH LAWS**

**6.1 General.** Tenant covenants and agrees on behalf of itself and its successors and assigns that Tenant shall continuously use and operate the Premises and Premises Improvements for the Permitted Use and for no other purpose without Landlord’s prior written consent, which consent Landlord may withhold in its sole discretion. As a material condition of this Ground Lease and the City Financing Documents, Tenant shall comply and shall at all times be in compliance with the Ground Lease, the Site REA, the Hope Center REA and all Regulatory Requirements. Tenant acknowledges that Landlord has entered into this Ground Lease and has agreed to the Rent structure contained herein in material reliance on Tenant’s agreement to permit only those uses described herein. In the event Tenant requests a change in any use described herein, Tenant agrees that Landlord, in its sole discretion, may withhold consent to such a request or that Landlord properly may condition consent to any change in use on a renegotiation of the Rent structure or amounts. Further, Tenant acknowledges that Landlord has determined that this use is beneficial to Landlord’s overall governmental purposes and Tenant understands that, Landlord has no obligation to consent to any other use of all or any part of the Premises.

**6.2 Governmental Requirements.** Tenant, at Tenant’s expense, shall comply with all applicable Hazardous Materials Laws (as defined in Section 7.2 below), statutes, laws, codes, rules, orders, zoning, ordinances, directions, regulations, permits, or other requirements of federal, state, county, municipal, or other governmental authorities having jurisdiction, now in force or which may hereafter be in force (individually “**Law**” and collectively “**Laws**”), which shall impose any duty upon Landlord or Tenant with respect to the use, occupancy, or alteration of the Premises or Premises Improvements or any portion thereof, including those requiring alterations or additions to be made to, or safety appliances or devices

to be maintained or installed in, on or about the Premises or Premises Improvements or any portion thereof, and payment of any fees, charges or assessments arising out of or in any way related to the Premises or Premises Improvements or any portion thereof as a source of adverse environmental impacts or effects].

**6.3 Tenant's Right to Contest.** Tenant, at its sole cost and expense, shall have the right to contest, by appropriate proceedings diligently conducted in good faith in the name of Tenant, the validity or application of any applicable Law. If compliance with any applicable Law legally may be delayed pending the prosecution of any such proceeding without cost or penalty and without subjecting Landlord to any liability, civil or criminal, Tenant may delay compliance until the final determination of such proceeding.

**6.4 Nuisance.** Tenant shall not use the Premises or the Premises Improvements for any unlawful purpose and shall not perform, permit or suffer any act of omission or commission upon or about the Premises or the Premises Improvements which would result in a nuisance or a violation of the laws and ordinances of the United States, State, County or City ordinances and all agencies thereof as the same may be now or hereafter in force and effect. Landlord understands and agrees that Tenant's residential subtenants or clients may populate and congregate on the sidewalk adjacent to or near the Premises, and may make noise when arriving at or waiting to enter the Premises Improvements. Whether or not any otherwise legal activities of the Tenant's subtenants and clients constitute a legal nuisance, they will not constitute a default justifying termination of this Lease under ARTICLE 13.

**6.5 General Use Prohibitions.** Tenant covenants and agrees that in connection with the use and operation of the Premises and Premises Improvements, and any portion thereof, Tenant will not:

- A. Permit undue accumulations of garbage, trash, rubbish or any other refuse;
- B. Create, cause, maintain or permit any nuisance (as the same may be defined by Law) in, on or about the Premises or Premises Improvements;
- C. Commit or suffer to be committed any waste in, on or about the Premises or Premises Improvements;
- D. Use or allow the Premises or Premises Improvements to be used for any unlawful purpose, or for any purpose which violates the terms of any recorded instrument affecting the Premises;
- E. Cause or permit any insurance coverage on the Premises or Premises Improvements to become void or voidable or make it impossible to obtain any required insurance at commercially reasonable rates;
- F. Intentionally cause or knowingly permit any material structural damage to or deterioration of the Premises or Premises Improvements or to any adjacent public or private property or improvements; or
- G. Violate or permit any violation of any applicable Law, ordinance or regulation applicable to the Premises or Premises Improvements.

**6.6 Non-Discrimination.** Tenant covenants and agrees that there shall be no unlawful discrimination against or segregation of any person or group of persons on account of race, color, creed, religion, sex, marital status, sexual orientation, source of income, age, physical or mental handicap, medical condition, national origin or ancestry in the sublease, transfer, use, occupancy, tenure or enjoyment of the Premises, the Premises Improvements or any portion thereof, nor shall Tenant, or any person claiming under or through Tenant, establish or permit any such unlawful practice or practices of discrimination or unlawful segregation with reference to the selection, location, number, use or occupancy of tenants, lessees, sublessees, subtenants, vendees, users or customers in the Premises, the Premises Improvements, or any portion thereof. Tenant shall refrain from unlawfully restricting the use, occupancy, rental or sublease of the Premises, the Premises Improvements, or any portion thereof on account of race, color, creed, religion, sex, marital status, sexual orientation, source of income, age, physical or mental handicap, medical condition, national origin or ancestry of any person.

**6.7 General Standards of Maintenance.** Tenant covenants and agrees that it shall maintain, or cause to be maintained, the Premises, the Premises Improvements, and all improvements and landscaping within the Premises in a good, safe condition and repair, subject only to normal wear and tear, and in full compliance with Site REA, the Hope Center REA all applicable Laws, and this Ground Lease.. To accomplish such maintenance, Tenant shall either staff or contract with and hire licensed and qualified personnel to perform such maintenance work, including the provision of labor, equipment, materials, support facilities, and any and all other items necessary to comply with the requirements of this Section. All maintenance work shall conform to all applicable Federal and State Occupation Safety and Health Act standards and regulations for the performance of maintenance.

**6.8 Landlord's Status as a Landowner.** Tenant understands and agrees that Landlord is entering into this Ground Lease in its capacity as a landowner with a proprietary interest in the Premises and Premises Improvements and not as a regulatory authority with certain police powers. Landlord's legal status shall in no way limit the obligation of Tenant to obtain any required approvals from Landlord's departments, boards or commissions that have jurisdiction over the Premises or Premises Improvements. By Landlord's entering into this Ground Lease, neither Landlord nor any of Landlord's Council, boards, commissions, agencies, departments, or affiliates obligates itself to any other governmental agent, board, commission or agency, or to Tenant, or to any other individual or entity, with regard to any discretionary action relating to development or operation of the Premises, or Premises Improvements. Discretionary action includes but is not limited to rezonings, variances, environmental clearances, or any other governmental agency approvals that may be required or desirable for the improvement, alteration, or operation of the Premises, or Premises Improvements by the City in connection with its governmental capacity or police powers. By entering into this Ground Lease, Landlord is in no way modifying or limiting the obligation of Tenant to cause the Premises and Premises Improvements to be used and occupied in accordance with all Laws, nor any right of the Landlord or its Council, boards, commissions, agencies, departments, or affiliates to directly enforce Tenant's compliance with Laws. Further, nothing in this Ground Lease shall subject Landlord to liability or increase its liability in connection with any act, omission, occurrence or circumstance arising from its governmental capacity or police powers due to its status as Landlord under this Ground Lease.

**6.9 Regulatory Approvals Generally.** Tenant acknowledges and agrees that this Ground Lease does not guarantee that Landlord, in its regulatory capacity, will grant any particular request for a license, permit or other regulatory approval. Tenant understands that

Landlord may grant or deny such request in its sole discretion, and may impose such terms and conditions as it deems consistent with that discretion and applicable Laws.

**ARTICLE 7.**

**CONDITION OF PREMISES; HAZARDOUS MATERIALS; LANDLORD'S RIGHT OF ENTRY**

**7.1 Landlord's Disclaimers and Tenant's Acknowledgements.** The Premises are being leased to Tenant in their current, existing, "AS-IS" condition as set forth in, and subject to, DDA Section 4.5, the terms of which are incorporated herein by reference, except that all references therein to "Developer" are replaced with "Tenant".

**7.2 Hazardous Materials**

A. General Compliance. DDA Section 6.2, the terms of which are incorporated herein by reference, with the following modifications in addition to the other modifications therein:

1. All references therein to "Developer" are replaced with "Tenant";
2. All references to "Hazardous Materials Laws" shall mean all laws, codes, rules, orders, ordinances, directives, regulations, permits, or other requirements of federal, state, county, municipal or governmental authorities having jurisdiction, now in force or which may hereafter be in force concerning the management, use, generation, storage, transportation, presence, discharge or disposal of any and all pollutants, wastes, flammables, explosives, radioactive materials, hazardous or toxic materials, hazardous or toxic wastes, hazardous or toxic substances, carcinogenic materials or contaminants and all other materials governed, monitored, or regulated by any Federal, State or local law or regulation, including but not limited to the Comprehensive Environmental Response, Compensation and Liability Act, the Hazardous Substances Account Act, and/or the Resources Conservation and Recovery Act.
3. All references to "**Hazardous Materials**" shall include asbestos, asbestos-containing materials, hydrocarbons, polychlorinated biphenyl ("**PCB**") or PCB-containing materials, petroleum, gasoline, petroleum products, crude oil or any fraction, product or by-product thereof.
4. All references to "Development" means the "Premises."
5. All references to "Term" shall mean "Term" as defined in this Ground Lease.
6. Nothing in this Ground Lease or **Exhibit C** shall limit or restrict the use of limited quantities of household cleaning products and office supplies used or stored at the Premises and required in connection with the routine operation and maintenance of the Premises, and used in compliance with (i) this Ground Lease, (ii) all applicable Hazardous Materials Laws, and (if applicable) (ii) the Project Rules (as defined in the Site REA) and the Hope Center Project Rules (as defined in the Hope Center REA).

B. Tenant's Independent Investigation. Tenant or its agents and representatives have undertaken investigations of the Premises in an attempt to determine if any Hazardous Material is present on the Premises. Except as disclosed in the Phase I and Phase II Environmental Assessment report dated \_\_\_\_\_, 2018 by Rincon Consultants,



and *[insert name/other information regarding additional soils testing, expected to be completed on or about December 2019]*, no Hazardous Material has been located or discovered to date and the parties agree that for purposes of this Ground Lease, Tenant assumes full responsibility for the investigation and remediation, as and to the extent required by Environmental Laws, of all Hazardous Material in, on or under the Premises that is discovered during the Term.

**7.3 Landlord's Right to Enter Premises and Premises Improvements.**

Landlord and its authorized representatives shall have the right to enter the Premises and Premises Improvements at all reasonable times, after giving Tenant 24 hours prior written notice (except in emergency in which case no notice shall be required), for any purpose, including: to determine whether the Premises, the Premises Improvements, or any other improvements on the Premises is in good condition and whether Tenant is complying with its obligations under this Ground Lease; to do any necessary maintenance and to make any restoration to the Premises Improvements or any other improvements upon the Premises that Landlord has the right or obligation to perform; to serve, post or keep posted any notices required or allowed under the provisions of this Ground Lease and (except as otherwise permitted in connection with its exercise of rights under Section 6.8 above) Tenant shall have the right to accompany Landlord.

A. Landlord shall not be liable in any manner for any inconvenience, disturbance, loss of business, nuisance, or other damage arising out of Landlord's entry on the Premises and Premises Improvements as provided in this Section other than any property damage, bodily injury, or death caused by the sole active negligence or willful misconduct of Landlord, its agents, employees or contractors.

B. Tenant shall not be entitled to an abatement or reduction of Rent if Landlord exercises any rights reserved in this section.

**ARTICLE 8.  
OWNERSHIP OF IMPROVEMENTS AND  
PERSONAL PROPERTY**

**8.1 Ownership of Premises Improvements During Term.** During the Term, the Premises Improvements and Alterations shall be and remain the property of Tenant; provided that Tenant's rights and powers with respect to the Premises Improvements and any Alterations shall be and shall remain subject to the terms and limitations of this Ground Lease. Tenant covenants for itself and all persons claiming under or through it that the Premises Improvements is and will at all times be real property.

**8.2 Ownership of Premises Improvements at Termination or Expiration.** Upon the expiration or other termination of this Ground Lease, all improvements on the Premises, including the Premises Improvements and any Alterations shall, without compensation to Tenant, become Landlord's property free and clear of all claims to the extent caused by Tenant or any subtenant. Tenant is not obligated to remove rights arising from the Site REA and Hope Center REA. The foregoing, however, will be subject to the rights of permitted subtenants at the Premises Improvements provided that the subtenants are not then in default and they attorn to Landlord as their landlord. (See also Section 15.10.)

**8.3 Removal and Ownership of Personal Property at Termination or Expiration.** At the expiration or termination of the Term, Landlord may, at Landlord's election,

require Tenant to remove from the Premises, at Tenant's sole cost and expense, all personal property (including fixtures). Tenant shall be liable to Landlord for costs incurred by Landlord in effecting the removal of such personal property (including fixtures) which Tenant has failed to remove after demand pursuant to this section.

A. Tenant and its subtenants and other permitted occupants may, from time to time during the Term, remove any personal property (other than fixtures) that may be removed without damage to the structural integrity of the Premises or Premises Improvements. Tenant shall (or shall cause its subtenants and other permitted occupants to) repair all damage caused by any such removal.

B. Any personal property owned by Tenant or its subtenants and not removed by Tenant prior to the expiration or termination of the Term shall be deemed to be abandoned by Tenant or (to the greatest extent permitted by applicable Law) its subtenants, and shall, without compensation to Tenant or (to the extent permitted by applicable Law) subtenant, become the Landlord's property, free and clear of all claims to or against them by Tenant, subtenant or any other person, but subject to the rights of third party lenders and equipment lessors as to which Landlord has notice.

## **ARTICLE 9. INSURANCE AND INDEMNITY**

### **9.1 General Insurance Requirements.**

A. During the entire Term of this Ground Lease, Tenant shall provide the following forms and amounts of insurance with respect to the Premises Improvements and the Premises. Such insurance shall be primary to and not contributing with any other insurance, self-insurance, or joint self-insurance maintained by the Landlord, shall name the Landlord as an additional insured, and shall include, but not be limited to:

1. Fire and Extended Coverage Insurance as provided the Site REA or, following the expiration or termination thereof, as Landlord may reasonably specify..

2. Broad Form Commercial General Liability Insurance in an amount not less than \$2,000,000 per occurrence and umbrella/excess liability insurance in the amount of \$5,000,000, as further provided the Site REA and this ARTICLE 9 or, following the expiration or termination thereof, as Landlord may reasonably specify. The policy shall not contain any intra-insured exclusions as between insured persons or organizations, but shall include coverage for liability assumed under this Ground Lease as an "insured contract" for the performance of Tenant's indemnity obligations under this Ground Lease. The limits of this insurance shall not, however, limit the liability of Tenant nor relieve Tenant of any obligation hereunder. .

3. Comprehensive Auto Liability Insurance with limits not less than \$2,000,000 each occurrence as further provided the Site REA and this ARTICLE 9 or, following the expiration or termination thereof, as Landlord may reasonably specify.

4. Worker's Compensation Insurance, including Employer's Liability coverage, with limits not less than \$1,000,000 each accident, to the extent required by law, as may be further provided the Site REA and this ARTICLE 9 or, following the expiration or termination thereof, as Landlord may reasonably specify.

5. Leasehold Mortgagee Insurance. Any additional policy of insurance required by any lender providing permanent financing for the Premises Improvements or any Alterations.

B. Review. The liability insurance requirements may be reviewed by Landlord every five years, for the purpose of increasing (in consultation with its insurance advisors) the minimum limits of such insurance from time to time to limits which shall be reasonable and customary for similar facilities of like size and operation in accordance with generally accepted insurance industry standards, but in no event will Tenant be required to increase the amount of cumulative or single occurrence coverage for any five-year period by more than the lesser of (i) 50% and (ii) two times the CPI increase since the last increase under this Section.

C. Insurance for Construction of Premises Improvements and Alterations. Tenant's contractors and subcontractors for the Premises Improvements shall maintain all insurance required by DDA Section 6.3(b). Tenants contractors and subcontractors for any Alterations shall maintain all liability, property worker's compensation, employee and insurance as Landlord deems reasonably necessary or as otherwise provided in this Ground Lease.

D. General. All deductibles shall be declared to and subject to Landlord's approval if in excess of \$100,000 per occurrence (as increased by CPI). All commercial general liability and automobile liability policies shall name Landlord and its officers, agents, employees, and representatives (together, "**Landlord Parties**") as additional insureds. Tenant shall furnish Landlord with a certificate of insurance evidencing the required insurance coverage and a duly executed endorsement evidencing such additional insured status. The certificate shall (to the extent reasonably obtainable) contain a statement of obligation on the part of the carrier to notify Landlord of any material change, cancellation or termination of the coverage at least 30 days in advance of the effective date of any such material change, cancellation or termination; otherwise, Tenant shall provide such notice. Upon Landlord's request, Tenant shall provide certified copies of all insurance policies, including declarations pages. Coverage provided hereunder by Tenant or its contractors shall be primary insurance and shall not be contributing with any insurance, self-insurance or joint self-insurance maintained by Landlord, and the policy shall so provide. The insurance policies shall contain a waiver of subrogation for the benefit of the Landlord and other additional insureds. The required certificate and endorsements shall be furnished by Tenant to Landlord prior to the Ground Lease Date, and prior to each anniversary thereof. If Tenant or its contractors fails to purchase, renew or maintain any insurance policies required herein, Landlord shall have the right to so purchase any such insurance and the amount of any such advance by Landlord shall constitute Additional Rent under this Ground Lease.

**9.2 Indemnity.** To the greatest extent permitted by Law (including without limitation Civil Code Section 2782 if and to the extent applicable), Tenant shall protect, indemnify, defend and hold Landlord and Landlord Parties harmless from and against any and all demands, liability, claims, actions and damages to any person or property, costs and expenses, including attorneys' fees, arising out of or connected with: (i) a default by Tenant of its obligations under this Ground Lease; (ii) the use or occupancy of the Premises Improvements, the Premises, the improvements thereon including any Alterations, or any portion thereof, by Tenant or any of its contractors, subcontractors, employees, subtenants, licensees, invitees, subtenants, assignees or Users (collectively "**Tenant's Parties**"), other than those attributable to the sole negligence or willful misconduct of Landlord or Landlord Parties; (iii) any pre-Ground Lease Date entry by or on behalf of Developer or Tenant under the Temporary Right of Entry described in DDA Section 9.19(a); and (iv) the release, use,

generation, discharge, storage or disposal of any Hazardous Materials on, under, in or about, or the transportation of any such Hazardous Materials to or from, the Premises in violation, or alleged violation, of any Laws, which occurs at any time during the Term. The indemnity obligation in clause (iii) above shall include any demands, liability, claims or actions for tangible or intangible property damage; compensation for lost wages, business income, profits or other economic loss; damage to the natural resource or the environment; nuisance; trespass; and/or contamination, leak, spill, release or other adverse effect on the environment. Tenant's indemnity obligations under this Section shall survive the expiration or termination of this Ground Lease.

**ARTICLE 10.  
DAMAGE OR DESTRUCTION**

**10.1 Restoration.**

A. Insured Damage. No loss or damage by fire or any other cause resulting in either partial or total destruction of the Premises Improvements or any other improvements now or hereafter located on the Premises, including any fixtures, personal property, equipment or machinery used or intended to be used in connection with the Premises or Premises Improvements, shall (except as otherwise provided in Sections 1.1A or 10.1B) operate to terminate this Ground Lease or to relieve or discharge Tenant from the payment of any Rent, or other amounts payable hereunder, as and when they become due and payable, or from the performance and observance of any of the agreements, covenants and conditions herein contained to be performed and observed by Tenant. Provided that Tenant determines that it is feasible to repair the Premises Improvements, and subject to the rights of Leasehold Mortgagees and Tenant's Investors, and specific procedures (if any) set forth in the Site REA, Tenant covenants to repair, reconstruct, and/or replace or cause to be repaired, reconstructed and/or replaced the Premises Improvements and any other improvements now or hereafter located on the Premises, including any fixtures, personal property, equipment or machinery used or intended to be used in connection with the Premises or Premises Improvements, so damaged or destroyed. Subject to the rights of any Leasehold Mortgagee, Tenant also covenants that all insurance proceeds will be applied to the repair, reconstruction and/or replacement described herein.

B. Premises Improvements Uninsured Damage. Notwithstanding the provisions of Section 10.1A, if, during the Term, the Premises Improvements are totally destroyed or rendered inaccessible or if the remaining portion of the Premises Improvements are rendered unsuitable (as defined herein) for Tenant's continued use, from a risk not covered 90% by the insurance required to be carried by Tenant under this Ground Lease, and either (i) the cost of restoration exceeds 50% of the then replacement value of the Premises Improvements as reasonably determined by Landlord, (ii) Tenant reasonably determines that repair and reconstruction is infeasible, or (iii) or if fewer than fifteen (15) years of the Term remain, Tenant can elect to terminate this Ground Lease by giving notice to Landlord within 30 days after Landlord's determination of the restoration cost and replacement value. The Premises Improvements shall be deemed unsuitable for Tenant's continued use if, following a reasonable amount of reconstruction, Tenant's operations in the Premises Improvements could not be maintained at an economically feasible level. Subject to the rights of Leasehold Mortgagees and Tenant's Investors, if this Ground Lease terminates pursuant to this Section, Tenant shall surrender possession of the Premises and, subject to the rights of Leasehold Mortgagees and Tenant's Investors, assign to Landlord its rights and interests in and to the proceed of insurance received by Tenant for the repair or demolition of the Premises Improvements.

C. Loss Adjustment and Disbursement Procedures. Except as may otherwise be required by any Leasehold Mortgagee, Tenant shall make the loss adjustment with the insurance company insuring the loss. Except as may otherwise be required by any Leasehold Mortgagee and Tenant's Investors, all resulting insurance proceeds shall be held for the following purposes:

1. The sums shall be paid in installments by the contractor retained by Tenant as construction progresses, for payment of the cost of restoration. Any final retention provided for in the contract with such contractor will be paid to the contractor on completion of restoration, payment of all costs, expiration of all applicable lien periods, and proof that the restored Improvements and the Premises are free of all mechanics' liens and lienable claims.

2. Payments shall be made on presentation of certificates or vouchers from the architect or engineer retained by Tenant showing the amount due. If Landlord, in its reasonable discretion, determines that the certificates or vouchers are being improperly approved by the architect or engineer retained by Tenant, Landlord shall have the right to appoint a project manager to supervise construction and to approve payments on certificates or vouchers approved by the architect or engineer retained by the Tenant. The reasonable expenses and charges of the project manager retained by Landlord shall be paid from the insurance proceeds.

3. If at any time it reasonably appears to Tenant that the sums held by the Tenant are not sufficient to pay the actual cost of restoration, Tenant shall identify the amount of the deficiency to Landlord as promptly thereafter as reasonably possible.

4. Any undisbursed funds after compliance with the provisions of this Section 10.1C shall be delivered to Landlord to the extent of Landlord's contribution to the fund, and the balance, if any, shall be paid to Tenant.

**10.2 Waiver.** The provisions of this ARTICLE 10 shall govern the rights of the parties in the event of any full or partial destruction of the Premises Improvements and any improvements thereon. Tenant hereby waives the provisions of Civil Code Section 1932(2) and Civil Code Section 1933(4) and any similar successor statute or Law with respect to any destruction of the Premises Improvements.

**10.3 Determination of Extent of Destruction, Interference with Use.** For purposes of this ARTICLE 10, the extent of destruction of the Premises Improvements shall be determined by dividing the estimated cost of replacement or restoration as evidenced by estimates prepared by licensed general contractors acceptable to Landlord for the full replacement cost of the Premises Improvements, as reasonably determined by Landlord, Tenant and (to the extent required by the applicable insurance policies) Tenant's insurers.

**10.4 Procedures for Repair and Restoration.** Tenant shall promptly give Landlord reasonable written notice in the event of any damage or destruction to either (i) the Premises Improvements or (ii) (to the extent of Tenant's actual knowledge) the entire Development, with an estimated restoration cost exceeding \$1,000,000 (subject to adjustment pursuant to the CPI from and after the Ground Lease Date). Tenant's notice shall include the general nature of the damage or destruction and the date on which it occurred. Regardless of the amount of any damage or destruction, Tenant shall promptly make proof of loss and shall proceed promptly to collect, or cause to be collected, all valid claims which Tenant may have against insurers or others based upon any such damage or destruction. Except as otherwise

provided above and subject to rights of Leasehold Mortgagees and Investors, amounts received on account of any losses pursuant to insurance policies shall be used and expended for the purpose of fully repairing or reconstructing the portions of the Premises Improvements which have been destroyed or damaged (or repaying loans or advances used for such purposes).. Tenant shall commence and complete or cause to be commenced and completed any repairs and reconstruction in a good and workmanlike manner and in accordance with the Site REA, this ARTICLE 10 and the applicable provisions of ARTICLE 5 above.

## ARTICLE 11. CONDEMNATION

### 11.1 Definitions.

A. “**Condemnation**” means: (1) the exercise of any governmental power in eminent domain, whether by legal proceedings or otherwise, by a condemnor, and (2) a voluntary sale or transfer to any condemnor, either under threat of condemnation or while legal proceedings for condemnation are pending.

B. “**Date of taking**” means the date the condemnor has the right to possession of the property being condemned.

C. “**Award**” means all compensation, sums or anything of value awarded, paid or received on a total or partial condemnation.

D. “**Condemnor**” means any public or quasi-public authority, or private corporation or individual, having the power of condemnation.

**11.2 Parties’ Rights and Obligations to be Governed by Ground Lease.** If during the Term there is any taking of all or any part of the Premises, the Premises Improvements or any other improvements on the Premises or any interest in this Ground Lease by condemnation, the rights and obligations of the parties shall be determined pursuant to the provisions of this ARTICLE 11.

**11.3 Total Taking.** If the Premises or Premises Improvements are totally taken by condemnation, this Ground Lease shall terminate on the date of taking.

**11.4 Effect of Partial Taking.** If a portion of the Premises Improvements or Premises or any other improvements thereon are taken by condemnation, this Ground Lease shall remain in effect, except that Tenant may elect to terminate this Ground Lease if the remaining portion of the Premises or Premises Improvements are rendered unsuitable (as defined herein) for Tenant’s continued use. The remaining portion of the Premises Improvements or the Premises shall be deemed unsuitable for Tenant’s continued use if, following a reasonable amount of reconstruction, Tenant’s operations in the Premises Improvements could not be maintained at an economically feasible level. Tenant must exercise its right to terminate by giving Landlord written notice of its election within 90 days after the nature and extent of the taking have been finally determined. Such notice shall also specify the date of termination, which shall not be prior to the date of taking. Failure to properly exercise the election provided for in this Section 11.4 will result in this Ground Lease continuing in full force and effect.

**11.5 Restoration of Premises Improvements.** If in Tenant's judgment it is reasonably possible and economically feasible to do so, Tenant shall be entitled to use that portion of the award allocable to the Premises Improvements as is necessary to restore or to add on to the Premises Improvements so that the area and approximate layout of the Premises Improvements will be substantially the same after the date of taking as it was before the date of taking. If it is not reasonably possible and economically feasible to so restore the area and layout of the Premises Improvements, the remaining provisions of this ARTICLE 11 shall govern the rights of the parties. If Tenant fails to promptly commence any reasonably required repair, restoration or reconstruction of the Premises Improvements and diligently prosecute such repair, restoration or reconstruction to completion, and such failure is not remedied within 30 days of written notice from the Landlord to Tenant, this Ground Lease may be terminated by the Landlord.

**11.6 Waiver of CCP Section 1265.130.** Each party waives the provisions of the Code of Civil Procedure Section 1265.130 allowing either party to petition the Superior Court of the County of Alameda, State of California to terminate this Ground Lease in the event of a partial taking of the Premises.

**11.7 Award.** Subject to the provisions of Section 11.5, and subject to the rights of Leasehold Mortgagees and Investors, if all or any portion of the Premises Improvements or any other improvements on the Premises is taken in connection with a condemnation, the award for the Premises Improvements or such other improvements shall be allocated taking into account that the Landlord's interest is limited to the land or air space (exclusive of the Premises Improvements). If the Premises Improvements are to be restored pursuant to Section 11.5 above, Tenant shall be entitled to recover the costs and expense incurred in such restoration out of any condemnation proceeds. Thereafter, if the condemning authority does not make separate awards, the proceeds will be allocated on a proportionate basis. If Landlord and Tenant are unable to agree as to the amounts that are to be allocated to each other, the allocation will be determined by an appraisal performed by a mutually agreed appraiser. The appraiser shall separately determine the amount of award to be allocated to the interest of each party, and the costs of the appraiser shall be borne equally by each party.

## **ARTICLE 12. ASSIGNMENT AND SUBLETTING**

### **12.1 Assignment.**

A. Tenant shall not assign, sublet or otherwise transfer, whether voluntarily or involuntarily or by operation of Law, this Ground Lease, the Premises Improvements or any part thereof (collectively an "**assignment**") without Landlord's written consent, which shall not unreasonably be withheld, conditioned or delayed. The merger of Tenant with any other entity or the assignment or transfer of any direct or indirect controlling or managing ownership interest in Tenant, or the assignment or transfer of a substantial portion of the assets of Tenant, whether or not located at the Premises, or any interest in the Premises Improvements, shall constitute an "assignment" hereunder. However, the transfer of a limited partnership interest in a limited partnership tenant, or of a non-managing membership interest in a limited liability company tenant, shall not constitute an assignment. Further, any Developer's departure from Tenant (or Tenant's general partner or managing member) requires Landlord's written consent, which shall not be unreasonably withheld, conditioned, or delayed.

B. Notwithstanding Subsection 12.1A above, Landlord's consent is not required for any assignment to an Affiliate (as defined below) of BRIDGE or BFHP, as long as the following conditions are met: (i) Landlord receives written notice of the assignment (as well as any documents or information reasonably requested by Landlord regarding the assignment or assignee); and (ii) the assignee assumes in writing all of Tenant's obligations under this Ground Lease. For purposes of this Section, "**Affiliate**" means an entity which controls, is controlled by or under common control with Tenant. For the purposes of this definition, "control" means the direct or indirect ownership of more than 50% of the voting securities of an entity or possession of the right to direct the entity's day-to-day affairs.

C. Also notwithstanding Subsection 12.1A above, Landlord's consent is not required for any assignment to an Investor, as long as the following conditions are met: (i) the assignment occurs pursuant to the term of Tenant's governing documents, following a default to the Investor; (ii) Landlord receives written notice of the assignment (as well as any documents or information reasonably requested by Landlord regarding the assignment or assignee); and (iii) the Investor assumes in writing all of Tenant's obligations under this Ground Lease.

D. No partial assignments of this Ground Lease shall be permitted, and all assignments must be accompanied by a concurrent transfer of the Premises Improvements to the assignee. Assignments of this Ground Lease shall only be made pursuant to a written assignment and assumption agreement in a form reasonably acceptable to Landlord. Landlord's consent to any one assignment shall not constitute consent to any other assignment, and shall not constitute a waiver of the right to give or withhold consent in accordance with this Section 12.1.

E. In the event Tenant shall assign this Ground Lease or request the consent of Landlord to any assignment for which Landlord's consent is required under this ARTICLE 12, then Tenant shall pay Landlord's reasonable attorneys' fees incurred in connection with each such request.

**12.2 Subleases.** Except to residential tenants and other tenants typically entered into in connection with residential development (such as laundry leases) and subject to all Regulatory Requirements, Tenant shall not sublease all or any portion of the Premises Improvements or the Premises without Landlord's prior written consent, which may be withheld for any reason whatsoever in Landlord's sole absolute discretion. No permitted subletting shall limit Tenant's obligations under this Lease.

## **ARTICLE 13. TENANT DEFAULTS AND LANDLORD'S REMEDIES**

**13.1 Defaults by Tenant.** Tenant shall be in default under this Ground Lease upon occurrence of any of the following:

A. Tenant shall at any time be in default in the payment of Rent or any other monetary sum called for by this Ground Lease for more than 30 days following written notice from Landlord to Tenant; or

B. Tenant shall at any time be in default in the keeping and performing any of its covenants or agreements contained in the Regulatory Requirements, Site REA or Hope Center REA, and such other default continues for 30 days after written notice thereof from Landlord to Tenant specifying the particulars of such default, or if such default is of a nature that



curing such default will take more than 30 days Tenant has failed to commence such cure within such 30-day period and to thereafter diligently and continuously pursue completion of such cure, provided that such cure period need not exceed any time period that the failure to cure would result in Landlord itself being in violation of any Law or expose Landlord to unreasonable financial risks; or

C. Tenant shall at any time be in default in the keeping and performing of any of its other covenants or agreements contained in this Ground Lease, and should such other default continue for 30 days after written notice thereof from Landlord to Tenant specifying the particulars of such default, or if such other default is of a nature that curing such default will take more than 30 days Tenant has failed to commence such cure within such 30-day period and to thereafter diligently and continuously pursue completion of such cure; or

D. Tenant abandons or substantially suspends the Premises Improvements prior to completion thereof and such default is not cured within 60 days of written notice from Landlord to Tenant; or

E. Tenant assigns, sells, transfers, conveys, encumbers, hypothecates or leases the whole or any part of the Premises Improvements, the Premises, or any other improvement constructed thereon in violation of the Improvements Documents; or

F. Except as otherwise expressly permitted in this Ground Lease there is any change in control of Tenant, or any other act or transaction involving or resulting in a change in the identity of the parties in control of Tenant or the degree of such control; or

G. Subject to ARTICLE 14 below, Tenant defaults on any loan encumbering Tenant's interest in this Ground Lease or any improvements on the Premises for which Tenant is responsible, and such failure continues beyond (i) the expiration of any applicable grace or cure period, and (ii) the date by which Tenant must make payment to cure any notice of default received from the holder of such loan; or

H. Any Leasehold Mortgagee or any other holder of any private loan encumbering Tenant's interest in this Ground Lease, or any improvements on the Premises initiates a foreclosure of the deed of trust by which such loan is secured, and Tenant fails to cause such foreclosure proceedings to be dismissed prior to the earlier to occur of (i) the trustee under the deed of trust giving notice of the trustee's sale, or (ii) within 30 days of Tenant's receipt of written notice from Landlord.

**13.2 Remedies.** Subject to the rights of any Leasehold Mortgagees permitted under ARTICLE 14, upon the occurrence of any such default, in addition to any and all other rights or remedies of Landlord hereunder, or by Law or in equity provided, Landlord shall have the sole option to exercise the following rights and remedies:

A. Terminate this Ground Lease by giving Tenant notice of termination. On the giving of such notice, all of Tenant's rights in the Premises, Premises Improvements and any other improvements located thereon, shall terminate. Immediately following notice of termination, Tenant shall surrender and vacate the Premises, including the Premises Improvements and any other improvements located thereon, leaving them in broom-clean condition; and, subject to Subsection 13.2B below, respecting the right of certain subtenants to remain, Landlord may reenter and take possession of the Premises and Premises Improvements and eject all parties in possession or eject some and not others, or eject none. Termination

under this subsection shall not relieve Tenant from the payment of any sum then due to Landlord or from any claim for damages previously accrued or then accruing against Tenant.

B. Without terminating this Ground Lease, Landlord may at any time and from time to time relet the Premises, including the Premises Improvements, or any part or parts thereof for the account and in the name of Tenant or otherwise. Any reletting may be for the remainder of the Term or for a longer or shorter period, and subject to the rights of any subtenant under subleases permitted under Section 12.2. Landlord may execute any leases made under this provision either in Landlord's name or in Tenant's name, and shall be entitled to all rents from the use, operation, and occupancy of the Premises, Premises Improvements and any other improvements thereon. Tenant hereby appoints Landlord its attorney-in-fact for purpose of such leasing. Tenant shall nevertheless pay to Landlord on the due dates specified in this Ground Lease the equivalent of all sums required of Tenant under this Ground Lease, less the revenue received by Landlord from any reletting or attornment, plus Landlord's reasonable expenses, including (by way of example), but not limited to, remodeling expenses, Landlord's brokerage and advertising costs and attorneys' fees and costs. No act by or on behalf of Landlord under this subsection shall constitute a termination of this Ground Lease unless Landlord gives Tenant written notice of termination, and Tenant shall remain liable for all costs, losses and damages resulting from unperformed Tenant obligations and breaches under permitted subleases.

C. Even though Landlord may have relet all or any portion of the Premises, including the Premises Improvements and any other improvements thereon, Landlord may thereafter elect to terminate this Ground Lease and all of Tenant's rights in or to the foregoing.

**13.3 Damages.** Neither party shall be entitled to recover consequential or punitive damages under this Lease.

**13.4 Landlord's Right to Cure Tenant's Default.** Landlord, at any time after Tenant commits a default which Tenant has failed to cure within the time established therefor, may cure the default at Tenant's cost. If Landlord at any time, by reason of Tenant's default, pays any sum, the sum paid by Landlord shall be due immediately from Tenant to Landlord at the time the sum is paid, and if paid at a later date, shall bear interest at the Interest Rate from the date the sum is paid by Landlord until Landlord is reimbursed by Tenant. The sum, together with interest thereon, shall be Additional Rent.

**13.5 Guarantor Performance Under Completion Guaranty.** Notwithstanding anything in this Ground Lease to the contrary (other than the last sentence of this Section 13.5), (i) if Landlord enforces its rights against Guarantor, Guarantor's performance in compliance with the Completion Guaranty shall be deemed to suspend any default by Tenant under this Ground Lease relating to the construction of the Premises Improvements, and Landlord shall accept Guarantor's performance thereof; and (ii) so long as the Guarantor proceeds diligently to perform the guaranteed obligations thereunder (subject to permitted force majeure delays and other delays expressly specified in the Completion Guaranty) and to cause the Premises Improvements to be completed within three years following the date completion is otherwise required under this Ground Lease, Landlord shall not exercise any of its remedies under the Ground Lease arising from the Tenant's failure to construct the Premises Improvements as required herein including, without limitation, termination of this Ground Lease. Nothing in this Section 13.5 shall limit Landlord's right to collect any amounts otherwise due under Section 13.4 following Guarantor's satisfaction of all obligations under the Completion Guaranty or Guarantor's default thereunder.

**ARTICLE 14.  
MORTGAGEE PROTECTION PROVISIONS**

**14.1 Right to Encumber.** Tenant shall have the right during the Term to encumber, through one or more Leasehold Mortgages and the Regulatory Requirements, all of Tenant's right, title and interest in the Premises, subject to the provisions of this Ground Lease; provided, however, that any Leasehold Mortgage shall be in all respects subordinate and inferior to Landlord's right, title and interest as fee title owner of the Site and Premises, and any such Leasehold Mortgagee shall be subject to all of the rights and obligations of Landlord herein contained in this Ground Lease, except as otherwise provided in this Ground Lease. For purposes of this Ground Lease, Landlord and Tenant acknowledge and agree that the Senior Leasehold Mortgagee identified on **Exhibit F** attached hereto is a permitted Leasehold Mortgagee and all references to a "Leasehold Mortgagee" shall specifically include Senior Leasehold Mortgagee. All references to a Leasehold Mortgage shall include, without limitation, that certain Construction Leasehold Deed of Trust, Security Agreement, Assignment of Leases and Rents and Fixture Filing, dated as of even date herewith, made by Tenant for the benefit of the initial Senior Leasehold Mortgagee. For so long as any Leasehold Mortgage is outstanding, Landlord shall not agree to any mutual termination or accept any surrender of this Ground Lease without the prior written consent of the holders of Leasehold Mortgages then in effect, and any such termination or surrender without such consent shall have no force or effect.

**14.2 Leasehold Mortgagee as Third Party Beneficiary.** Notwithstanding anything to the contrary contained herein, a Leasehold Mortgagee shall be deemed to be a third party beneficiary of Tenant's obligations under this Ground Lease; provided that the foregoing shall not alter any right, remedy, duty or obligation between Tenant and Landlord herein.

**14.3 Notice to Leasehold Mortgagee.** During any period in which a Leasehold Mortgage is in place, Landlord shall give any such Leasehold Mortgagee of which Landlord has received notice from Tenant a duplicate copy of all notices of default or other notices that Landlord may give to or serve in writing upon Tenant pursuant to the terms of this Ground Lease. The address of the Leasehold Mortgagee originally designated in the Leasehold Mortgage may be changed upon written notice delivered to Landlord in the manner specified in Section 15.5 below. Landlord's failure to give any such notice to any such Leasehold Mortgagee shall not render such notice ineffective, nor shall any such failure constitute a default hereunder. Landlord acknowledges the Leasehold Mortgagee identified in **Exhibit F** as a holder of a Leasehold Mortgage.

**14.4 Right of Leasehold Mortgagee to Cure.** Notwithstanding any default by Tenant under this Ground Lease, Landlord shall have no right to terminate this Ground Lease unless Landlord shall have given each Leasehold Mortgagee written notice of such default and such Leasehold Mortgagees shall have failed to remedy such default or acquire Tenant's leasehold estate created by this Ground Lease or commence foreclosure or other appropriate proceedings as set forth in, and within the time specified by, this Section 14.4.

A. Any Leasehold Mortgagee which has an outstanding Leasehold Mortgage shall have the right, but not the obligation, at any time to pay any or all of the Rent due pursuant to the terms of this Ground Lease, and do any other act or thing required of Tenant by the terms of this Ground Lease, to prevent termination of this Ground Lease. Each Leasehold Mortgagee shall have 90 days after receipt of notice from Landlord describing such default to cure the default. All payments so made and all things so done shall be as effective to prevent a

termination of this Ground Lease as the same would have been if made and performed by Tenant instead of by Leasehold Mortgagees.

B. In addition to the cure period provided in Section 14.4A above, if the default is such that possession of the Premises may be reasonably necessary to remedy the default, any Leasehold Mortgagee shall have a reasonable time after the expiration of such 90 day period within which to remedy such default, provided that (i) such Leasehold Mortgagee shall have fully cured any default in the payment of any monetary obligations of Tenant under this Ground Lease within such 90 day period and shall continue to pay currently such monetary obligations when the same are due and (ii) such Leasehold Mortgagee shall have acquired Tenant's leasehold estate hereunder or commenced foreclosure or other appropriate proceedings prior to or within such period, and shall be diligently prosecuting the same.

C. Any default under this Ground Lease which by its nature cannot be remedied by any Leasehold Mortgagee shall be deemed to be remedied if (i) within 90 days after receiving written notice from Landlord describing the default, or prior thereto, any Leasehold Mortgagee shall have acquired Tenant's leasehold estate or commenced foreclosure or other appropriate proceedings, (ii) Leasehold Mortgagee shall diligently prosecute any such proceedings to completion, (iii) Leasehold Mortgagee shall have fully cured any default in the payment of any monetary obligations of Tenant hereunder which does not require possession of the Premises, and (iv) after gaining possession of the Premises, the Leasehold Mortgagee shall cure all non-monetary defaults of Tenant hereunder capable of cure by Leasehold Mortgagee.

D. If any Leasehold Mortgagee is prohibited, stayed or enjoined by any bankruptcy, insolvency or other judicial proceedings involving Tenant from commencing or prosecuting foreclosure or other appropriate proceedings, the times specified for commencing or prosecuting such foreclosure or other proceedings shall be extended for the period of such prohibition; provided that any Leasehold Mortgagee shall have fully cured any default in the payment of any monetary obligations of Tenant under this Ground Lease and shall continue to pay currently such monetary obligations when the same fall due; provided, further, that such Leasehold Mortgagee shall not interfere with Landlord's efforts to seek compliance by the Tenant with any non-monetary obligation under this Ground Lease.

E. As used in this Section 14.4, "monetary obligations of Tenant" does not include damages, costs and expenses arising from any obligation of Tenant to indemnify Landlord for any acts or omission of Tenant prior to the date a Leasehold Mortgagee assumes the obligations of Tenant hereunder.

**14.5 Limitation on Liability of Leasehold Mortgagee.** No Leasehold Mortgagee shall be or become liable to Landlord as an assignee of this Ground Lease or otherwise unless it expressly assumes by written instrument executed by Landlord and Leasehold Mortgagee such liability (in which event the Leasehold Mortgagee's liability shall be limited to the period of time during which it is the owner of the leasehold estate created hereby) and no assumption shall be inferred from or result from foreclosure or other appropriate proceedings in the nature thereof or as the result of any other action or remedy provided for by such Leasehold Mortgagee or other instrument or from a conveyance from Tenant pursuant to which the purchaser at foreclosure or grantee shall acquire the rights and interest of Tenant under the terms of this Ground Lease.

**14.6 Estoppel Certificates.** Landlord and Tenant agree that at any time and from time to time upon not less than 20 days' prior written notice by the other party, or upon

request from any Leasehold Mortgagee or Investor or a permitted assignee, Landlord or Tenant will execute and deliver to the other party or to such Leasehold Mortgagee or Investor a statement in writing certifying (a) that this Ground Lease is unmodified and in full force and effect (or specifying any known amendments if applicable); (b) the date through which the Rents have been paid; and (c) that, to the knowledge of the certifier (if such be the case), there is no default (or any conditions existing which, but for the passage of time or the giving of notice, would constitute a default) set off, defense or other claim against Landlord or Tenant, as applicable, other than those, if any, so specified under the provisions of this Ground Lease. It is intended that any such statement may be relied upon by any persons proposing to acquire the interest of Landlord, Tenant or any Leasehold Mortgagee or Investor, as the case may be, in this Ground Lease or by any prospective Leasehold Mortgagee or Investor or permitted assignee of any Leasehold Mortgagee or Investor.

**14.7 Registration of Leasehold Mortgages.** Upon written request by Landlord, Tenant shall provide written notice to Landlord of the name and address of each Leasehold Mortgagee under this Ground Lease.

**14.8 New Ground Lease.** In the event of the termination of this Ground Lease prior to the natural expiration of the Term of this Ground Lease due to a default of Tenant or operation of law or otherwise (including, without limitation, a rejection or other termination of this Ground Lease pursuant to any bankruptcy filing by or against Tenant or the commencement of any other insolvency proceeding or similar proceeding, an act of condemnation or eminent domain against a portion of the Premises by a government agency or body, the destruction or damage of the Premises, or upon a foreclosure of Tenant's estate by a Leasehold Mortgagee or acceptance of a deed in lieu of foreclosure or a change in the control or management of Tenant in violation of this Ground Lease), Landlord shall also be obligated to give notice to Leasehold Mortgagee simultaneously under Section 14.3 hereof with such notice given to Tenant; provided that no failure to give such notice to Leasehold Mortgagee shall invalidate the termination of this Ground Lease. Landlord, upon written request from Senior Leasehold Mortgagee and at Senior Mortgagee's sole cost and expense, shall enter into a new lease with such holder or its designee in accordance with and upon the same terms and conditions as set forth in this Ground Lease. In addition, without limiting the preceding sentences, in the event of the filing of a petition in bankruptcy by or against Tenant, and the Tenant rejects this Ground Lease under the then applicable provisions of the Bankruptcy Code, Landlord shall, upon the request of a Leasehold Mortgagee and at Senior Leasehold Mortgagee or its designee's sole cost and expense, affirm this Ground Lease, and Landlord will enter into a new ground lease on the same terms and conditions set forth in this Ground Lease with such holder or its designee promptly upon Tenant's rejection of this Ground Lease. In the event of the filing of a petition in bankruptcy by the Landlord, and the Landlord rejects this Ground Lease and the Tenant does not affirm it, a Leasehold Mortgagee will have the authority to affirm this Ground Lease on behalf of the Tenant and to keep the Ground Lease in full force and effect.

A. After cancellation and termination of this Ground Lease, and upon compliance with the provisions of this Section 14.8 by Leasehold Mortgagee, or its designee, upon the request of Leasehold Mortgagee or its designee within the time provided in Section 14.4 hereof, Landlord shall, at Senior Leasehold Mortgagee or its designee's sole cost and expense, execute and deliver such new ground lease to such Leasehold Mortgagee or its designee, having the same relative priority in time and right as this Ground Lease (to the extent possible) and having the benefit of all the right, title, interest, powers and privileges, and obligations and liabilities of Tenant hereunder in and to the Premises.

**14.9 Rights of Investor.** The Investor shall have the same notice and cure rights as any Leasehold Mortgagee (including monetary obligations) as set forth in Section 14.4 for so long as it is a limited partner of Tenant; provided, however, that Investor shall be deemed to have met any condition relating to commencement or continuation of a foreclosure proceeding as set forth in Section 14.4 above, if it is attempting with diligence and in good faith to remove the general partner of Tenant. The address for any notices to Investor, as of the date hereof, is provided in Basic Lease Information Section 14.

**14.10 Transfers.** The consent of Landlord shall not be required for the mortgage of Tenant's interest in the Premises and Premises Improvements to any Leasehold Mortgagee, including, without limitation, Senior Leasehold Mortgagee, and transfer of the Premises and Premises Improvements to such Leasehold Mortgagee by foreclosure or deed-in-lieu of foreclosure (or the leasehold equivalent thereof), or to a third-party purchaser pursuant to a foreclosure sale (or the leasehold equivalent thereof); the consent of Landlord to a Transfer by a Leasehold Mortgagee after acquisition by foreclosure, at Senior Leasehold Mortgagee or its designee's sole cost and expense, will not be unreasonably withheld or delayed.

**14.11 Permitted Use Requirements.** Following a transfer of the Premises to any Leasehold Mortgagee (or its nominee or assignee), including, without limitation, Senior Leasehold Mortgagee, and transfer of the Premises and Premises Improvements to such Leasehold Mortgagee by foreclosure or deed-in-lieu of foreclosure (or the leasehold equivalent thereof), or to a third-party purchaser pursuant to a foreclosure sale (or the leasehold equivalent thereof), notwithstanding anything to the contrary in this Ground Lease, the Permitted Use of the Premises shall be affordable housing.

**14.12 Further Ground Lease Amendments.** Landlord shall cooperate in including in this Ground Lease by suitable amendment from time to time any provision which may reasonably be requested by any Leasehold Mortgagee or any proposed lender, at Leasehold Mortgagee or proposed lender's sole cost and expense, for the purpose of implementing the mortgagee-protection provisions contained in this Ground Lease and allowing such Leasehold Mortgagee or proposed lender reasonable means to protect or preserve the lien of the leasehold mortgage and the value of its security, and to include any additional rights and privileges reasonably requested to be added by such Leasehold Mortgagee. Landlord agrees to execute and deliver (and to acknowledge, if necessary, for recording purposes) any agreement necessary to effect any such amendment; provided, however, that any such amendment shall not in any way affect Landlord's fee estate in the Site or any other interest of Landlord in the Site or Premises, affect the Term or rent under this Ground Lease, or otherwise in any material respect adversely affect any rights of Landlord under this Ground Lease or (except as otherwise expressly provided herein) Regulatory Requirements.

**ARTICLE 15.  
MISCELLANEOUS**

**15.1 Holding Over.** If Tenant shall hold over in the Premises Improvements or Premises after the expiration or termination of the Term hereof with or without the consent of Landlord, such holding over shall be construed to be only a tenancy from month to month, subject to all the covenants, conditions and obligations contained in this Ground Lease. Tenant hereby agrees to pay to Landlord as monthly rental \$500 per month, plus all Additional Rent as otherwise required in this Ground Lease.

**15.2 Attorneys' Fees.** In the event that any action is brought by either party hereto against the other for the enforcement or declaration of any right or remedy in or under this Ground Lease or for the breach of any covenant or condition of this Ground Lease, the prevailing party shall be entitled to recover, and the other party agrees to pay, all fees and costs to be fixed by the court therein including, but not limited to, attorneys' fees.

**15.3 Quiet Possession.** Landlord agrees that so long as Tenant is not in default under this Ground Lease and is paying the Rent and performing all of the covenants and conditions of this Ground Lease, Tenant shall quietly have, hold and enjoy the Premises throughout the Term hereof without interruption or disturbance from Landlord or any other persons claiming by, through or under Landlord. For purposes of this Section 15.3, persons exercising their rights under the Site REA or Hope Center REA shall be deemed to a person claiming by, through or under Tenant.

**15.4 Force Majeure.** Except as to the payment of Rent, subject to the limitations set forth below, performance by either party hereunder (including without limitation continuing obligations under the DDA) shall not be deemed to be in default, and all performance and other dates specified in this Ground Lease shall be extended, where delays are due to: war; insurrection; strikes; lockouts; riots; floods; earthquakes; fires; casualties; acts of God; acts of the public enemy; epidemics; quarantine restrictions; freight embargoes; governmental restrictions or priority; unusually severe weather; lack of reasonable availability of labor or materials; acts or omissions of the other party; or acts or failures to act of the City or any other public or governmental agency or entity (other than the acts or failures to act of Landlord which shall not excuse performance by Landlord) (together, "**Force Majeure**"). An extension of time for any such cause shall be for the period of the enforced delay and shall commence to run from the time of the commencement of the cause, if notice by the party claiming such extension is sent to the other party with reasonable promptness (not more than 30 days) of the commencement of the cause. Times of performance under this Ground Lease may also be extended in writing by the mutual agreement of Landlord and Tenant. Tenant expressly agrees that post-Ground Lease Date adverse changes in economic conditions, either of Tenant specifically or the economy generally, changes in market conditions or demand, and/or Tenant's inability to obtain financing or other lack of funding, shall not constitute a Force Majeure delay pursuant to this Section 15.4. Tenant expressly assumes the risk of such adverse economic or market changes and/or financial inability, whether or not foreseeable as of the Ground Lease Date.

**15.5 Notices.** Any notice to be given or other document to be delivered by either party to the other hereunder shall be in writing and shall be deemed to have been duly given and received (i) upon personal delivery, (ii) as of the third business day after mailing by United States registered or certified mail, return receipt requested, postage prepaid, addressed as set forth below, or (iii) the immediately succeeding business day after deposit with Federal

Express or other equivalent overnight delivery system, addressed to the party for whom intended, as indicated in the Basic Ground Lease Information. Any party hereto may from time to time, by written notice to the other, designate a different address which shall be substituted for the one above specified.

**15.6 Waiver.** No waiver of any breach of any of the terms, covenants, agreements, restrictions or conditions of this Ground Lease shall be construed to be a waiver of any succeeding breach of the same or other terms, covenants, agreements, restrictions and conditions hereof.

**15.7 Surrender.** Upon the expiration or sooner termination of the Term of this Ground Lease, and notwithstanding anything herein contained to the contrary, Tenant shall surrender to Landlord the Premises Improvements, the Premises and any other improvements thereon, broom clean and in good condition and repair, reasonable wear and tear excepted.

**15.8 Binding.** Subject to the restrictions set forth herein regarding assignment of , Tenant's interest in this Ground Lease, each of the terms, covenants and conditions of this Ground Lease shall extend to and be binding on and shall inure to the benefit of not only Landlord and Tenant, but to each of their respective heirs, administrators, executors, successors and assigns. Whenever in this Ground Lease reference is made to either Landlord or Tenant, the reference shall be deemed to include, wherever applicable, the heirs, administrators, executors, successors and assigns of such parties, the same as if in every case expressed.

**15.9 Disclaimer of Partnership.** The relationship of the parties hereto is that of Landlord and Tenant, and it is expressly understood and agreed that Landlord does not in any way nor for any purpose become a partner of Tenant or a joint venturer with Tenant in the Premises Improvements or in the conduct of Tenant's business or operations or otherwise.

**15.10 Quitclaim.** At termination or expiration of the Term of this Ground Lease, Tenant shall execute, acknowledge and deliver to Landlord within 30 days, a valid and recordable quitclaim deed covering the Premises and Premises Improvements, free and clear of all monetary liens and encumbrances not caused or agreed to by Landlord ("**Quitclaim Deed**"). If Tenant fails to clear all monetary liens and encumbrances as required by this Section at termination or expiration of the Term of this Ground Lease, Tenant shall continue to be liable and responsible for all such costs, liabilities and expenses associated with, related to or caused by such encumbrances that were not removed by Tenant, and Landlord may take any and all action to enforce its rights under this Ground Lease and to have such encumbrances removed, and all costs and expenses associated with such actions shall be paid solely by Tenant upon Landlord's demand

**15.11 Interpretation.** The titles to the sections of this Ground Lease are not a part of this Ground Lease and shall have no effect upon the construction or interpretation of any part of this Ground Lease. As used in this Agreement, masculine, feminine or neuter gender and the singular or plural number shall each be deemed to include the others where and when the context so dictates. The word "including" shall be construed as if followed by the words "without limitation." This Ground Lease shall be interpreted as though prepared jointly by both parties.

**15.12 Severability.** If any term, provision, condition or covenant of this Ground Lease or its application to any party or circumstances shall be held, to any extent, invalid or



unenforceable, the remainder of this Ground Lease, or the application of the term, provision, condition or covenant to persons or circumstances other than those as to whom or which it is held invalid or unenforceable, shall not be affected, and shall be valid and enforceable to the fullest extent permitted by Law.

**15.13 Computation of Time.** The time in which any act is to be done under this Ground Lease is computed by excluding the first day, and including the last day, unless the last day is a holiday or Saturday or Sunday, and then that day is also excluded. The term “holiday” shall mean all holidays as specified in Sections 6700 and 6701 of the California Government Code. If any act is to be done by a particular time during a day, that time shall be Pacific Time Zone time.

**15.14 Legal Advice.** Each party represents and warrants to the other the following: they have carefully read this Ground Lease, and in signing this Ground Lease, they do so with full knowledge of any right which they may have; they have received independent legal advice from their respective legal counsel as to the matters set forth in this Ground Lease, or have knowingly chosen not to consult legal counsel as to the matters set forth in this Ground Lease; and, they have freely signed this Ground Lease without any reliance upon any agreement, promise, statement or representation by or on behalf of the other party, or their respective agents, employees, or attorneys, except as specifically set forth in this Ground Lease, and without duress or coercion, whether economic or otherwise.

**15.15 Time of Essence.** Time is expressly made of the essence with respect to the performance by Landlord and Tenant of each and every obligation and condition of this Ground Lease.

**15.16 Nonliability of Officials, Employees, etc.** No member, official or employee of Landlord shall be personally liable to Tenant, or any successor in interest, in the event of any default or breach by Landlord or for any amount which may become due to Tenant or its successors, or on any obligations under the terms of this Ground Lease. Tenant hereby waives and releases any claim it may have against the members, officials or employees of Landlord with respect to any default or breach by Landlord or for any amount which may become due to Tenant or its successors, or on any obligations under the terms of this Ground Lease. No member, partner (other than general partners as otherwise permitted by law), or board member, officer or employee of Tenant (or of any of Tenant’s members or partners) shall be personally liable to Landlord, or any successor in interest, in the event of any default or breach by Tenant or for any amount which may become due to Landlord or its successors, or on any obligations under the terms of this Ground Lease. Landlord hereby waives and releases any claim it may have against Tenant’s members, partners (other than general partners as otherwise permitted by law), or board members, officers or employees (or of any of Tenant’s members or partners) with respect to any default or breach by Tenant or for any amount which may become due to Landlord or its successors, or on any obligations under the terms of this Ground Lease.

**15.17 Assignment by Landlord.** Landlord may assign or transfer any of its interests hereunder at any time without Tenant’s consent. Any such assignment or transfer shall be in compliance with all Laws, and the assignee or transferee shall affirmatively assume all Landlord obligations hereunder.

**15.18 Applicable Law.** The laws of the State of California, including all statutes of limitations but without regard to conflict of laws principles, shall govern the interpretation and enforcement of this Ground Lease.

**15.19 Covenants and Conditions.** Each obligation of the parties hereunder, including, without limitation, Tenant's obligation for the payment of Rent, shall be construed to be both a covenant and a condition of this Ground Lease.

**15.20 Integration.** This Ground Lease, together with all exhibits and attachments hereto, the Site REA, Hope Center REA, and Regulatory Requirements (collectively, "**Improvements Documents**"), excluding the City Financing Documents, constitute the entire agreement between the parties relating to the Premises and there are no conditions, representations or agreements regarding the matters covered by this Ground Lease which are not expressed herein or in the Improvements Documents. Without limiting the foregoing, except as expressly provided in this Ground Lease (including without limitation **Exhibit C**), this Ground Lease supersedes the DDA. Notwithstanding the foregoing, nothing herein will limit or restrict the rights of any party under the Improvements Documents and City Financing Documents.

**15.21 Amendments to this Ground Lease.** Landlord and Tenant agree to mutually consider reasonable requests for amendments to this Ground Lease that may be made by either of them, lending institutions or bond counsel or financial consultants to Landlord or Tenant, provided such requests are consistent with this Ground Lease and would not materially alter the basic business terms herein or the other Improvements Documents. No amendment shall be effective unless in writing and signed by the parties hereto.

**15.22 Proprietary and Governmental Roles: Actions by City.** Except where clearly and expressly provided otherwise in this Ground Lease, the capacity of the City in this Ground Lease shall be as owner and lessor of property only ("**Proprietary Capacity**"), and any obligations or restrictions imposed by this Ground Lease on the City shall be limited to that capacity and shall not relate to, constitute a waiver of, supersede or otherwise limit or affect its governmental capacities, including enacting laws, inspecting structures, reviewing and issuing permits, and all of the other legislative and administrative or enforcement functions pursuant to federal, state or local law ("**Governmental Capacity**"). When acting in its Proprietary Capacity, discretionary actions may be undertaken by the City Manager or other designees as designated by the City Manager to the extent otherwise provided herein. In addition, nothing in this Ground Lease shall supersede or waive any discretionary or regulatory approvals required to be obtained from the City under applicable Law.

**15.23 City Manager Authority and Limitations.** Any amendment to this Ground Lease which affects or relates to: (i) the Term of this Ground Lease; (ii) the permitted use of the Premises and Premises Improvements; (iii) Rent amounts and other monetary payments by Tenant; or (iii) any other material provision of this Ground Lease, shall require approval by the Landlord's City Council. Subject to the foregoing, the City Manager may also issue without City Council approval any consent or approval which Landlord is entitled to provide under this Ground Lease, including without limitation: (w) Material Alterations under Section 5.6 above; (x) assignments under Section 12.1; (y) sublettings under Section 12.2; and (z) rules for a CASp inspection under Section 15.29.

**15.24 Brokerage Commissions.** Landlord and Tenant each represents that it has not been represented by any broker in connection with this Ground Lease, and that no real

estate broker's commission, finder's fee or other compensation (individually and collectively, "**Brokerage Commission**") is due or payable. Landlord and Tenant each agrees to indemnify and hold the other harmless from any claims or liability, including reasonable attorneys' fees, in connection with a claim by any person for a Brokerage Commission based upon any statement, representation or agreement of the other party.

**15.25 City Non-Discrimination Ordinance.** Tenant hereby agrees to comply with the provisions of the Berkeley Municipal Code ("**B.M.C.**"), including without limitation Chapter 13.26, as amended from time to time. In the performance of its obligations under this Ground Lease, Tenant agrees as follows:

A. Tenant shall not discriminate against any employee or applicant for employment because of race, color, religion, ancestry, national origin, age (over 40), sex, pregnancy, marital status, disability, sexual orientation or AIDS.

B. Tenant shall permit Landlord access to records of employment, employment advertisements, application forms, EEO-1 forms, affirmative action plans and any other documents which, in the reasonable opinion of Landlord, are necessary to monitor compliance with this non-discrimination provision. In addition, Tenant shall fill out, in a timely fashion, forms supplied by Landlord to monitor this non-discrimination provision.

**15.26 Non-Discrimination Against Persons With Disabilities.**

A. If Tenant provides any aid, service or benefit to others on the Landlord's behalf, Tenant shall, in the provision of such aid, service or benefit, observe and comply with all applicable provisions of Title II of the Americans with Disabilities Act of 1990 and any amendments thereto. Tenant shall further observe and comply with all applicable federal, state, municipal and local laws, ordinances, codes and regulations prohibiting discrimination against individuals with disabilities or ensuring that individuals with disabilities are not excluded from participating in or receiving benefits, services or activities of the Landlord, if applicable.

B. If Tenant is or becomes a "public accommodation" as defined in Title III of the Americans with Disabilities Act of 1990, Tenant shall observe and comply with all applicable provisions of the Act and any amendments thereto, and all applicable federal, state, municipal and local laws, ordinances, codes and regulations prohibiting discrimination on the basis of disability in the full and equal enjoyment of goods, services, facilities, privileges, advantages, or accommodations offered by the Tenant. All of Tenant's activities must be in accordance with these laws, ordinances, codes, and regulations, and Tenant shall be solely responsible for complying therewith.

**15.27 Conflict of Interest Prohibited.**

A. In accordance with California Government Code Section 1090, Berkeley City Charter Section 36 and B.M.C. Chapter 3.64, neither Tenant nor any employee, officer, director, partner or member of Tenant, or immediate family member of any of the preceding, shall have served as an elected officer, an employee, or a committee or commission member of Landlord, who has directly or indirectly influenced the making of this Ground Lease.

B. In accordance with California Government Code Section 1090 and the Political Reform Act, (Government Code Section 87100 et seq.), no person who is a director, officer, partner, trustee, employee or consultant of Tenant, or immediate family member of any of

the preceding, shall make or participate in a decision made by Landlord or any of its boards, commissions or committees, if it is reasonable foreseeable that the decision will have a material effect on any source of income, investment or interest in real property of that person or Tenant, except to the extent permitted by 2 California Code of Regulations, Section 18700(c)(2).

C. Interpretation of this paragraph shall be governed by the definitions and provisions use in the Political Reform Act, Government Code section 87100 et seq., its implementing regulations, manuals and codes, Government Code section 1090, Berkeley City Charter section 36 and B.M.C. Chapter 3.64, as amended from time to time.

**15.28 Nuclear Free Berkeley.** Tenant agrees to comply with B.M.C. Chapter 12.90, the Nuclear Free Berkeley Act, as amended from time to time.

**15.29 Required Accessibility Disclosure.**

A. Landlord hereby advises Tenant that the Premises and Premises Improvements have not undergone an inspection by a certified access specialist, and except to the extent expressly set forth in this Ground Lease, Landlord shall have no liability or responsibility to make any repairs or modifications to the Premises or the Premises Improvements in order to comply with accessibility standards. The following disclosure is hereby made pursuant to applicable California law:

B. "A Certified Access Specialist (CASp) can inspect the subject premises and determine whether the subject premises comply with all of the applicable construction-related accessibility standards under state law. Although state law does not require a CASp inspection of the subject premises, the commercial property owner or lessor may not prohibit the lessee or tenant from obtaining a CASp inspection of the subject premises for the occupancy or potential occupancy of the lessee or tenant, if requested by the lessee or tenant. The parties shall mutually agree on the arrangements for the time and manner of the CASp inspection, the payment of the fee for the CASp inspection, and the cost of making any repairs necessary to correct violations of construction-related accessibility standards within the premises." [Cal. Civ. Code Section 1938(e)]. Any CASp inspection shall be conducted in compliance with reasonable rules in effect at the Premises with regard to such inspections and shall be subject to Landlord's prior written consent.

**15.30 Oppressive States.**

A. In accordance with Resolution No. 59,853-N.S., Tenant certifies that it has no contractual relations with, and agrees during the Term of this Ground Lease to forego contractual relations to provide personal services to, the following entities:

1. The governing regime in any Oppressive State.
2. Any business or corporation organized under the authority of the governing regime of any Oppressive State.
3. Any individual, firm, partnership, corporation, association, or any other commercial organization, and including parent-entities and wholly-owned subsidiaries (to the extent that their operations are related to the purpose of this Ground Lease) for the express purpose of assisting in business operations or trading with any public or private entity located in any Oppressive State.

B. For purposes of this Ground Lease, the Tibet Autonomous Region and the provinces of Abo, Kham, and U-Tsang shall be deemed oppressive states.

C. Tenant's failure to comply with this Section shall constitute a default of this Ground Lease and Landlord may terminate this Ground Lease pursuant to ARTICLE 13. In the event that Landlord terminates this Ground Lease due to a default under this provision, Landlord may deem Tenant a non-responsible bidder for five years from the date this Ground Lease is terminated.

**15.31 Berkeley Living Wage Ordinance (LWO).**

A. Tenant agrees to comply with Berkeley Municipal Code Chapter 13.27, the Berkeley Living Wage Ordinance. If Tenant employs six or more part-time or full-time employees, and generates \$350,000 or more in annual gross receipts, Tenant will be required to provide all eligible employees with City mandated minimum compensation during the Term of this Ground Lease, as defined in B.M.C. Chapter 13.27, and well as comply with the terms enumerated herein.

B. Tenant shall be required to maintain all reasonable records and documents that would establish whether Tenant is subject to Berkeley's Living Wage Ordinance ("LWO"). If Tenant is subject to the LWO, as defined therein, Tenant shall be further required to maintain monthly records of those employees located on the leased Premises. These records shall include the total number of hours worked, the number of hours spent providing service on the leased Premises, the hourly rate paid, and the amount paid by Tenant for health benefits, if any, for each of its employees providing services under the lease. The records described in this Section shall be made available upon the Landlord's request. The failure to produce these records upon demand shall be considered a default, subject to the provisions contained in ARTICLE 13 herein.

C. If Tenant is subject to the LWO, Tenant shall include the requirements of the ordinance, as defined in B.M.C. Chapter 13.27, in any and all subleases in which Tenant enters with regard to the subject Premises. Subtenants shall be required to comply with this ordinance with regard to any employees who spend 25% or more of their compensated time on the leased Premises.

D. If Tenant fails to comply with the requirements of the LWO and this Ground Lease, the Landlord shall have the rights and remedies described in this Section, in addition to any rights and remedies provided by law or equity.

E. Tenant's failure to comply with this Section shall constitute a default of the Ground Lease, upon which City may terminate this Ground Lease pursuant to ARTICLE 13.

F. In addition, at City's sole discretion, Tenant may be responsible for liquidated damages in the amount of \$50 per employee per day for each and every instance of an underpayment to an employee. It is mutually understood and agreed that Tenant's failure to pay any of its eligible employees at least the applicable living wage rate will result in damages being sustained by the City; that the nature and amount of the damages will be extremely difficult and impractical to fix; that the liquidated damages set forth herein is the nearest and most exact measure of damage for such breach that can be fixed at this time; and that the liquidated damage amount is not intended as a penalty of forfeiture for Tenant's breach.

**15.32 Berkeley Equal Benefits Ordinance (EBO).**

A. Tenant hereby agrees to comply with the provisions of the Berkeley Equal Benefits Ordinance, B.M.C. Chapter 13.29. If Tenant is currently or becomes subject to the Berkeley Equal Benefits Ordinance, Tenant will be required to provide all eligible employees with City mandated equal benefits during the Term of this Ground Lease, as defined in B.M.C. Chapter 13.29, as well as comply with the terms enumerated herein.

B. If Tenant is currently or becomes subject to the Berkeley Equal Benefits Ordinance, Tenant agrees to supply the City with any records the City deems necessary to determine compliance with this provision. Failure to do so shall be a considered a default, subject to the provisions of ARTICLE 13.

C. If Tenant fails to comply with the requirements of this Section, City shall have the rights and remedies described in this Section, in addition to any rights and remedies provided by law or equity. Tenant's failure to comply with this Section shall constitute default of the Ground Lease, upon which City may terminate this Ground Lease pursuant to ARTICLE 13.

D. In addition, at City's sole discretion, Tenant may be responsible for liquidated damages in the amount of \$50.00 per employee per day for each and every instance of violation of this Section. It is mutually understood and agreed that Tenant's failure to provide its employees with equal benefits will result in damages being sustained by City; that the nature and amount of these damages will be extremely difficult and impractical to fix; that the liquidated damages set forth herein is the nearest and most exact measure of damages for such breach that can be fixed at this time; and that the liquidated damage amount is not intended as a penalty or forfeiture for Tenant's breach.

**15.33 Audit.** In addition to any other Landlord audit right herein, the City Auditor's Office, or its designee, may conduct an audit of Tenant's financial and compliance records maintained in connection with the operations and services performed under this Ground Lease, and with the payments made under this Ground Lease. In the event of such audit, Tenant agrees to make all such financial and compliance records available to the Auditor's Office, or to its designee. City agrees to provide Tenant an opportunity to discuss and respond to any findings before a final audit report is filed.

**15.34 City Business License, Payment of Taxes, Tax I.D. Number.** Tenant has obtained a City business license as required by B.M.C. Chapter 9.04, and its license number is written below; or, Tenant is exempt from the provisions of B.M.C. Chapter 9.04 and has written below the specific B.M.C. section under which it is exempt. Tenant shall pay all state and federal income taxes and any other taxes due. Tenant certifies under penalty of perjury that the taxpayer identification number written below is correct.

**15.35 Survival.** The provisions of Sections 4.1 (Impositions), 5.6 (Alterations), 5.9 (Liens and Stop Notices), 6.2 (Governmental Requirements), 6.7 (General Standards of Maintenance), 7.2 (Hazardous Materials), 9.2 (Indemnity), 15.7 (Surrender) and any other obligation of Tenant that, by its terms or nature, is to be performed after or is to survive expiration or termination of this Ground Lease, shall survive such expiration or termination.

IN WITNESS WHEREOF, Landlord and Tenant have caused this Ground Lease to be executed on their behalf by their respective officers thereunto duly authorized as of the dates set forth below.

*[Signature Page Follows]*

**TENANT:**

BFHP Hope Center LP, a California limited partnership

By: \_\_\_\_\_

Print Name: \_\_\_\_\_

Its: \_\_\_\_\_

By: \_\_\_\_\_

Print Name: \_\_\_\_\_

Its: \_\_\_\_\_

Date: \_\_\_\_\_

**LANDLORD:**

CITY OF BERKELEY, a Charter city

By: \_\_\_\_\_

Dee Williams-Ridley  
City Manager

Date: \_\_\_\_\_

**Approved as to form:**

\_\_\_\_\_  
Farimah Brown, City Attorney

**Registered by:**

\_\_\_\_\_  
\_\_\_\_\_, City Auditor

**Attest:**

\_\_\_\_\_  
\_\_\_\_\_, City Clerk

**TENANT INFORMATION**

Tax Identification No. \_\_\_\_\_

Incorporated: Yes \_\_\_\_ No \_\_\_\_

Certified Woman Business Enterprise: Yes \_\_\_\_ No \_\_\_\_

Certified Minority Business Enterprise: Yes \_\_\_\_ No \_\_\_\_

Certified Disadvantaged Business Enterprise: Yes \_\_\_\_ No \_\_\_\_

City Business License No. \_\_\_\_\_, or  
Exempt pursuant to B.M.C. Section \_\_\_\_



**EXHIBIT A**

**PREMISES LEGAL DESCRIPTION**

The land referred to is situated in the City of Berkeley, County of Alameda, State of California, and is described as follows:

PARCEL ONE:

Parcel A, as shown on the Parcel Map 11051, filed \_\_\_\_\_, 2020 in Book \_\_\_ of Parcel Maps, Pages \_\_\_ and \_\_\_, Alameda County Records, EXCEPTING THEREFROM all buildings and improvements situated thereon, which buildings and improvements are and shall remain real property.

PARCEL TWO:

Easements for construction, maintenance, utilities, structural support and encroachment, set forth in that certain Declaration of and Agreement Regarding Covenants, Conditions and Restrictions Providing for Reciprocal Easements, Joint Use and Maintenance for Berkeley Way, dated \_\_\_\_\_, 2020, executed by the City of Berkeley and BRIDGE Berkeley Way LP and BFHP Hope Center LP, and recorded in Alameda County Records on \_\_\_\_\_, 2020, as Instrument No. \_\_\_\_\_; and Easements for access, use, ingress and egress, set forth in that certain Declaration of and Agreement Regarding Covenants, Conditions and Restrictions Providing for Reciprocal Easements, Joint Use and Maintenance for the BFHP Hope Center, dated \_\_\_\_\_, 2020, executed by the City of Berkeley and BFHP Hope Center LP, and recorded in Alameda County Records on \_\_\_\_\_, 20\_\_\_\_, as Instrument No. \_\_\_\_\_, 2020.

Being a portion of APN 057-2053-022-01

EXHIBIT B

DEVELOPMENT SITE PARCEL MAP

*[Draft to be attached—final to be included before signing]*

**EXHIBIT C**

**STATUS OF CERTAIN DDA PROVISIONS**

1. The following DDA provisions have been fully satisfied or waived:
  - a. Section 2.1 (Conditions Precedent to Lease of Property).
  - b. Section 2.2 (Developer Deposit).
  - c. Section 2.3 (Development Schedule).
  - d. Section 2.4 (Development Services Agreement).
  - e. Section 2.5 (Creation of and Assignments to Permitted Lessees).
  - f. Section 2.6 (Developer Approval of Property).
  - g. Section 2.7 (Developer Approval of Title Matters).
  - h. Section 2.8 (Agreement on Leases).
  - i. Section 2.9 (Agreement on Reciprocal Easement Agreement).
  - j. Section 2.10 (Agreement on Completion Guaranty Agreement).
  - k. Section 2.11 (City and Other Governmental Approvals).
  - l. Section 2.12 (Financing Proposals and Financing Plans for the Development).
  - m. Section 2.13 (Evidence of Availability of Funds).
  - n. Section 2.14 (Construction Contract(s)).
  - o. Section 2.15 (Construction Bonds).
  - p. Section 2.16 (Building Permits).
  - q. Section 2.17 (Construction Drawings).
  - r. Section 2.18 (Final Subdivision Map).
  - s. Section 2.19 (No Default).
  - t. Section 2.20 (Permits and Approvals Final; Absence of Litigation).
  - u. Section 2.21 (Insurance).
  - v. Section 2.22 (Representations and Warranties; No Material Adverse Change).

- w. Article III (Design Requirements), except for Sections 3.7 and 3.8.
- x. Article IV (Lease Disposition of Property) except for Sections 4.5 (see below), 4.6 (with respect to post-closing ad valorem taxes (if any) and other potential pre-closing and post-closing costs) and 4.7.

2. The following DDA provisions are terminated:

- a. Section 3.7 (No Change in Project Documents).
- b. Section 3.8 (Additional Permits and Approvals).
- c. Article VII (Assignment and Transfers).
- d. Article VIII (Termination, Default and Remedies). (Remedies for default in any continuing obligation under the DDA shall be as provided in the Ground Lease.)
- e. Section 9.3 (Enforced Delay).
- f. Section 9.19 (Right of Entry to Perform Studies).

3. The following DDA provisions, attached hereto, remain in full force and effect, except to the extent provided below:

- a. Section 4.5 (Condition of Property) remains in full force and effect.
- b. Section 4.6 (Costs of Escrow and Closing).
- c. Section 4.7 (Obligations After Lease).
- d. Article V (Construction of the Development) remains in full force and effect, and is incorporated into Section 5.1 of the Leases and the JDA.
- e. Article VI (Ongoing Developer Obligations) (except to the extent modified in the Ground Lease or as attached hereto).
- f. Section 9.1 (Notices, Demands and Communications), but only to the extent notices are required under the DDA, and not some other agreement with its own notice provisions.
- g. Section 9.2 (Non-Liability of City Officials, Employees and Agents), Section 9.4 (Inspection of Books and Records), Section 9.5 (Provision Not Merged with Leases) and Section 9.6 (Title of Parts and Sections) shall remain in full force and effect.
- h. Section 9.7 (Indemnification) shall remain in full force and effect against Developer except to the extent assumed by BRIDGE LP and BFHP LP, and otherwise in full force and effect against BRIDGE LP and BFHP LP.
- i. Section 9.8 (Applicable Law), Section 9.9 (No Brokers), Section 9.10 (Severability), Section 9.11 (Binding Upon Successors), Section 9.12 (Parties Not Co-Venturers), Section 9.13 (Time of the Essence), Section 9.14 (Action by the City), Section 9.15 (Discretion Retained by City), Section 9.16 (Representations and Warranties by Developer), and

Section 9.17 (Multiple Originals; Complete Understanding of the Parties), remain in full force and effect.

j. Except as provided in Leases Subsection 1.1A, Section 9.18 (Conflict Among City Documents) remains in full force and effect to the extent any applicable DDA provision remains in effect.

EXHIBIT D

SITE RECIPROCAL EASEMENT AGREEMENT (REA 1)

*[to be provided]*



EXHIBIT D1

HOPE CENTER RECIPROCAL EASEMENT AGREEMENT (REA 2)

*[to be provided]*





EXHIBIT E

RESOLUTION NO. AAAA-N.S.

*[to be attached]*



EXHIBIT F

INITIAL LEASEHOLD MORTGAGES AND MORTGAGEES

**[to be provided—identify “Senior Leasehold Mortgagee” if any and include notice addresses]**

EXHIBIT G

CITY FINANCING DOCUMENTS

*[to be provided]*





1-8-2020

Exhibit D

**GROUND LEASE  
2012 BERKELEY WAY  
(Berkeley Way Hope Center Temporary Housing)**

by and between

**CITY OF BERKELEY  
("Landlord")**

and

**BFHP Hope Center, LP**

**("Tenant")**

Dated \_\_\_\_\_, 2020



**TABLE OF CONTENTS**  
**(Ground Lease - Berkeley Way Hope Center Temporary Housing)**

	<b>Page</b>
ARTICLE 1. OVERVIEW AND GENERAL .....	1
<b>1.1 Overview</b> .....	1
<b>1.2 Ground Lease and Possession</b> .....	1
<b>1.3 Ownership of Premises Improvements</b> .....	1
<b>1.4 Changes to Premises and Parcel Map</b> .....	2
<b>1.5 Tenant’s Organizational Documents</b> .....	2
<b>1.6 Assignment of Ground Lease to BFHP LLC</b> .....	2
ARTICLE 2. GROUND LEASE TERM.....	2
<b>2.1 Term</b> .....	2
ARTICLE 3. RENT .....	3
<b>3.1 Rent</b> .....	3
<b>3.2 No Cost to Landlord: No Counterclaim, No Abatement</b> .....	3
<b>3.3 Additional Rent</b> .....	3
<b>3.4 Additional Consideration</b> .....	3
ARTICLE 4. TAXES AND ASSESSMENTS; SERVICES AND UTILITIES.....	3
<b>4.1 Impositions</b> .....	3
<b>4.2 Statement Regarding Possessory Interest Tax</b> .....	4
<b>4.3 Services and Utilities</b> .....	4
ARTICLE 5. DEVELOPMENT OF PREMISES IMPROVEMENTS; ALTERATIONS.....	5
<b>5.1 General</b> .....	5
<b>5.2 Commencement and Completion of Construction</b> .....	5
<b>5.3 Prior Development Matters</b> .....	5
<b>5.4 Non-Responsibility of Landlord</b> .....	6
<b>5.5 No Change in Project Documents</b> .....	6
<b>5.6 Alterations</b> .....	6
<b>5.7 Construction Standards</b> .....	7
<b>5.8 Protection of Landlord</b> .....	8
<b>5.9 Liens and Stop Notices</b> .....	8
<b>5.10 Notice</b> .....	9
<b>5.11 Miscellaneous</b> .....	9
ARTICLE 6. USE OF PREMISES, COMPLIANCE WITH LAWS .....	10
<b>6.1 General</b> .....	10
<b>6.2 Governmental Requirements</b> .....	10
<b>6.3 Tenant’s Right to Contest</b> .....	10

TABLE OF CONTENTS  
(Ground Lease - Berkeley Way Hope Center Temporary Housing)

	Page
6.4 Nuisance.....	10
6.5 General Use Prohibitions .....	11
6.6 Non-Discrimination.....	11
6.7 General Standards of Maintenance .....	11
6.8 Landlord’s Status as a Landowner.....	12
6.9 Regulatory Approvals Generally.....	12
ARTICLE 7. CONDITION OF PREMISES; HAZARDOUS MATERIALS; LANDLORD’S RIGHT OF ENTRY .....	12
7.1 Landlord’s Disclaimers and Tenant’s Acknowledgements.....	12
7.2 Hazardous Materials .....	12
7.3 Landlord’s Right to Enter Premises and Premises Improvements .....	13
ARTICLE 8. OWNERSHIP OF IMPROVEMENTS AND PERSONAL PROPERTY .....	14
8.1 Ownership of Premises Improvements During Term .....	14
8.2 Ownership of Premises Improvements at Termination or Expiration .....	14
8.3 Removal and Ownership of Personal Property at Termination or Expiration .....	14
ARTICLE 9. INSURANCE AND INDEMNITY .....	15
9.1 General Insurance Requirements .....	15
9.2 Indemnity.....	16
ARTICLE 10. DAMAGE OR DESTRUCTION.....	16
10.1 Restoration.....	16
10.2 Waiver.....	18
10.3 Determination of Extent of Destruction, Interference with Use .....	18
10.4 Procedures for Repair and Restoration.....	18
ARTICLE 11. CONDEMNATION.....	18
11.1 Definitions.....	18
11.2 Parties’ Rights and Obligations to be Governed by Ground Lease .....	19
11.3 Total Taking.....	19
11.4 Effect of Partial Taking .....	19
11.5 Restoration of Premises Improvements.....	19
11.6 Waiver of CCP Section 1265.130.....	19
11.7 Award.....	20
ARTICLE 12. ASSIGNMENT AND SUBLETTING .....	20
12.1 Assignment.....	20

**TABLE OF CONTENTS**  
**(Ground Lease - Berkeley Way Hope Center Temporary Housing)**

	<b>Page</b>
12.2 Subleases .....	21
ARTICLE 13. TENANT DEFAULTS AND LANDLORD’S REMEDIES .....	21
13.1 Defaults by Tenant .....	21
13.2 Remedies .....	22
13.3 Damages .....	23
13.4 Landlord’s Right to Cure Tenant’s Default .....	23
13.5 Guarantor Performance Under Completion Guaranty .....	23
ARTICLE 14. MORTGAGEE PROTECTION PROVISIONS .....	23
14.1 Right to Encumber .....	23
14.2 Leasehold Mortgagee as Third Party Beneficiary .....	24
14.3 Notice to Leasehold Mortgagee .....	24
14.4 Right of Leasehold Mortgagee to Cure .....	24
14.5 Limitation on Liability of Leasehold Mortgagee .....	25
14.6 Estoppel Certificates .....	25
14.7 Registration of Leasehold Mortgages .....	25
14.8 New Ground Lease .....	25
14.9 Rights of Investor .....	26
14.10 Transfers .....	26
14.11 Permitted Use Requirements .....	26
14.12 Further Ground Lease Amendments .....	27
ARTICLE 15. MISCELLANEOUS .....	27
15.1 Holding Over .....	27
15.2 Attorneys’ Fees .....	27
15.3 Quiet Possession .....	27
15.4 Force Majeure .....	27
15.5 Notices .....	28
15.6 Waiver .....	28
15.7 Surrender .....	28
15.8 Binding .....	28
15.9 Disclaimer of Partnership .....	28
15.10 Quitclaim .....	28
15.11 Interpretation .....	29
15.12 Severability .....	29

TABLE OF CONTENTS  
(Ground Lease - Berkeley Way Hope Center Temporary Housing)

	Page
15.13 Computation of Time .....	29
15.14 Legal Advice.....	29
15.15 Time of Essence.....	29
15.16 Nonliability of Officials, Employees, etc.....	29
15.17 Assignment by Landlord .....	30
15.18 Applicable Law.....	30
15.19 Covenants and Conditions.....	30
15.20 Integration .....	30
15.21 Amendments to this Ground Lease.....	30
15.22 Proprietary and Governmental Roles: Actions by City .....	30
15.23 City Manager Authority and Limitations.....	31
15.24 Brokerage Commissions .....	31
15.25 City Non-Discrimination Ordinance.....	31
15.26 Non-Discrimination Against Persons With Disabilities.....	31
15.27 Conflict of Interest Prohibited.....	32
15.28 Nuclear Free Berkeley .....	32
15.29 Required Accessibility Disclosure.....	32
15.30 Oppressive States.....	33
15.31 Berkeley Living Wage Ordinance (LWO).....	33
15.32 Berkeley Equal Benefits Ordinance (EBO).....	34
15.33 Audit .....	34
15.34 City Business License, Payment of Taxes, Tax I.D. Number .....	35
15.35 Survival.....	35

TABLE OF CONTENTS  
(Ground Lease - Berkeley Way Hope Center Temporary Housing)

Page

LIST OF EXHIBITS

<u>Exhibit A</u>	Premises Legal Description
<u>Exhibit B</u>	Development Site Parcel Map
<u>Exhibit C</u>	Status of Certain DDA Provisions
<u>Exhibit D</u>	Site Reciprocal Easement Agreement (REA 1)
<u>Exhibit D1</u>	Hope Center Reciprocal Easement Agreement (REA 2)
<u>Exhibit E</u>	City Resolution No. AAAA-N.S. [ <b><i>Approving the final Leases</i></b> ]
<u>Exhibit F</u>	Initial Leasehold Mortgages and Mortgagees
<u>Exhibit G</u>	City Financing Documents

**BASIC LEASE INFORMATION**  
**(Ground Lease - Berkeley Way Hope Center Temporary Housing)**

1. **“Landlord”**

CITY OF BERKELEY, a Charter city

Notice Address:

City of Berkeley  
2180 Milvia Street  
Berkeley, California 94704  
Attention: City Manager  
Telephone: (510) 981-7000  
Facsimile: (510) 981-7099

With a copy to:

City of Berkeley  
2180 Milvia Street, 4<sup>th</sup> floor  
Berkeley, California 94704  
Attention: City Attorney  
Telephone: (510) 981-6991  
Facsimile: (510) 981-6960

And

City of Berkeley HHCS  
2180 Milvia Street, 2<sup>nd</sup> floor  
Berkeley, California 94704  
Attention: Housing & Community Services Manager  
Telephone: (510) 981-5400  
Facsimile: (510) 981-5450

2. **“Tenant”**

BFHP Hope Center LP

Notice Address:

BFHP Hope Center LP  
c/o BRIDGE Housing Corporation  
600 California Street, Suite 900  
San Francisco, CA 94108  
Attn: General Counsel

BFHP Hope Center LP  
c/o Berkeley Food and Housing Project  
1901 Fairview Street  
Berkeley, CA 94703  
Attn: Executive Director

3. **“Ground Lease Date”**

The date set forth in the first paragraph below.

4. **“DDA”**

That certain Disposition and Development Agreement (Berkeley Way Development), originally dated June 8, 2016 between Landlord and Bridge Housing Corporation, a California nonprofit public benefit corporation, as amended by First Amendment to Disposition and Development Agreement dated August 27, 2018, as partially assigned to Tenant pursuant to that certain

**BASIC LEASE INFORMATION**  
**(Ground Lease - Berkeley Way Hope Center Temporary Housing)**

Partial Assignment and Assumption Agreement dated December 17, 2018 and recorded in Official Records of Alameda County on December 21, 2018 as Instrument No. 18-241567, as amended by the Second Amendment to Disposition and Development Agreement, dated February 1, 2019 and recorded in Official Records of Alameda County on February 14, 2019 as Instrument No. 2019029062, and as further partially assigned to BRIDGE Berkeley Way LP and amended pursuant to that certain Assignment and Third Amendment to DDA dated \_\_\_\_\_, 2020 and recorded in Official Records of Alameda County on \_\_\_\_\_, 2020 as Instrument No. \_\_\_\_\_. See **Exhibit C** hereto.

5. **“Premises”** The Premises is described in **Exhibit A**, being primarily Parcel B of the Parcel Map (defined below).
6. **“Development Site” or “Site”** That certain approximately 1-acre (approximately 41,000 square feet) parcel of real property generally located at 2012 Berkeley Way, between Milvia Street and Shattuck Avenue (previously APN 57-2053-22-1) in the City of Berkeley, which is the subject of the DDA.
- The Development Site has been divided into three parcels, pursuant to that certain Parcel Map 11051, filed \_\_\_\_\_, 2020 in Book \_\_\_ of Parcel Maps, Pages \_\_\_ and \_\_\_, Alameda County Records (the **“Parcel Map”**), a copy of which is attached hereto as **Exhibit B**. Generally, the three parcels are the **“BRIDGE Affordable Parcel”** (Parcel Map Parcel C), the **“Permanent Supportive Housing Parcel”** (Parcel Map Parcel A), and the **“Temporary Housing Parcel”** (Parcel Map Parcel B).
7. **“Development” or “Project”** The entire development project to be planned, entitled, developed, financed, designed, constructed, operated and maintained on the Development Site. The overall Development is a six story building with approximately 140,000 square feet of gross interior floor space, with associated landscaping and hardscape, and includes:
- The Temporary Housing Parcel and the Temporary Housing Improvements. The **“Temporary Housing Improvements”** consists of approximately 44 beds of temporary housing, a services center and administrative office space. The Temporary Housing Improvements are located within the Temporary Housing Parcel.
  - The Permanent Supportive Housing Parcel and the Permanent Supportive Improvements. The

**BASIC LEASE INFORMATION**  
**(Ground Lease - Berkeley Way Hope Center Temporary Housing)**

**“Permanent Supportive Housing Improvements”** consist of approximately 53 permanent supportive housing units and supportive service spaces. The Permanent Supportive Housing Improvements are located within the Permanent Supportive Housing Parcel.

- The BRIDGE Affordable Parcel and the BRIDGE Improvements. The **“BRIDGE Improvements”** consist of 89 affordable housing units (including one manager’s unit) and related improvements. The BRIDGE Improvements are located within the BRIDGE Affordable Parcel.

8. **“Permitted Use”** Homeless and community services, subject to the Regulatory Requirements and all other provisions of this Ground Lease.

9. **“Premises Improvements”** The Temporary Housing Improvements, collectively, together with all additions, alterations, modifications, replacements and improvements from time to time pursuant to this Ground Lease.

10. **“REA 1” or “Site REA” or “Berkeley Way REA”** That certain Declaration of and Agreement Regarding Covenants, Conditions and Restrictions Providing for Reciprocal Easements, Joint Use and Maintenance for Berkeley Way, dated \_\_\_\_\_, 2020, executed by the City of Berkeley and BRIDGE Berkeley Way LP and BFHP Hope Center LP, and recorded in Alameda County Records on \_\_\_\_\_, 2020 as Instrument No. \_\_\_\_\_, substantially in form attached hereto as **Exhibit D**.

11. **“REA 2” or “Hope Center REA”** That certain Declaration of and Agreement Regarding Covenants, Conditions and Restrictions Providing for Reciprocal Easements, Joint Use and Maintenance for the BFHP Hope Center, dated \_\_\_\_\_, 2020, executed by the City of Berkeley and BFHP Hope Center LP, and recorded in Alameda County Records on \_\_\_\_\_, 2020 as Instrument No. \_\_\_\_\_, substantially in form attached hereto as **Exhibit D1**.

12. **“Regulatory Requirements”** Includes, collectively, (i) that certain Regulatory Agreement and Declaration of Restrictive Covenants (Berkeley Way Hope Center Temporary Housing), dated \_\_\_\_\_, 20\_\_, between Landlord and Tenant and recorded in Official Records of Alameda County on \_\_\_\_\_, 2020 as Instrument No. \_\_\_\_\_, and any amendments approved by



**BASIC LEASE INFORMATION**  
**(Ground Lease - Berkeley Way Hope Center Temporary Housing)**

Landlord and Tenant, and (ii) any regulatory or affordability agreement or other covenant, condition or restriction in favor of Landlord and recorded against the Premises.

13. **“Leasehold Mortgage,”  
“Permitted Leasehold  
Mortgagee” and “Senior  
Leasehold Mortgagee”** As identified in **Exhibit F** attached hereto. See also ARTICLE 14 below.
14. **“Investor(s)”** *[to be provided, including notice addresses]*
15. **“Term”** The period of time commencing on the Ground Lease Date and ending on the last day of the month in which the 75<sup>th</sup> anniversary of the Ground Lease Date occurs, subject to earlier termination as provided elsewhere in this Ground Lease.
16. **“Developer”** BRIDGE Housing Corporation, a California nonprofit public benefit corporation.
17. **“BFHP”** Berkeley Food and Housing Project, a California religious corporation
18. **“JDA”** Joint Development Agreement, dated \_\_\_\_\_, 20\_\_ between Tenant and BRIDGE Berkeley Way LP, a California limited partnership.
19. **“Developer Agreement”** Prior to the Ground Lease Date, the Development Services Agreement, dated \_\_\_\_\_, 20\_\_ among Developer, Tenant and BRIDGE Berkeley Way LP, a California limited partnership; and after the Ground Lease Date the Development Services Agreement, dated \_\_\_\_\_, 20\_\_ between Developer and Tenant.
20. **“Construction Schedule”** The final approved Construction Schedule for the Premises and Project, as amended from time to time pursuant to ARTICLE 5 below.
21. **“Lease Transfer  
Agreement” or “Transfer  
Agreement”** Lease Transfer Agreement, dated \_\_\_\_\_, 20\_\_ between Tenant and BFHP Hope Center LLC, a California limited liability company (“**BFHP LLC**”), together with such changes as City may approve.
22. **“Premises Substantial  
Completion”** Obtaining a temporary certificate of occupancy for the Premises and Project.
23. **“Premises Substantial  
Completion Date”** The earlier of 40 months following the commencement of Project construction and July 31, 2024.

**BASIC LEASE INFORMATION**  
**(Ground Lease - Berkeley Way Hope Center Temporary Housing)**

24. **“Guarantor” and “Completion Guaranty”** Developer, as **[Guarantor]** under that certain **[Construction Completion Guaranty]** in favor of the Landlord, dated on or about the Ground Lease Date, together with such changes as Landlord may approve.
25. **“Base Rent”** \$500 for the entire Term.
26. **“Additional Rent”** Is defined in Section 3.3 below.
27. **“Interest Rate”** The maximum rate permitted under Section 1(2) of Article XV of the California Constitution.
28. **“County”** The County of Alameda, California.
29. **“State”** The State of California.
30. **“City”** City of Berkeley, California.
31. **“Code”** The Internal Revenue Code of 1986, as amended from time to time.
32. **“CPI”** The Consumer Price Index (1982-84=100) for all Urban Consumers published by the United States Department of Labor, Bureau of Labor Statistics for the San Francisco-Oakland-Hayward area, or any successor thereof.
33. **“City Financing Documents”** See Section 1.2 below and **Exhibit G** attached hereto.

The Basic Ground Lease Information set forth above and the Exhibits attached hereto are incorporated into and made a part of the following Ground Lease.

**LANDLORD'S INITIALS**\_\_\_\_\_

**TENANT'S INITIALS**\_\_\_\_\_

**GROUND LEASE  
2012 BERKELEY WAY  
(Berkeley Way Hope Center Temporary Housing)**

THIS GROUND LEASE (“**Ground Lease**”) is made and entered into this \_\_\_ day of \_\_\_\_\_, 2020 (the “**Ground Lease Date**”), by and between the Landlord and Tenant identified in the Basic Ground Lease Information, who agree as follows:

**ARTICLE 1.  
OVERVIEW AND GENERAL**

**1.1 Overview.**

A. General Purpose of Development; Authority. Landlord owns the Site. Landlord entered into the DDA to cause the construction and operation of the Development on the Site for temporary, affordable and permanent supportive housing, and homeless services to help address the City’s homeless and affordability crisis, existing as of the Ground Lease Date. This Ground Lease facilitates one component of the Development. Landlord is entering into two additional ground leases, with an affiliate of Tenant, to implement the other two components of the Development, which components are further described in Basic Lease Information Section 7. In the event of a conflict between the DDA and this Ground Lease, this Ground Lease supersedes the DDA and will control. (See also Exhibit C hereto.) Landlord’s execution of this Ground Lease and the additional ground leases was authorized by City Council Resolution No. AAAA-N.S. attached hereto as Exhibit E.

B. Specific Purpose of Ground Lease. Landlord is entering into this Ground Lease to permit Tenant to construct, operate and maintain the Premises Improvements for the Permitted Use.

C. Regulatory Requirements. The parties intend that the Regulatory Requirements will survive for the full term therein, notwithstanding any prior termination or expiration of this Ground Lease or (except as provided in ARTICLE 14) foreclosure of any Permitted Leasehold Mortgage.

D. City Financing Documents. Nothing in this Ground Lease shall limit any City right under any regulatory or financing agreements between the City and Tenant (or by Tenant for the benefit of City), or under any Regulatory Requirement.

**1.2 Ground Lease and Possession.** For and in consideration of the payment of Rent and the performance of all the covenants and conditions of this Ground Lease, as of the Ground Lease Date Landlord hereby leases and demises to Tenant, and Tenant hereby leases and hires from Landlord, the Premises, for the Term and upon the covenants and conditions set forth herein. On the Ground Lease Date, Tenant shall obtain exclusive possession of the Premises.

**1.3 Ownership of Premises Improvements.** At all times during the Term of this Ground Lease, (i) the Premises Improvements shall be owned by Tenant, (ii) Tenant alone shall be entitled to all of the tax attributes of ownership, including, without limitation, the right to claim depreciation or cost recovery deductions and the right to claim the low-income housing tax credit described in Section 42 of the Internal Revenue Code of 1986, as amended, and (iii)

Tenant shall have the right to amortize capital costs and to claim any other federal or state tax benefits attributable to the Premises Improvements.

**1.4 Changes to Premises and Parcel Map.** Tenant shall not alter the definition of the Premises, modify the Parcel Map, or further subdivide, by map, subdivision map, or otherwise, the Premises or any portion thereof, without the prior written consent of Landlord, which Landlord may grant or withhold in its sole discretion.

**1.5 Tenant's Organizational Documents.** Tenant has previously provided Landlord with correct and complete copies of organizational documents for itself and (as applicable) its general partner(s) and managing member(s), including without limitation articles of organization, certificates of limited partnership, limited partnership agreements, limited liability company agreements, and the like. Tenant will provide Landlord copies of all amendments and modifications promptly following adoption thereof, and copies of such other organizational documents as Landlord may reasonably request from time to time. Any such amendment or modification which materially alters Landlord's rights herein, or under the Site REA, Hope Center REA, or Regulatory Requirements is subject to Landlord's reasonable consent.

**1.6 Assignment of Ground Lease to BFHP LLC.**

A. Following Premises Substantial Completion, Tenant may convey its interest in this Ground Lease and the Premises Improvement to BFHP LLC pursuant to the Lease Transfer Agreement, in which event Tenant and BFHP LLC shall enter into an assignment of this Ground Lease ("**Lease Assignment**") and grant deed ("**Grant Deed**"), each substantially in form attached to the Transfer Agreement, or in such other form as Landlord may approve in its reasonable discretion (the "**Assignment**"). Concurrently with the effective date of the Assignment, Tenant shall record in the Official Records of Alameda County (i) the Lease Assignment (or memorandum thereof) and (ii) Grant Deed, and upon recording thereof (except as provided in the Transfer Agreement) Tenant shall be released from any and all obligations under this Ground Lease arising after the effective date of the Assignment. Tenant will pay all costs of recording, including any County documentary transfer tax or City conveyance tax, the cost of any title insurance it may require and any escrow to implement the transaction.

B. Nothing in this Section shall prevent Tenant from entering into a temporary sublease with BFHP LLC to operate the Temporary Housing Improvements pursuant to this Ground Lease and the Regulatory Agreement prior to the transfer of this Ground Lease and the Temporary Housing Improvements to the BFHP LLC pursuant to the Lease Transfer Agreement as described in Section 1.6A.

**ARTICLE 2.  
GROUND LEASE TERM**

**2.1 Term.** The Term of this Ground Lease shall be as set forth in the Basic Ground Lease Information.

**ARTICLE 3.  
RENT**

**3.1 Rent.** Tenant shall pay the Base Rent specified in the Basic Ground Lease Information on or before the Ground Lease Date. Base Rent and any Additional Rent (collectively, “**Rent**”) shall be paid without notice or demand, and, except as specifically provided for in this Ground Lease, without offset, deduction or credit. All Rent (other than Additional Rent payable to entities other than Landlord) shall be payable in lawful money of the United States to Landlord at the address stated herein or to such other persons or at such other places as Landlord may designate from time-to-time in writing.

**3.2 No Cost to Landlord: No Counterclaim, No Abatement.** Except as otherwise expressly provided in this Ground Lease, all Rent payable under this Ground Lease shall be absolutely net to Landlord. Except as otherwise expressly provided in this Ground Lease, Tenant shall pay Rent without assertion of any counterclaim, setoff, deduction or defense and without abatement, suspension, deferment, diminution or reduction.

**3.3 Additional Rent.** “**Additional Rent**” means all sums, Impositions (as defined in Section 4.1 below), costs, expenses, and other payments for which Tenant is responsible pursuant to this Ground Lease. Tenant’s obligation to pay Additional Rent shall begin to accrue on the Ground Lease Date and shall continue to accrue throughout the Term. Additional Rent shall be payable by Tenant to the appropriate party on or before the date required by this Ground Lease. In addition to and not by way of limitation of Landlord’s rights under specific provisions of this Ground Lease, Landlord shall at all times have the right (at its sole election and without any obligation to do so) to advance on behalf of Tenant any amount, subject to Tenant’s right to contest such charges and provided that (except in case of emergency calling for immediate payment) Landlord shall first have given Tenant no less than 10 business days’ advance written notice of Landlord’s intent to advance such amounts on behalf of Tenant. No advance by Landlord shall operate as a waiver of any Landlord right under this Ground Lease and Tenant shall remain fully responsible for the performance of its obligations under this Ground Lease. All amounts advanced by Landlord as provided in this Section shall constitute “**Additional Rent**” under this Ground Lease, shall be due and payable by Tenant to Landlord within five business days of Tenant’s receipt of an invoice from Landlord therefor, and shall bear interest at the Interest Rate until paid in full.

**3.4 Additional Consideration.** In addition to the Rent and Additional Rent provided for herein, consideration for this Ground Lease shall also be and is Tenant’s full and complete compliance with all terms, conditions, warranties and covenants contained in the Regulatory Requirements and this Ground Lease relating to the planning, entitling, developing, financing, designing, constructing, operating and maintaining the Premises and Premises Improvements.

**ARTICLE 4.  
TAXES AND ASSESSMENTS; SERVICES AND UTILITIES**

**4.1 Impositions.** Tenant shall pay or cause to be paid, when due to the proper authority, any and all valid taxes, assessments, impositions, fees and similar charges on the Premises or Premises Improvements which become effective after the Ground Lease Date, including all taxes levied or assessed on the possession, use or occupancy of the Premises (as distinguished from the ownership of the Premises), and all taxes levied or assessed on the ownership, possession, use or occupancy of the Premises Improvements (collectively,

**“Impositions”**). Tenant shall not permit any Impositions to become a defaulted lien on the Premises or Premises Improvements; provided, however, that in the event any Imposition is payable in installments, Tenant may make, or cause to be made, payment in installments; and, provided further, that Tenant may contest the legal validity or the amount of any tax, assessment, imposition, fee or similar charge, through such proceedings as Tenant considers necessary or appropriate, and Tenant may defer the payment thereof so long as the validity or amount thereof shall be contested by Tenant in good faith and without expense to the Landlord. In the event of any such contest, Tenant shall protect, defend and indemnify the Landlord against all loss, cost, expense or damage resulting there from, and should Tenant be unsuccessful in any such contest, Tenant shall forthwith pay, discharge, or cause to be paid or discharged, such tax, assessment, imposition, fee or other similar charge. Landlord hereby consents to and shall reasonably cooperate and assist with Tenant applying for and obtaining any applicable exemptions from taxes or assessments levied on the Premises, the Premises Improvements and on Tenant’s interest therein. Tenant shall have no obligation to pay Impositions pursuant to this Section that are due and payable prior to the Ground Lease Date, including without limitation any taxes, assessments, impositions, fees or other charges levied against the Premises which are incurred prior to the Ground Lease Date. Any Imposition relating to a period, only a part of which is included within the Term, shall be prorated as between Landlord and Tenant so that Landlord shall pay (if Landlord is subject to such Impositions) the portion of Impositions attributable to any period prior to the Ground Lease Date or subsequent to the expiration of this Ground Lease, and Tenant shall pay the portion thereof attributable to any period during the Term. Nothing contained in this Ground Lease shall be deemed to require the payment by Tenant of any income, franchise, estate, inheritance, succession or capital levy tax of Landlord.

**4.2 Statement Regarding Possessory Interest Tax.** This Ground Lease creates a possessory property interest in Tenant. Tenant acknowledges and agrees that Tenant’s leasehold and/or other real property interests may be subject to property taxation, and Tenant or the party in whom the possessory property interest is vested may be subject to the payment of property taxes levied on the interest. Such taxes (unless Tenant establishes an exemption) shall be paid by Tenant as part of Impositions as provided in this Ground Lease.

**4.3 Services and Utilities.** Tenant shall pay, or cause to be paid, all charges that are incurred by Tenant or that might be a charge or lien against the Premises or Premises Improvements for gas, water, electricity, telephone or other communication service, janitorial service, debris removal, or any other utility or service used, rendered or supplied upon or in connection with the Premises Improvements, throughout the Term (**“Utilities”**). Such charges shall include the cost of installing and metering such utility services. Tenant shall maintain, repair and (if necessary) replace all Utility facilities and installations in, on, about or otherwise serving the Premises or Premises Improvements. Landlord grants to Tenant the right to grant to public entities or public service corporations, for the purpose of serving only the Premises during the Term of this Ground Lease, rights-of-way or easements on or over the Site, for poles or conduits or both, and for other utilities and municipal or special district services; provided, however, that Tenant shall not grant any such rights of way or easements that would adversely affect or create safety problems in connection with the use or operation, or access to and from, the BRIDGE Affordable Parcel or Permanent Supportive Housing Parcel, or any adjoining property. Landlord shall join in the execution of or consent to any such rights of way or easements. Tenant shall promptly provide to Landlord copies of all rights-of-way and easements so granted. Tenant, or third parties other than Landlord, shall bear all costs and expenses incurred in connection with the granting of any such rights-of-way and easements.

**ARTICLE 5.  
DEVELOPMENT OF PREMISES IMPROVEMENTS; ALTERATIONS**

**5.1 General.** Tenant shall plan, entitle, develop, finance, design and construct the Premises Improvements on the Premises pursuant to and in compliance with all the terms and conditions set forth in DDA Article 5, this ARTICLE 5, the JDA, the Developer Agreement and the Construction Schedule. In the event of any conflict between this Ground Lease and the DDA, this Ground Lease shall control. Without limiting the foregoing:

A. Tenant shall notify Landlord regarding (i) any material breaches or defaults, and (ii) any schedule issues that may impair Tenant's ability to substantially complete the Premises Improvements prior to the date contained in the latest Construction Schedule; and

B. Tenant shall require its General Contractor performing the initial construction of the Premises Improvements to prepare all schedule updates required by the Construction Contract and promptly provide copies to Landlord.

**5.2 Commencement and Completion of Construction.** Tenant shall commence construction of the Premises Improvements no later than 30 days following the Ground Lease Date, and shall use diligent efforts to complete construction (subject to Force Majeure delays as defined in delays as defined in Section 15.4 below) no later than the Premises Substantial Completion Date. As between Tenant and Landlord, Tenant shall bear all costs and expenses to complete, or cause the completion of, the Premises Improvements within the time period set forth in the Construction Schedule, including without limitation any cost overruns and changes (regardless of Landlord's approval of any changes) for the Premises Improvements.

**5.3 Prior Development Matters.**

A. Site and Title Approvals. By its execution and delivery of this Ground Lease, Tenant confirms that it has approved all matters relating to the Site and title matters, as provided in DDA Sections 2.6, 2.7 and 4.5.

B. City and Governmental Approvals; CEQA Litigation. By its execution and delivery of this Ground Lease, Tenant and Landlord confirm that Tenant has obtained all City Approvals (as defined in the DDA). Tenant confirms that it has obtained all other governmental approvals necessary for the development and operation of the Premises and the Premises Improvements, as provided in DDA Section 2.11. If any third party commences litigation objecting to or otherwise challenging any action or omission under California Environmental Quality Act ("CEQA") with respect to the Premises or any of Landlord's land use approvals relating to this Ground Lease, the Premises Improvements or the use or occupancy thereof, Tenant shall indemnify, hold harmless and defend Landlord (with defense counsel selected by Tenant and reasonably acceptable to Landlord) for any and all liabilities, losses, costs or expenses, including attorney fees or fees for the use of experts or consultants, incurred as a result of any such claim, litigation or challenge. No settlement shall be entered into without Landlord's full consent and approval.

C. Construction Drawings and Specifications. By its execution and delivery of this Ground Lease, Tenant and Landlord confirm that Tenant has obtained all required City approvals for the Final Construction Drawings in accordance with DDA Sections 2.17 and 3.4.

**5.4 Non-Responsibility of Landlord.** Tenant shall be solely responsible for all aspects of its conduct in connection with the Premises Improvements, including, but not limited to, the quality and suitability of the final drawings and specifications, the supervision of construction work, and the qualifications, financial condition, and performance of all architects, engineers, contractors, subcontractors, suppliers, consultants, and property managers. Any review, inspection or approval undertaken by Landlord is solely for the purpose of determining whether the Tenant is properly discharging its obligations to Landlord, and should not be relied upon by Tenant, Developer or any other third parties as a warranty or representation by Landlord as to the quality of the design or construction of the Premises Improvements.

**5.5 No Change in Project Documents.** From and after the Ground Lease Date until Premises Substantial Completion, except as set forth in DDA Section 5.1, Tenant shall not make any Material Change to the Final Construction Drawings or permit others to make any Material Change without the Landlord's prior written approval. As used in this Section 5.5 "**Material Change**" means (i) any change in the work the cost of which exceeds Two Hundred Fifty Thousand Dollars (\$250,000); or (ii) any set of changes in the work the cost of which cumulatively exceeds Five Hundred Thousand Dollars (\$500,000); or (iii) any material change in building materials or equipment, or the structural or architectural design or appearance of the Development as provided for in the plans and specifications approved by the City Building Department. From and after the Ground Lease Date until Premises Substantial Completion, Tenant shall not make any changes to the Construction Schedule or permit others to do so, without the Landlord's prior written approval, which shall not unreasonably be withheld.

**5.6 Alterations.**

A. Alterations shall also be governed by this Ground Lease, including without limitation applicable provisions of this ARTICLE 5. "**Alterations**" include modifications or additions to the Premises Improvements following Premises Substantial Completion, including without limitation Material Alterations. "**Material Alterations**" means (a) the construction of any new additional building or structure, (b) an increase in the bulk or height of the Premises Improvements, (c) any material alteration of exterior architectural designs, colors or materials (unless the applicable exterior component is not reasonably available or does not meet current code requirements, and Tenant uses materials of equal quality, durability, design standards, and appearance to the materials originally installed), or (d) reconstruction following fire or other casualty in excess of \$300,000 (subject to adjustment pursuant to the CPI from and after the Ground Lease Date). Any Alterations shall be in compliance with applicable Laws and permits, shall at all times be of first-class construction and architectural design. Material Alterations shall be in accordance with all plans and specifications therefor submitted to and approved by Landlord as set forth below. No material changes to such approved plans and specifications shall be made without Landlord's prior written approval. All Alterations shall be diligently prosecuted, completed, and accomplished without cost or expense to Landlord, by licensed contractors, and in a first-class and workmanlike manner.

B. Except with Landlord's prior written consent, which may be granted or denied in Landlord's reasonable discretion, Tenant shall not make or cause to be made any Material Alterations as set forth below. If Tenant at any time following Premises Substantial Completion desires to undertake any Material Alterations, Tenant shall, prior to the commencement of such work, prepare or cause to be prepared, at its sole expense, and shall submit to Landlord for its review, cost estimates, plans and specifications for such work, showing, without limitation, scaled elevations, scaled floor plans, design concepts, dimensions, material selection, colors, signing (if any) and such additional information as is reasonably



requested by Landlord to make an informed decision on such submission. The plans and specifications shall comply with this Ground Lease and shall be in compliance with applicable Laws. Landlord shall approve or disapprove such submitted plans within 30 days of receipt of complete plans and specifications meeting the requirements of this subsection. In the event Landlord disapproves a submittal pursuant to this Section, Landlord shall submit a list of reasons for the disapproval to the Tenant together with its notice of such disapproval. Failure of the Landlord to approve or disapprove such plans and specifications within such 30-day period shall be deemed to be Landlord's disapproval. Nothing herein or in any other agreement relating to the Development shall require Landlord to approve Material Alterations which would cause the Building (including any solar canopy or other energy facilities) to be greater than 206 feet high or include more than 167,000 interior square feet.

**5.7 Construction Standards.** The following standards (as applicable) shall apply to the design and construction of all Premises Improvements and Alterations under this Ground Lease.

A. Approval of Contractor and Materials. Landlord's approval of Tenant's contractor or other person engaged to perform the work is required for all Premises Improvements and Alterations with an aggregate cost exceeding \$250,000 (subject to adjustment pursuant to the CPI from and after the Ground Lease Date) for any single instance, and for such other matters as Landlord may request from time to time.

B. Contracts, Plans and Specifications. Subject to the rights of Leasehold Mortgagees and Tenant's Investor, all contracts with any architect, other design professional or any general contractor for the original construction of the Premises Improvements or the construction of Material Alterations shall provide for the assignment thereof to Landlord as security to Landlord for Tenant's performance hereunder.

C. General Construction Standards. Except as otherwise expressly provided in this Ground Lease, all Tenant construction contractors and subcontractors shall be licensed. Tenant shall require any general contractor to institute an appropriate safety program to assure the safety and convenience of all persons. In addition, Tenant shall pay (or cause to be paid) all costs and expenses associated with Tenant's work and shall indemnify, defend and hold Landlord harmless from all liabilities, damages, losses or claims attributable to the Tenant's construction of the Premises Improvements, or of any subsequent Alterations on or about the Premises, as the case may be, and the performance of Tenant's work. Dust, noise and other effects of Tenant's work shall be controlled by Tenant as required by the applicable conditions of approval of the Premises Improvements and applicable Laws so as to minimize deleterious effects associated with construction projects in a populated or developed area. Tenant shall identify an individual representative to address any neighborhood complaints related to its construction work and Tenant shall respond promptly to any neighborhood complaints. Tenant shall be required, at Tenant's expense, to obtain any and all air quality and other permits required of Tenant in connection with Tenant's construction.

D. Public Safety. Without limiting the generality of the Subsection 5.7C above, as between Landlord and Tenant, Tenant shall have the sole responsibility for implementing all necessary safeguards for the protection of workers and the public.

E. Permits. To the extent that any Premises Improvements or Alterations require a building permit or other permits from the City of Berkeley and/or any other

governmental agency, Tenant shall not perform any Alterations until Tenant has obtained all requisite permits.

F. Prevailing Wage Laws. Tenant shall comply with all prevailing wage requirements of California Labor Code Sections 1720 et seq. Tenant agrees that to the extent it is required to comply with the prevailing wage requirements, Tenant shall assure that all workers are paid the general prevailing rate of per diem wages and the general per diem prevailing rate for holiday and overtime work as defined by applicable Laws (including without limitation Labor Code Section 1773.1) in effect from time to time. Copies of the applicable prevailing rate of per diem wages are on file at Landlord's principal office and will be made available to any interested party on request. Tenant agrees to post a copy of the prevailing rate of per diem wages at the Premises. Tenant, as a penalty, shall forfeit the amount then-specified by applicable Law for each calendar day, or portion thereof (or such other sum as specified from time to time by Section 1775 of the California Labor Code or other applicable law), for each worker paid less than the applicable prevailing rates for such work or craft in which such worker is employed. Unless otherwise specified by Law, the difference between such prevailing wage rates and the amount paid to each worker for each calendar day or portion thereof for which each worker was paid less than the prevailing wage rate shall be paid to each worker by Tenant.

G. Compliance With JDA and Developer Agreement. During the initial construction of the Project, Tenant shall comply with its obligations under the JDA and Developer Agreement.

H. Insurance. See ARTICLE 9 below.

I. Utility Work. Any work performed by or on behalf of Tenant or any occupant or subtenant to connect to, repair, relocate, maintain or install any storm drain, sanitary sewer, water line, gas line, telephone conduit or any other public utility service shall be performed so as to minimize interference with the provision of such services to other property owners and occupants.

**5.8 Protection of Landlord.** Landlord shall have the right at all reasonable times to post, and keep posted, on the Premises and Premises Improvements any notices which Landlord may reasonably deem necessary for the protection of Landlord and of the Premises and Premises Improvements from mechanics' liens or other claims. Tenant shall give Landlord 10 days' prior written notice of the commencement of any Alterations that could give rise to mechanics' liens to be done on or about the Premises or Premises Improvements to enable Landlord to post such notices. In addition, Landlord may in its discretion require Tenant to furnish to Landlord at Tenant's expense reasonable improvement security, including performance and labor and materials bonds, prior to commencement of any Material Alterations. Tenant shall make, or cause to be made, prompt payment of all monies due and legally owing to all persons doing any Alterations or furnishing any materials or supplies to Tenant or any of its contractors or subcontractors in connection therewith.

**5.9 Liens and Stop Notices.** Tenant shall keep the Premises and Premises Improvements free and clear of all stop notices, mechanics' liens and other liens on account of any Alterations done for Tenant or persons claiming under it. Tenant shall indemnify and save Landlord harmless against liability, loss, damages, costs, attorneys' fees, and all other expenses on account of claims of lien of laborers or materialmen or others for Alterations performed or materials or supplies furnished to Tenant or persons claiming under it. If a claim of a lien or stop notice is given or recorded affecting the Premises or Premises Improvements,

Tenant shall have the right to consent the lien. Tenant shall, within 30 days of recording of a lien or service of a stop notice:

- A. Pay and discharge the same;
- B. Affect the release thereof by recording and delivering to Landlord a lien release bond in customary form and amount which results in the removal of such lien from the Premises and Premises Improvements; or
- C. Otherwise obtain or effect the release thereof.

**5.10 Notice.** Should any claims of lien be filed against the Premises or Premises Improvements thereon, or any action be commenced affecting the title to such property, the party receiving notice of such lien or action shall forthwith give the other party written notice thereof.

**5.11 Miscellaneous.**

A. Landlord Access. Representatives of Landlord shall have the right of reasonable access to the Premises upon reasonable notice to Tenant and without charges or fees, and at normal construction hours during any construction period, for the purposes of ascertaining compliance with the terms of this Ground Lease. Landlord's access shall be reasonably exercised to minimize interference with Tenant's construction and/or operations. In any site visits, Landlord shall comply with all safety rules of the Tenant and (except as otherwise permitted in connection with its exercise of rights under Section 6.8 below) Tenant shall have the right to accompany Landlord.

B. Guarantee of Workmanship and Materials. Tenant shall insure that any transferable warranties then in effect are transferred to Landlord upon expiration or termination of this Ground Lease.

C. Notice of Completion. Promptly upon completion of construction of the Premises Improvements and Material Alterations, Tenant shall file or cause to be filed in the Official Records of the County a Notice of Completion (the "**Notice of Completion**"), and provide a filed copy to Landlord.

D. As Built Plans and Specifications. Within 30 days following completion of construction of any construction, changes, Alteration or repair on or about the Premises for which architectural drawings and specifications are required, Tenant shall deliver to Landlord three sets (at least one of which is on CD) of "**As Built**" drawings and specifications for such work, and copies of lien waivers from all contractors, subcontractors, suppliers and materialmen involved in construction.

E. Except as otherwise expressly provided in this Ground Lease or other agreement expressly referenced herein, all Premises Improvements and Alterations shall be without cost or expense to Landlord.

**ARTICLE 6.  
USE OF PREMISES, COMPLIANCE WITH LAWS**

**6.1 General.** Tenant covenants and agrees on behalf of itself and its successors and assigns that Tenant shall continuously use and operate the Premises and Premises Improvements for the Permitted Use and for no other purpose without Landlord's prior written consent, which consent Landlord may withhold in its sole discretion. As a material condition of this Ground Lease and the City Financing Documents, Tenant shall comply and shall at all times be in compliance with the Ground Lease, the Site REA, the Hope Center REA and all Regulatory Requirements. Tenant acknowledges that Landlord has entered into this Ground Lease and has agreed to the Rent structure contained herein in material reliance on Tenant's agreement to permit only those uses described herein. In the event Tenant requests a change in any use described herein, Tenant agrees that Landlord, in its sole discretion, may withhold consent to such a request or that Landlord properly may condition consent to any change in use on a renegotiation of the Rent structure or amounts. Further, Tenant acknowledges that Landlord has determined that this use is beneficial to Landlord's overall governmental purposes and Tenant understands that, except as provided in ARTICLE 14, Landlord has no obligation to consent to any other use of all or any part of the Premises.

**6.2 Governmental Requirements.** Tenant, at Tenant's expense, shall comply with all applicable Hazardous Materials Laws (as defined in Section 7.2 below), statutes, laws, codes, rules, orders, zoning, ordinances, directions, regulations, permits, or other requirements of federal, state, county, municipal, or other governmental authorities having jurisdiction, now in force or which may hereafter be in force (individually "**Law**" and collectively "**Laws**"), which shall impose any duty upon Landlord or Tenant with respect to the use, occupancy, or alteration of the Premises or Premises Improvements or any portion thereof, including those requiring alterations or additions to be made to, or safety appliances or devices to be maintained or installed in, on or about the Premises or Premises Improvements or any portion thereof, and payment of any fees, charges or assessments arising out of or in any way related to the Premises or Premises Improvements or any portion thereof as a source of adverse environmental impacts or effects].

**6.3 Tenant's Right to Contest.** Tenant, at its sole cost and expense, shall have the right to contest, by appropriate proceedings diligently conducted in good faith in the name of Tenant, the validity or application of any applicable Law. If compliance with any applicable Law legally may be delayed pending the prosecution of any such proceeding without cost or penalty and without subjecting Landlord to any liability, civil or criminal, Tenant may delay compliance until the final determination of such proceeding.

**6.4 Nuisance.** Tenant shall not use the Premises or the Premises Improvements for any unlawful purpose and shall not perform, permit or suffer any act of omission or commission upon or about the Premises or the Premises Improvements which would result in a nuisance or a violation of the laws and ordinances of the United States, State, County or City ordinances and all agencies thereof as the same may be now or hereafter in force and effect. Landlord understands and agrees that Tenant's residential subtenants or clients may populate and congregate on the sidewalk adjacent to or near the Premises, and may make noise when arriving at or waiting to enter the Premises Improvements. Whether or not any otherwise legal activities of the Tenant's subtenants and clients constitute a legal nuisance, they will not constitute a default justifying termination of this Lease under ARTICLE 13.

**6.5 General Use Prohibitions.** Tenant covenants and agrees that in connection with the use and operation of the Premises and Premises Improvements, and any portion thereof, Tenant will not:

A. Permit undue accumulations of garbage, trash, rubbish or any other refuse;

B. Create, cause, maintain or permit any nuisance (as the same may be defined by Law) in, on or about the Premises or Premises Improvements;

C. Commit or suffer to be committed any waste in, on or about the Premises or Premises Improvements;

D. Use or allow the Premises or Premises Improvements to be used for any unlawful purpose, or for any purpose which violates the terms of any recorded instrument affecting the Premises;

E. Cause or permit any insurance coverage on the Premises or Premises Improvements to become void or voidable or make it impossible to obtain any required insurance at commercially reasonable rates;

F. Intentionally cause or knowingly permit any material structural damage to or deterioration of the Premises or Premises Improvements or to any adjacent public or private property or improvements; or

G. Violate or permit any violation of any applicable Law, ordinance or regulation applicable to the Premises or Premises Improvements.

**6.6 Non-Discrimination.** Tenant covenants and agrees that there shall be no unlawful discrimination against or segregation of any person or group of persons on account of race, color, creed, religion, sex, marital status, sexual orientation, source of income, age, physical or mental handicap, medical condition, national origin or ancestry in the sublease, transfer, use, occupancy, tenure or enjoyment of the Premises, the Premises Improvements or any portion thereof, nor shall Tenant, or any person claiming under or through Tenant, establish or permit any such unlawful practice or practices of discrimination or unlawful segregation with reference to the selection, location, number, use or occupancy of tenants, lessees, sublessees, subtenants, vendees, users or customers in the Premises, the Premises Improvements, or any portion thereof. Tenant shall refrain from unlawfully restricting the use, occupancy, rental or sublease of the Premises, the Premises Improvements, or any portion thereof on account of race, color, creed, religion, sex, marital status, sexual orientation, source of income, age, physical or mental handicap, medical condition, national origin or ancestry of any person. City understands and agrees that the shelter beds in the Temporary Housing Improvements may be restricted to men, or persons identifying as men.

**6.7 General Standards of Maintenance.** Tenant covenants and agrees that it shall maintain, or cause to be maintained, the Premises, the Premises Improvements, and all improvements and landscaping within the Premises in a good, safe condition and repair, subject only to normal wear and tear, and in full compliance with Site REA, the Hope Center REA all applicable Laws, and this Ground Lease.. To accomplish such maintenance, Tenant shall either staff or contract with and hire licensed and qualified personnel to perform such maintenance work, including the provision of labor, equipment, materials, support facilities, and

any and all other items necessary to comply with the requirements of this Section. All maintenance work shall conform to all applicable Federal and State Occupation Safety and Health Act standards and regulations for the performance of maintenance.

**6.8 Landlord's Status as a Landowner.** Tenant understands and agrees that Landlord is entering into this Ground Lease in its capacity as a landowner with a proprietary interest in the Premises and Premises Improvements and not as a regulatory authority with certain police powers. Landlord's legal status shall in no way limit the obligation of Tenant to obtain any required approvals from Landlord's departments, boards or commissions that have jurisdiction over the Premises or Premises Improvements. By Landlord's entering into this Ground Lease, neither Landlord nor any of Landlord's Council, boards, commissions, agencies, departments, or affiliates obligates itself to any other governmental agent, board, commission or agency, or to Tenant, or to any other individual or entity, with regard to any discretionary action relating to development or operation of the Premises, or Premises Improvements. Discretionary action includes but is not limited to rezonings, variances, environmental clearances, or any other governmental agency approvals that may be required or desirable for the improvement, alteration, or operation of the Premises, or Premises Improvements by the City in connection with its governmental capacity or police powers. By entering into this Ground Lease, Landlord is in no way modifying or limiting the obligation of Tenant to cause the Premises and Premises Improvements to be used and occupied in accordance with all Laws, nor any right of the Landlord or its Council, boards, commissions, agencies, departments, or affiliates to directly enforce Tenant's compliance with Laws. Further, nothing in this Ground Lease shall subject Landlord to liability or increase its liability in connection with any act, omission, occurrence or circumstance arising from its governmental capacity or police powers due to its status as Landlord under this Ground Lease.

**6.9 Regulatory Approvals Generally.** Tenant acknowledges and agrees that this Ground Lease does not guarantee that Landlord, in its regulatory capacity, will grant any particular request for a license, permit or other regulatory approval. Tenant understands that Landlord may grant or deny such request in its sole discretion, and may impose such terms and conditions as it deems consistent with that discretion and applicable Laws.

## ARTICLE 7.

### CONDITION OF PREMISES; HAZARDOUS MATERIALS; LANDLORD'S RIGHT OF ENTRY

**7.1 Landlord's Disclaimers and Tenant's Acknowledgements.** The Premises are being leased to Tenant in their current, existing, "AS-IS" condition as set forth in, and subject to, DDA Section 4.5, the terms of which are incorporated herein by reference, except that all references therein to "Developer" are replaced with "Tenant".

#### **7.2 Hazardous Materials**

A. General Compliance. DDA Section 6.2, the terms of which are incorporated herein by reference, with the following modifications in addition to the other modifications therein:

1. All references therein to "Developer" are replaced with "Tenant";
2. All references to "Hazardous Materials Laws" shall mean all laws, codes, rules, orders, ordinances, directives, regulations, permits, or other requirements of federal, state, county, municipal or governmental authorities having jurisdiction, now in force or

which may hereafter be in force concerning the management, use, generation, storage, transportation, presence, discharge or disposal of any and all pollutants, wastes, flammables, explosives, radioactive materials, hazardous or toxic materials, hazardous or toxic wastes, hazardous or toxic substances, carcinogenic materials or contaminants and all other materials governed, monitored, or regulated by any Federal, State or local law or regulation, including but not limited to the Comprehensive Environmental Response, Compensation and Liability Act, the Hazardous Substances Account Act, and/or the Resources Conservation and Recovery Act.

3. All references to “**Hazardous Materials**” shall include asbestos, asbestos-containing materials, hydrocarbons, polychlorinated biphenyl (“**PCB**”) or PCB-containing materials, petroleum, gasoline, petroleum products, crude oil or any fraction, product or by-product thereof.

4. All references to "Development" means the "Premises."

5. All references to “Term” shall mean “Term” as defined in this Ground Lease.

6. Nothing in this Ground Lease or **Exhibit C** shall limit or restrict the use of limited quantities of household cleaning products and office supplies used or stored at the Premises and required in connection with the routine operation and maintenance of the Premises, and used in compliance with (i) this Ground Lease, (ii) all applicable Hazardous Materials Laws, and (if applicable) (ii) the Project Rules (as defined in the Site REA) and the Hope Center Project Rules (as defined in the Hope Center REA).

B. Tenant’s Independent Investigation. Tenant or its agents and representatives have undertaken investigations of the Premises in an attempt to determine if any Hazardous Material is present on the Premises. Except as disclosed in the Phase I and Phase II Environmental Assessment report dated \_\_\_\_\_, 2018 by Rincon Consultants, and *[insert name/other information regarding additional soils testing, expected to be completed on or about December 2019]*, no Hazardous Material has been located or discovered to date and the parties agree that for purposes of this Ground Lease, Tenant assumes full responsibility for the investigation and remediation, as and to the extent required by Environmental Laws, of all Hazardous Material in, on or under the Premises that is discovered during the Term.

### **7.3 Landlord’s Right to Enter Premises and Premises Improvements.**

Landlord and its authorized representatives shall have the right to enter the Premises and Premises Improvements at all reasonable times, after giving Tenant 24 hours prior written notice (except in emergency in which case no notice shall be required), for any purpose, including: to determine whether the Premises, the Premises Improvements, or any other improvements on the Premises is in good condition and whether Tenant is complying with its obligations under this Ground Lease; to do any necessary maintenance and to make any restoration to the Premises Improvements or any other improvements upon the Premises that Landlord has the right or obligation to perform; to serve, post or keep posted any notices required or allowed under the provisions of this Ground Lease and (except as otherwise permitted in connection with its exercise of rights under Section 6.8 above) Tenant shall have the right to accompany Landlord.

A. Landlord shall not be liable in any manner for any inconvenience, disturbance, loss of business, nuisance, or other damage arising out of Landlord’s entry on the

Premises and Premises Improvements as provided in this Section other than any property damage, bodily injury, or death caused by the sole active negligence or willful misconduct of Landlord, its agents, employees or contractors.

B. Tenant shall not be entitled to an abatement or reduction of Rent if Landlord exercises any rights reserved in this section.

**ARTICLE 8.  
OWNERSHIP OF IMPROVEMENTS AND  
PERSONAL PROPERTY**

**8.1 Ownership of Premises Improvements During Term.** During the Term, the Premises Improvements and Alterations shall be and remain the property of Tenant; provided that Tenant's rights and powers with respect to the Premises Improvements and any Alterations shall be and shall remain subject to the terms and limitations of this Ground Lease. Tenant covenants for itself and all persons claiming under or through it that the Premises Improvements is and will at all times be real property.

**8.2 Ownership of Premises Improvements at Termination or Expiration.** Upon the expiration or other termination of this Ground Lease, all improvements on the Premises, including the Premises Improvements and any Alterations shall, without compensation to Tenant, become Landlord's property free and clear of all claims to or against to the extent caused by Tenant or subtenant. Tenant is not obligated to remove rights arising from the Site REA and Hope Center REA. (See also Section 15.10.)

**8.3 Removal and Ownership of Personal Property at Termination or Expiration.** At the expiration or termination of the Term, Landlord may, at Landlord's election, require Tenant to remove from the Premises, at Tenant's sole cost and expense, all personal property (including fixtures). Tenant shall be liable to Landlord for costs incurred by Landlord in effecting the removal of such personal property (including fixtures) which Tenant has failed to remove after demand pursuant to this section.

A. Tenant and other permitted occupants may, from time to time during the Term, remove any personal property (other than fixtures) that may be removed without damage to the structural integrity of the Premises or Premises Improvements. Tenant shall (or shall cause its other permitted occupants to) repair all damage caused by any such removal.

B. Any personal property owned by Tenant or its subtenants and not removed by Tenant prior to the expiration or termination of the Term shall be deemed to be abandoned by Tenant or (to the greatest extent permitted by applicable Law) its subtenants, and shall, without compensation to Tenant or (to the extent permitted by applicable Law) subtenant, become the Landlord's property, free and clear of all claims to or against them by Tenant, subtenant or any other person, but subject to the rights of third party lenders and equipment lessors as to which Landlord has notice.



**ARTICLE 9.  
INSURANCE AND INDEMNITY**

**9.1 General Insurance Requirements.**

A. During the entire Term of this Ground Lease, Tenant shall provide the following forms and amounts of insurance with respect to the Premises Improvements and the Premises. Such insurance shall be primary to and not contributing with any other insurance, self-insurance, or joint self-insurance maintained by the Landlord, shall name the Landlord as an additional insured, and shall include, but not be limited to:

1. Fire and Extended Coverage Insurance as provided the Site REA or, following the expiration or termination thereof, as Landlord may reasonably specify..

2. Broad Form Commercial General Liability Insurance in an amount not less than \$2,000,000 per occurrence and umbrella/excess liability insurance in the amount of \$5,000,000, as further provided the Site REA and this ARTICLE 9 or, following the expiration or termination thereof, as Landlord may reasonably specify. The policy shall not contain any intra-insured exclusions as between insured persons or organizations, but shall include coverage for liability assumed under this Ground Lease as an “insured contract” for the performance of Tenant’s indemnity obligations under this Ground Lease. The limits of this insurance shall not, however, limit the liability of Tenant nor relieve Tenant of any obligation hereunder. .

3. Comprehensive Auto Liability Insurance with limits not less than \$2,000,000 each occurrence as further provided the Site REA and this ARTICLE 9 or, following the expiration or termination thereof, as Landlord may reasonably specify.

4. Worker’s Compensation Insurance, including Employer’s Liability coverage, with limits not less than \$1,000,000 each accident, to the extent required by law, as may be further provided the Site REA and this ARTICLE 9 or, following the expiration or termination thereof, as Landlord may reasonably specify.

5. Leasehold Mortgagee Insurance. Any additional policy of insurance required by any lender providing permanent financing for the Premises Improvements or any Alterations.

B. Review. The liability insurance requirements may be reviewed by Landlord every five years, for the purpose of increasing (in consultation with its insurance advisors) the minimum limits of such insurance from time to time to limits which shall be reasonable and customary for similar facilities of like size and operation in accordance with generally accepted insurance industry standards, but in no event will Tenant be required to increase the amount of cumulative or single occurrence coverage for any five-year period by more than the lesser of (i) 50% and (ii) two times the CPI increase since the last increase under this Section.

C. Insurance for Construction of Premises Improvements and Alterations. Tenant’s contractors and subcontractors for the Premises Improvements shall maintain all insurance required by DDA Section 6.3(b). Tenants contractors and subcontractors for any Alterations shall maintain all liability, property worker’s compensation, employee and insurance as Landlord deems reasonably necessary or as otherwise provided in this Ground Lease.

D. General. All deductibles shall be declared to and subject to Landlord's approval if in excess of \$100,000 per occurrence (as increased by CPI). All commercial general liability and automobile liability policies shall name Landlord and its officers, agents, employees, and representatives (together, "**Landlord Parties**") as additional insureds. Tenant shall furnish Landlord with a certificate of insurance evidencing the required insurance coverage and a duly executed endorsement evidencing such additional insured status. The certificate shall (to the extent reasonably obtainable) contain a statement of obligation on the part of the carrier to notify Landlord of any material change, cancellation or termination of the coverage at least 30 days in advance of the effective date of any such material change, cancellation or termination; otherwise, Tenant shall provide such notice. Upon Landlord's request, Tenant shall provide certified copies of all insurance policies, including declarations pages. Coverage provided hereunder by Tenant or its contractors shall be primary insurance and shall not be contributing with any insurance, self-insurance or joint self-insurance maintained by Landlord, and the policy shall so provide. The insurance policies shall contain a waiver of subrogation for the benefit of the Landlord and other additional insureds. The required certificate and endorsements shall be furnished by Tenant to Landlord prior to the Ground Lease Date, and prior to each anniversary thereof. If Tenant or its contractors fails to purchase, renew or maintain any insurance policies required herein, Landlord shall have the right to so purchase any such insurance and the amount of any such advance by Landlord shall constitute Additional Rent under this Ground Lease.

**9.2 Indemnity.** To the greatest extent permitted by Law (including without limitation Civil Code Section 2782 if and to the extent applicable), Tenant shall protect, indemnify, defend and hold Landlord and Landlord Parties harmless from and against any and all demands, liability, claims, actions and damages to any person or property, costs and expenses, including attorneys' fees, arising out of or connected with: (i) a default by Tenant of its obligations under this Ground Lease; (ii) the use or occupancy of the Premises Improvements, the Premises, the improvements thereon including any Alterations, or any portion thereof, by Tenant or any of its contractors, subcontractors, employees, subtenants, licensees, invitees, subtenants, assignees or Users (collectively "**Tenant's Parties**"), other than those attributable to the sole negligence or willful misconduct of Landlord or Landlord Parties; (iii) any pre-Ground Lease Date entry by or on behalf of Developer or Tenant under the Temporary Right of Entry described in DDA Section 9.19(a); and (iv) the release, use, generation, discharge, storage or disposal of any Hazardous Materials on, under, in or about, or the transportation of any such Hazardous Materials to or from, the Premises in violation, or alleged violation, of any Laws, which occurs at any time during the Term. The indemnity obligation in clause (iii) above shall include any demands, liability, claims or actions for tangible or intangible property damage; compensation for lost wages, business income, profits or other economic loss; damage to the natural resource or the environment; nuisance; trespass; and/or contamination, leak, spill, release or other adverse effect on the environment. Tenant's indemnity obligations under this Section shall survive the expiration or termination of this Ground Lease.

## **ARTICLE 10. DAMAGE OR DESTRUCTION**

### **10.1 Restoration.**

A. Insured Damage. No loss or damage by fire or any other cause resulting in either partial or total destruction of the Premises Improvements or any other improvements now or hereafter located on the Premises, including any fixtures, personal property, equipment or machinery used or intended to be used in connection with the Premises or Premises

Improvements, shall (except as otherwise provided in Sections 1.1A or 10.1B) operate to terminate this Ground Lease or to relieve or discharge Tenant from the payment of any Rent, or other amounts payable hereunder, as and when they become due and payable, or from the performance and observance of any of the agreements, covenants and conditions herein contained to be performed and observed by Tenant. Provided that Tenant determines that it is feasible to repair the Premises Improvements, and subject to the rights of Leasehold Mortgagees and Tenant's Investors, and specific procedures (if any) set forth in the Site REA, Tenant covenants to repair, reconstruct, and/or replace or cause to be repaired, reconstructed and/or replaced the Premises Improvements and any other improvements now or hereafter located on the Premises, including any fixtures, personal property, equipment or machinery used or intended to be used in connection with the Premises or Premises Improvements, so damaged or destroyed. Subject to the rights of any Leasehold Mortgagee, Tenant also covenants that all insurance proceeds will be applied to the repair, reconstruction and/or replacement described herein.

B. Premises Improvements Uninsured Damage. Notwithstanding the provisions of Section 10.1A, if, during the Term, the Premises Improvements are totally destroyed or rendered inaccessible or if the remaining portion of the Premises Improvements are rendered unsuitable (as defined herein) for Tenant's continued use, from a risk not covered 90% by the insurance required to be carried by Tenant under this Ground Lease, and either (i) the cost of restoration exceeds 50% of the then replacement value of the Premises Improvements as reasonably determined by Landlord, (ii) Tenant reasonably determines that repair and reconstruction is infeasible, or (iii) if fewer than fifteen (15) years of the Term remain, Tenant can elect to terminate this Ground Lease by giving notice to Landlord within 30 days after Landlord's determination of the restoration cost and replacement value. The Premises Improvements shall be deemed unsuitable for Tenant's continued use if, following a reasonable amount of reconstruction, Tenant's operations in the Premises Improvements could not be maintained at an economically feasible level. Subject to the rights of Leasehold Mortgagees and Tenant's Investors, if this Ground Lease terminates pursuant to this Section, Tenant shall surrender possession of the Premises and, subject to the rights of Leasehold Mortgagees and Tenant's Investors, assign to Landlord its rights and interests in and to the proceed of insurance received by Tenant for the repair or demolition of the Premises Improvements.

C. Loss Adjustment and Disbursement Procedures. Except as may otherwise be required by any Leasehold Mortgagee, Tenant shall make the loss adjustment with the insurance company insuring the loss. Except as may otherwise be required by any Leasehold Mortgagee and Tenant's Investors, all resulting insurance proceeds shall be held for the following purposes:

1. The sums shall be paid in installments by the contractor retained by Tenant as construction progresses, for payment of the cost of restoration. Any final retention provided for in the contract with such contractor will be paid to the contractor on completion of restoration, payment of all costs, expiration of all applicable lien periods, and proof that the restored Improvements and the Premises are free of all mechanics' liens and lienable claims.

2. Payments shall be made on presentation of certificates or vouchers from the architect or engineer retained by Tenant showing the amount due. If Landlord, in its reasonable discretion, determines that the certificates or vouchers are being improperly approved by the architect or engineer retained by Tenant, Landlord shall have the right to appoint a project manager to supervise construction and to approve payments on certificates or vouchers approved by the architect or engineer retained by the Tenant. The

reasonable expenses and charges of the project manager retained by Landlord shall be paid from the insurance proceeds.

3. If at any time it reasonably appears to Tenant that the sums held by the Tenant are not sufficient to pay the actual cost of restoration, Tenant shall identify the amount of the deficiency to Landlord as promptly thereafter as reasonably possible.

4. Any undisbursed funds after compliance with the provisions of this Section 10.1C shall be delivered to Landlord to the extent of Landlord's contribution to the fund, and the balance, if any, shall be paid to Tenant.

**10.2 Waiver.** The provisions of this ARTICLE 10 shall govern the rights of the parties in the event of any full or partial destruction of the Premises Improvements and any improvements thereon. Tenant hereby waives the provisions of Civil Code Section 1932(2) and Civil Code Section 1933(4) and any similar successor statute or Law with respect to any destruction of the Premises Improvements.

**10.3 Determination of Extent of Destruction, Interference with Use.** For purposes of this ARTICLE 10, the extent of destruction of the Premises Improvements shall be determined by dividing the estimated cost of replacement or restoration as evidenced by estimates prepared by licensed general contractors acceptable to Landlord for the full replacement cost of the Premises Improvements, as reasonably determined by Landlord, Tenant and (to the extent required by the applicable insurance policies) Tenant's insurers.

**10.4 Procedures for Repair and Restoration.** Tenant shall promptly give Landlord reasonable written notice in the event of any damage or destruction to either (i) the Premises Improvements or (ii) (to the extent of Tenant's actual knowledge) the entire Development, with an estimated restoration cost exceeding \$1,000,000 (subject to adjustment pursuant to the CPI from and after the Ground Lease Date). Tenant's notice shall include the general nature of the damage or destruction and the date on which it occurred. Regardless of the amount of any damage or destruction, Tenant shall promptly make proof of loss and shall proceed promptly to collect, or cause to be collected, all valid claims which Tenant may have against insurers or others based upon any such damage or destruction. Except as otherwise provided above and subject to rights of Leasehold Mortgagees and Investors, amounts received on account of any losses pursuant to insurance policies shall be used and expended for the purpose of fully repairing or reconstructing the portions of the Premises Improvements which have been destroyed or damaged (or repaying loans or advances used for such purposes).. Tenant shall commence and complete or cause to be commenced and completed any repairs and reconstruction in a good and workmanlike manner and in accordance with the Site REA, this ARTICLE 10 and the applicable provisions of ARTICLE 5 above.

## ARTICLE 11. CONDEMNATION

### 11.1 Definitions.

A. "Condemnation" means: (1) the exercise of any governmental power in eminent domain, whether by legal proceedings or otherwise, by a condemnor, and (2) a voluntary sale or transfer to any condemnor, either under threat of condemnation or while legal proceedings for condemnation are pending.

B. **“Date of taking”** means the date the condemnor has the right to possession of the property being condemned.

C. **“Award”** means all compensation, sums or anything of value awarded, paid or received on a total or partial condemnation.

D. **“Condemnor”** means any public or quasi-public authority, or private corporation or individual, having the power of condemnation.

**11.2 Parties’ Rights and Obligations to be Governed by Ground Lease.** If during the Term there is any taking of all or any part of the Premises, the Premises Improvements or any other improvements on the Premises or any interest in this Ground Lease by condemnation, the rights and obligations of the parties shall be determined pursuant to the provisions of this ARTICLE 11.

**11.3 Total Taking.** If the Premises or Premises Improvements are totally taken by condemnation, this Ground Lease shall terminate on the date of taking.

**11.4 Effect of Partial Taking.** If a portion of the Premises Improvements or Premises or any other improvements thereon are taken by condemnation, this Ground Lease shall remain in effect, except that Tenant may elect to terminate this Ground Lease if the remaining portion of the Premises or Premises Improvements are rendered unsuitable (as defined herein) for Tenant’s continued use. The remaining portion of the Premises Improvements or the Premises shall be deemed unsuitable for Tenant’s continued use if, following a reasonable amount of reconstruction, Tenant’s operations in the Premises Improvements could not be maintained at an economically feasible level. Tenant must exercise its right to terminate by giving Landlord written notice of its election within 90 days after the nature and extent of the taking have been finally determined. Such notice shall also specify the date of termination, which shall not be prior to the date of taking. Failure to properly exercise the election provided for in this Section 11.4 will result in this Ground Lease continuing in full force and effect.

**11.5 Restoration of Premises Improvements.** If in Tenant’s judgment it is reasonably possible and economically feasible to do so, Tenant shall be entitled to use that portion of the award allocable to the Premises Improvements as is necessary to restore or to add on to the Premises Improvements so that the area and approximate layout of the Premises Improvements will be substantially the same after the date of taking as it was before the date of taking. If it is not reasonably possible and economically feasible to so restore the area and layout of the Premises Improvements, the remaining provisions of this ARTICLE 11 shall govern the rights of the parties. If Tenant fails to promptly commence any reasonably required repair, restoration or reconstruction of the Premises Improvements and diligently prosecute such repair, restoration or reconstruction to completion, and such failure is not remedied within 30 days of written notice from the Landlord to Tenant, this Ground Lease may be terminated by the Landlord.

**11.6 Waiver of CCP Section 1265.130.** Each party waives the provisions of the Code of Civil Procedure Section 1265.130 allowing either party to petition the Superior Court of the County of Alameda, State of California to terminate this Ground Lease in the event of a partial taking of the Premises.

**11.7 Award.** Subject to the provisions of Section 11.5, and subject to the rights of Leasehold Mortgagees and Investors, if all or any portion of the Premises Improvements or any other improvements on the Premises is taken in connection with a condemnation, the award for the Premises Improvements or such other improvements shall be allocated taking into account that the Landlord's interest is limited to the land or air space (exclusive of the Premises Improvements). If the Premises Improvements are to be restored pursuant to Section 11.5 above, Tenant shall be entitled to recover the costs and expense incurred in such restoration out of any condemnation proceeds. Thereafter, if the condemning authority does not make separate awards, the proceeds will be allocated on a proportionate basis. If Landlord and Tenant are unable to agree as to the amounts that are to be allocated to each other, the allocation will be determined by an appraisal performed by a mutually agreed appraiser. The appraiser shall separately determine the amount of award to be allocated to the interest of each party, and the costs of the appraiser shall be borne equally by each party.

## **ARTICLE 12. ASSIGNMENT AND SUBLETTING**

### **12.1 Assignment.**

A. Except as provided in Section 1.6 and the Lease Transfer Agreement, Tenant shall not assign, sublet or otherwise transfer, whether voluntarily or involuntarily or by operation of Law, this Ground Lease, the Premises Improvements or any part thereof (collectively an “**assignment**”) without Landlord's written consent, which shall not unreasonably be withheld, conditioned or delayed. The merger of Tenant with any other entity or the assignment or transfer of any direct or indirect controlling or managing ownership interest in Tenant, or the assignment or transfer of a substantial portion of the assets of Tenant, whether or not located at the Premises, or any interest in the Premises Improvements, shall constitute an “assignment” hereunder. However, the transfer of a limited partnership interest in a limited partnership tenant, or of a non-managing membership interest in a limited liability company tenant, shall not constitute an assignment.

B. Notwithstanding Subsection 12.1A above, Landlord's consent is not required for any assignment to an Affiliate (as defined below) of BRIDGE or BFHP, as long as the following conditions are met: (i) Landlord receives written notice of the assignment (as well as any documents or information reasonably requested by Landlord regarding the assignment or assignee); and (ii) the assignee assumes in writing all of Tenant's obligations under this Ground Lease. For purposes of this Section, “**Affiliate**” means an entity which controls, is controlled by or under common control with Tenant. For the purposes of this definition, “control” means the direct or indirect ownership of more than 50% of the voting securities of an entity or possession of the right to direct the entity's day-to-day affairs.

C. Also notwithstanding Subsection 12.1A above, Landlord's consent is not required for any assignment to an Investor, as long as the following conditions are met: (i) the assignment occurs pursuant to the term of Tenant's governing documents, following a default to the Investor; (ii) Landlord receives written notice of the assignment (as well as any documents or information reasonably requested by Landlord regarding the assignment or assignee); and (iii) the Investor assumes in writing all of Tenant's obligations under this Ground Lease.

D. No partial assignments of this Ground Lease shall be permitted, and all assignments must be accompanied by a concurrent transfer of the Premises Improvements to the assignee. Assignments of this Ground Lease shall only be made pursuant to a written

assignment and assumption agreement in a form reasonably acceptable to Landlord. Landlord's consent to any one assignment shall not constitute consent to any other assignment, and shall not constitute a waiver of the right to give or withhold consent in accordance with this Section 12.1.

E. In the event Tenant shall assign this Ground Lease or request the consent of Landlord to any assignment for which Landlord's consent is required under this ARTICLE 12, then Tenant shall pay Landlord's reasonable attorneys' fees incurred in connection with each such request.

**12.2 Subleases.** Except as provided in Subsection 1.6B, to residential tenants and other tenants typically entered into in connection with residential development (such as laundry leases) and subject to all Regulatory Requirements, Tenant shall not sublease all or any portion of the Premises Improvements or the Premises without Landlord's prior written consent, which may be withheld for any reason whatsoever in Landlord's sole absolute discretion. No permitted subletting shall limit Tenant's obligations under this Lease.

### **ARTICLE 13. TENANT DEFAULTS AND LANDLORD'S REMEDIES**

**13.1 Defaults by Tenant.** Tenant shall be in default under this Ground Lease upon occurrence of any of the following:

A. Tenant shall at any time be in default in the payment of Rent or any other monetary sum called for by this Ground Lease for more than 30 days following written notice from Landlord to Tenant; or

B. Tenant shall at any time be in default in the keeping and performing any of its covenants or agreements contained in the Regulatory Requirements, Site REA or Hope Center REA, and such other default continues for 30 days after written notice thereof from Landlord to Tenant specifying the particulars of such default, or if such default is of a nature that curing such default will take more than 30 days Tenant has failed to commence such cure within such 30-day period and to thereafter diligently and continuously pursue completion of such cure, provided that such cure period need not exceed any time period that the failure to cure would result in Landlord itself being in violation of any Law or expose Landlord to unreasonable financial risks; or

C. Tenant shall at any time be in default in the keeping and performing of any of its other covenants or agreements contained in this Ground Lease, and should such other default continue for 30 days after written notice thereof from Landlord to Tenant specifying the particulars of such default, or if such other default is of a nature that curing such default will take more than 30 days Tenant has failed to commence such cure within such 30-day period and to thereafter diligently and continuously pursue completion of such cure; or

D. Tenant abandons or substantially suspends the Premises Improvements prior to completion thereof and such default is not cured within 60 days of written notice from Landlord to Tenant; or

E. Tenant assigns, sells, transfers, conveys, encumbers, hypothecates or leases the whole or any part of the Premises Improvements, the Premises, or any other improvement constructed thereon in violation of the Improvements Documents; or

F. Except as otherwise expressly permitted in this Ground Lease there is any change in control of Tenant, or any other act or transaction involving or resulting in a change in the identity of the parties in control of Tenant or the degree of such control; or

G. Subject to ARTICLE 14 below, Tenant defaults on any loan encumbering Tenant's interest in this Ground Lease or any improvements on the Premises for which Tenant is responsible, and such failure continues beyond (i) the expiration of any applicable grace or cure period, and (ii) the date by which Tenant must make payment to cure any notice of default received from the holder of such loan; or

H. Any Leasehold Mortgagee or any other holder of any private loan encumbering Tenant's interest in this Ground Lease, or any improvements on the Premises initiates a foreclosure of the deed of trust by which such loan is secured, and Tenant fails to cause such foreclosure proceedings to be dismissed prior to the earlier to occur of (i) the trustee under the deed of trust giving notice of the trustee's sale, or (ii) within 30 days of Tenant's receipt of written notice from Landlord.

**13.2 Remedies.** Subject to the rights of any Leasehold Mortgagees permitted under ARTICLE 14, upon the occurrence of any such default, in addition to any and all other rights or remedies of Landlord hereunder, or by Law or in equity provided, Landlord shall have the sole option to exercise the following rights and remedies:

A. Terminate this Ground Lease by giving Tenant notice of termination. On the giving of such notice, all of Tenant's rights in the Premises, Premises Improvements and any other improvements located thereon, shall terminate. Immediately following notice of termination, Tenant shall surrender and vacate the Premises, including the Premises Improvements and any other improvements located thereon, leaving them in broom-clean condition; and, subject to Subsection 13.2B below, respecting the right of certain subtenants to remain, Landlord may reenter and take possession of the Premises and Premises Improvements and eject all parties in possession or eject some and not others, or eject none. Termination under this subsection shall not relieve Tenant from the payment of any sum then due to Landlord or from any claim for damages previously accrued or then accruing against Tenant.

B. Without terminating this Ground Lease, Landlord may at any time and from time to time relet the Premises, including the Premises Improvements, or any part or parts thereof for the account and in the name of Tenant or otherwise. Any reletting may be for the remainder of the Term or for a longer or shorter period, and subject to the rights of any subtenant under subleases permitted under Section 12.2. Landlord may execute any leases made under this provision either in Landlord's name or in Tenant's name, and shall be entitled to all rents from the use, operation, and occupancy of the Premises, Premises Improvements and any other improvements thereon. Tenant hereby appoints Landlord its attorney-in-fact for purpose of such leasing. Tenant shall nevertheless pay to Landlord on the due dates specified in this Ground Lease the equivalent of all sums required of Tenant under this Ground Lease, less the revenue received by Landlord from any reletting or attornment, plus Landlord's reasonable expenses, including (by way of example), but not limited to, remodeling expenses, Landlord's brokerage and advertising costs and attorneys' fees and costs. No act by or on behalf of Landlord under this subsection shall constitute a termination of this Ground Lease unless Landlord gives Tenant written notice of termination, and Tenant shall remain liable for all costs, losses and damages resulting from unperformed Tenant obligations and breaches under permitted subleases.



C. Even though Landlord may have relet all or any portion of the Premises, including the Premises Improvements and any other improvements thereon, Landlord may thereafter elect to terminate this Ground Lease and all of Tenant's rights in or to the foregoing.

**13.3 Damages.** Neither party shall be entitled to recover consequential or punitive damages under this Lease.

**13.4 Landlord's Right to Cure Tenant's Default.** Landlord, at any time after Tenant commits a default which Tenant has failed to cure within the time established therefor, may cure the default at Tenant's cost. If Landlord at any time, by reason of Tenant's default, pays any sum, the sum paid by Landlord shall be due immediately from Tenant to Landlord at the time the sum is paid, and if paid at a later date, shall bear interest at the Interest Rate from the date the sum is paid by Landlord until Landlord is reimbursed by Tenant. The sum, together with interest thereon, shall be Additional Rent.

**13.5 Guarantor Performance Under Completion Guaranty.** Notwithstanding anything in this Ground Lease to the contrary (other than the last sentence of this Section 13.5), (i) if Landlord enforces its rights against Guarantor, Guarantor's performance in compliance with the Completion Guaranty shall be deemed to suspend any default by Tenant under this Ground Lease relating to the construction of the Premises Improvements, and Landlord shall accept Guarantor's performance thereof; and (ii) so long as the Guarantor proceeds diligently to perform the guaranteed obligations thereunder (subject to permitted force majeure delays and other delays expressly specified in the Completion Guaranty) and to cause the Premises Improvements to be completed within three years following the date completion is otherwise required under this Ground Lease, Landlord shall not exercise any of its remedies under the Ground Lease arising from the Tenant's failure to construct the Premises Improvements as required herein including, without limitation, termination of this Ground Lease. Nothing in this Section 13.5 shall limit Landlord's right to collect any amounts otherwise due under Section 13.4 following Guarantor's satisfaction of all obligations under the Completion Guaranty or Guarantor's default thereunder.

## ARTICLE 14. MORTGAGEE PROTECTION PROVISIONS

**14.1 Right to Encumber.** Tenant shall have the right during the Term to encumber, through one or more Leasehold Mortgages and the Regulatory Requirements, all of Tenant's right, title and interest in the Premises, subject to the provisions of this Ground Lease; provided, however, that any Leasehold Mortgage shall be in all respects subordinate and inferior to Landlord's right, title and interest as fee title owner of the Site and Premises, and any such Leasehold Mortgagee shall be subject to all of the rights and obligations of Landlord herein contained in this Ground Lease, except as otherwise provided in this Ground Lease. For purposes of this Ground Lease, Landlord and Tenant acknowledge and agree that the Senior Leasehold Mortgagee identified on **Exhibit F** attached hereto is a permitted Leasehold Mortgagee and all references to a "Leasehold Mortgagee" shall specifically include Senior Leasehold Mortgagee. All references to a Leasehold Mortgage shall include, without limitation, that certain Construction Leasehold Deed of Trust, Security Agreement, Assignment of Leases and Rents and Fixture Filing, dated as of even date herewith, made by Tenant for the benefit of the initial Senior Leasehold Mortgagee. For so long as any Leasehold Mortgage is outstanding, Landlord shall not agree to any mutual termination or accept any surrender of this Ground Lease without the prior written consent of the holders of Leasehold Mortgages then in effect, and any such termination or surrender without such consent shall have no force or effect.

**14.2 Leasehold Mortgagee as Third Party Beneficiary.** Notwithstanding anything to the contrary contained herein, a Leasehold Mortgagee shall be deemed to be a third party beneficiary of Tenant's obligations under this Ground Lease; provided that the foregoing shall not alter any right, remedy, duty or obligation between Tenant and Landlord herein.

**14.3 Notice to Leasehold Mortgagee.** During any period in which a Leasehold Mortgage is in place, Landlord shall give any such Leasehold Mortgagee of which Landlord has received notice from Tenant a duplicate copy of all notices of default or other notices that Landlord may give to or serve in writing upon Tenant pursuant to the terms of this Ground Lease. The address of the Leasehold Mortgagee originally designated in the Leasehold Mortgage may be changed upon written notice delivered to Landlord in the manner specified in Section 15.5 below. Landlord's failure to give any such notice to any such Leasehold Mortgagee shall not render such notice ineffective, nor shall any such failure constitute a default hereunder. Landlord acknowledges the Leasehold Mortgagee identified in **Exhibit F** as a holder of a Leasehold Mortgage.

**14.4 Right of Leasehold Mortgagee to Cure.** Notwithstanding any default by Tenant under this Ground Lease, Landlord shall have no right to terminate this Ground Lease unless Landlord shall have given each Leasehold Mortgagee written notice of such default and such Leasehold Mortgagees shall have failed to remedy such default or acquire Tenant's leasehold estate created by this Ground Lease or commence foreclosure or other appropriate proceedings as set forth in, and within the time specified by, this Section 14.4.

A. Any Leasehold Mortgagee which has an outstanding Leasehold Mortgage shall have the right, but not the obligation, at any time to pay any or all of the Rent due pursuant to the terms of this Ground Lease, and do any other act or thing required of Tenant by the terms of this Ground Lease, to prevent termination of this Ground Lease. Each Leasehold Mortgagee shall have 90 days after receipt of notice from Landlord describing such default to cure the default. All payments so made and all things so done shall be as effective to prevent a termination of this Ground Lease as the same would have been if made and performed by Tenant instead of by Leasehold Mortgagees.

B. In addition to the cure period provided in Section 14.4A above, if the default is such that possession of the Premises may be reasonably necessary to remedy the default, any Leasehold Mortgagee shall have a reasonable time after the expiration of such 90 day period within which to remedy such default, provided that (i) such Leasehold Mortgagee shall have fully cured any default in the payment of any monetary obligations of Tenant under this Ground Lease within such 90 day period and shall continue to pay currently such monetary obligations when the same are due and (ii) such Leasehold Mortgagee shall have acquired Tenant's leasehold estate hereunder or commenced foreclosure or other appropriate proceedings prior to or within such period, and shall be diligently prosecuting the same.

C. Any default under this Ground Lease which by its nature cannot be remedied by any Leasehold Mortgagee shall be deemed to be remedied if (i) within 90 days after receiving written notice from Landlord describing the default, or prior thereto, any Leasehold Mortgagee shall have acquired Tenant's leasehold estate or commenced foreclosure or other appropriate proceedings, (ii) Leasehold Mortgagee shall diligently prosecute any such proceedings to completion, (iii) Leasehold Mortgagee shall have fully cured any default in the payment of any monetary obligations of Tenant hereunder which does not require possession of the Premises, and (iv) after gaining possession of the Premises, the Leasehold Mortgagee shall cure all non-monetary defaults of Tenant hereunder capable of cure by Leasehold Mortgagee.

D. If any Leasehold Mortgagee is prohibited, stayed or enjoined by any bankruptcy, insolvency or other judicial proceedings involving Tenant from commencing or prosecuting foreclosure or other appropriate proceedings, the times specified for commencing or prosecuting such foreclosure or other proceedings shall be extended for the period of such prohibition; provided that any Leasehold Mortgagee shall have fully cured any default in the payment of any monetary obligations of Tenant under this Ground Lease and shall continue to pay currently such monetary obligations when the same fall due; provided, further, that such Leasehold Mortgagee shall not interfere with Landlord's efforts to seek compliance by the Tenant with any non-monetary obligation under this Ground Lease.

E. As used in this Section 14.4, "monetary obligations of Tenant" does not include damages, costs and expenses arising from any obligation of Tenant to indemnify Landlord for any acts or omission of Tenant prior to the date a Leasehold Mortgagee assumes the obligations of Tenant hereunder.

**14.5 Limitation on Liability of Leasehold Mortgagee.** No Leasehold Mortgagee shall be or become liable to Landlord as an assignee of this Ground Lease or otherwise unless it expressly assumes by written instrument executed by Landlord and Leasehold Mortgagee such liability (in which event the Leasehold Mortgagee's liability shall be limited to the period of time during which it is the owner of the leasehold estate created hereby) and no assumption shall be inferred from or result from foreclosure or other appropriate proceedings in the nature thereof or as the result of any other action or remedy provided for by such Leasehold Mortgagee or other instrument or from a conveyance from Tenant pursuant to which the purchaser at foreclosure or grantee shall acquire the rights and interest of Tenant under the terms of this Ground Lease.

**14.6 Estoppel Certificates.** Landlord and Tenant agree that at any time and from time to time upon not less than 20 days' prior written notice by the other party, or upon request from any Leasehold Mortgagee or Investor or a permitted assignee, Landlord or Tenant will execute and deliver to the other party or to such Leasehold Mortgagee or Investor a statement in writing certifying (a) that this Ground Lease is unmodified and in full force and effect (or specifying any known amendments if applicable); (b) the date through which the Rents have been paid; and (c) that, to the knowledge of the certifier (if such be the case), there is no default (or any conditions existing which, but for the passage of time or the giving of notice, would constitute a default) set off, defense or other claim against Landlord or Tenant, as applicable, other than those, if any, so specified under the provisions of this Ground Lease. It is intended that any such statement may be relied upon by any persons proposing to acquire the interest of Landlord, Tenant or any Leasehold Mortgagee or Investor, as the case may be, in this Ground Lease or by any prospective Leasehold Mortgagee or Investor or permitted assignee of any Leasehold Mortgagee or Investor.

**14.7 Registration of Leasehold Mortgages.** Upon written request by Landlord, Tenant shall provide written notice to Landlord of the name and address of each Leasehold Mortgagee under this Ground Lease.

**14.8 New Ground Lease.** In the event of the termination of this Ground Lease prior to the natural expiration of the Term of this Ground Lease due to a default of Tenant or operation of law or otherwise (including, without limitation, a rejection or other termination of this Ground Lease pursuant to any bankruptcy filing by or against Tenant or the commencement of any other insolvency proceeding or similar proceeding, an act of condemnation or eminent domain against a portion of the Premises by a government agency or body, the destruction or

damage of the Premises, or upon a foreclosure of Tenant's estate by a Leasehold Mortgagee or acceptance of a deed in lieu of foreclosure or a change in the control or management of Tenant in violation of this Ground Lease), Landlord shall also be obligated to give notice to Leasehold Mortgagee simultaneously under Section 14.3 hereof with such notice given to Tenant; provided that no failure to give such notice to Leasehold Mortgagee shall invalidate the termination of this Ground Lease. Landlord, upon written request from Senior Leasehold Mortgagee and at Senior Mortgagee's sole cost and expense, shall enter into a new lease with such holder or its designee in accordance with and upon the same terms and conditions as set forth in this Ground Lease. In addition, without limiting the preceding sentences, in the event of the filing of a petition in bankruptcy by or against the Tenant, and the Tenant rejects this Ground Lease under the then applicable provisions of the Bankruptcy Code, Landlord shall, upon the request of a Leasehold Mortgagee and at Senior Leasehold Mortgagee or its designee's sole cost and expense, affirm this Ground Lease, and Landlord will enter into a new ground lease on the same terms and conditions set forth in this Ground Lease with such holder or its designee promptly upon Tenant's rejection of this Ground Lease. In the event of the filing of a petition in bankruptcy by the Landlord, and the Landlord rejects this Ground Lease and the Tenant does not affirm it, a Leasehold Mortgagee will have the authority to affirm this Ground Lease on behalf of the Tenant and to keep the Ground Lease in full force and effect.

A. After cancellation and termination of this Ground Lease, and upon compliance with the provisions of this Section 14.8 by Leasehold Mortgagee, or its designee, upon the request of Leasehold Mortgagee or its designee within the time provided in Section 14.4 hereof, Landlord shall, at Senior Leasehold Mortgagee or its designee's sole cost and expense, execute and deliver such new ground lease to such Leasehold Mortgagee or its designee, having the same relative priority in time and right as this Ground Lease (to the extent possible) and having the benefit of all the right, title, interest, powers and privileges, and obligations and liabilities of Tenant hereunder in and to the Premises.

**14.9 Rights of Investor.** The Investor shall have the same notice and cure rights as any Leasehold Mortgagee (including monetary obligations) as set forth in Section 14.4 for so long as it is a limited partner of Tenant; provided, however, that Investor shall be deemed to have met any condition relating to commencement or continuation of a foreclosure proceeding as set forth in Section 14.4 above, if it is attempting with diligence and in good faith to remove the general partner of Tenant. The address for any notices to Investor, as of the date hereof, is provided in Basic Lease Information Section 14.

**14.10 Transfers.** The consent of Landlord shall not be required for the mortgage of Tenant's interest in the Premises and Premises Improvements to any Leasehold Mortgagee, including, without limitation, Senior Leasehold Mortgagee, and transfer of the Premises and Premises Improvements to such Leasehold Mortgagee by foreclosure or deed-in-lieu of foreclosure (or the leasehold equivalent thereof), or to a third-party purchaser pursuant to a foreclosure sale (or the leasehold equivalent thereof); the consent of Landlord to a Transfer by a Leasehold Mortgagee after acquisition by foreclosure, at Senior Leasehold Mortgagee or its designee's sole cost and expense, will not be unreasonably withheld or delayed.

**14.11 Permitted Use Requirements.** Following a transfer of the Premises to any Leasehold Mortgagee (or its nominee or assignee), including, without limitation, Senior Leasehold Mortgagee, and transfer of the Premises and Premises Improvements to such Leasehold Mortgagee by foreclosure or deed-in-lieu of foreclosure (or the leasehold equivalent thereof), or to a third-party purchaser pursuant to a foreclosure sale (or the leasehold equivalent

thereof), notwithstanding anything to the contrary in this Ground Lease, the Permitted Use of the Premises shall be as specified by the zoning or applicable City conditions of approval.

**14.12 Further Ground Lease Amendments.** Landlord shall cooperate in including in this Ground Lease by suitable amendment from time to time any provision which may reasonably be requested by any Leasehold Mortgagee or any proposed lender, at Leasehold Mortgagee or proposed lender's sole cost and expense, for the purpose of implementing the mortgagee-protection provisions contained in this Ground Lease and allowing such Leasehold Mortgagee or proposed lender reasonable means to protect or preserve the lien of the leasehold mortgage and the value of its security, and to include any additional rights and privileges reasonably requested to be added by such Leasehold Mortgagee. Landlord agrees to execute and deliver (and to acknowledge, if necessary, for recording purposes) any agreement necessary to effect any such amendment; provided, however, that any such amendment shall not in any way affect Landlord's fee estate in the Site or any other interest of Landlord in the Site or Premises, affect the Term or rent under this Ground Lease, or otherwise in any material respect adversely affect any rights of Landlord under this Ground Lease or (except as otherwise expressly provided herein) Regulatory Requirements.

## ARTICLE 15. MISCELLANEOUS

**15.1 Holding Over.** If Tenant shall hold over in the Premises Improvements or Premises after the expiration or termination of the Term hereof with or without the consent of Landlord, such holding over shall be construed to be only a tenancy from month to month, subject to all the covenants, conditions and obligations contained in this Ground Lease. Tenant hereby agrees to pay to Landlord as monthly rental \$500 per month, plus all Additional Rent as otherwise required in this Ground Lease.

**15.2 Attorneys' Fees.** In the event that any action is brought by either party hereto against the other for the enforcement or declaration of any right or remedy in or under this Ground Lease or for the breach of any covenant or condition of this Ground Lease, the prevailing party shall be entitled to recover, and the other party agrees to pay, all fees and costs to be fixed by the court therein including, but not limited to, attorneys' fees.

**15.3 Quiet Possession.** Landlord agrees that so long as Tenant is not in default under this Ground Lease and is paying the Rent and performing all of the covenants and conditions of this Ground Lease, Tenant shall quietly have, hold and enjoy the Premises throughout the Term hereof without interruption or disturbance from Landlord or any other persons claiming by, through or under Landlord. For purposes of this Section 15.3, persons exercising their rights under the Site REA or Hope Center REA shall be deemed to a person claiming by, through or under Tenant.

**15.4 Force Majeure.** Except as to the payment of Rent, subject to the limitations set forth below, performance by either party hereunder (including without limitation continuing obligations under the DDA) shall not be deemed to be in default, and all performance and other dates specified in this Ground Lease shall be extended, where delays are due to: war; insurrection; strikes; lockouts; riots; floods; earthquakes; fires; casualties; acts of God; acts of the public enemy; epidemics; quarantine restrictions; freight embargoes; governmental restrictions or priority; unusually severe weather; lack of reasonable availability of labor or materials; acts or omissions of the other party; or acts or failures to act of the City or any other public or governmental agency or entity (other than the acts or failures to act of Landlord which

shall not excuse performance by Landlord) (together, “**Force Majeure**”). An extension of time for any such cause shall be for the period of the enforced delay and shall commence to run from the time of the commencement of the cause, if notice by the party claiming such extension is sent to the other party with reasonable promptness (not more than 30 days) of the commencement of the cause. Times of performance under this Ground Lease may also be extended in writing by the mutual agreement of Landlord and Tenant. Tenant expressly agrees that post-Ground Lease Date adverse changes in economic conditions, either of Tenant specifically or the economy generally, changes in market conditions or demand, and/or Tenant’s inability to obtain financing or other lack of funding, shall not constitute a Force Majeure delay pursuant to this Section 15.4. Tenant expressly assumes the risk of such adverse economic or market changes and/or financial inability, whether or not foreseeable as of the Ground Lease Date.

**15.5 Notices.** Any notice to be given or other document to be delivered by either party to the other hereunder shall be in writing and shall be deemed to have been duly given and received (i) upon personal delivery, (ii) as of the third business day after mailing by United States registered or certified mail, return receipt requested, postage prepaid, addressed as set forth below, or (iii) the immediately succeeding business day after deposit with Federal Express or other equivalent overnight delivery system, addressed to the party for whom intended, as indicated in the Basic Ground Lease Information. Any party hereto may from time to time, by written notice to the other, designate a different address which shall be substituted for the one above specified.

**15.6 Waiver.** No waiver of any breach of any of the terms, covenants, agreements, restrictions or conditions of this Ground Lease shall be construed to be a waiver of any succeeding breach of the same or other terms, covenants, agreements, restrictions and conditions hereof.

**15.7 Surrender.** Upon the expiration or sooner termination of the Term of this Ground Lease, and notwithstanding anything herein contained to the contrary, Tenant shall surrender to Landlord the Premises Improvements, the Premises and any other improvements thereon, broom clean and in good condition and repair, reasonable wear and tear excepted.

**15.8 Binding.** Subject to the restrictions set forth herein regarding assignment of , Tenant’s interest in this Ground Lease, each of the terms, covenants and conditions of this Ground Lease shall extend to and be binding on and shall inure to the benefit of not only Landlord and Tenant, but to each of their respective heirs, administrators, executors, successors and assigns. Whenever in this Ground Lease reference is made to either Landlord or Tenant, the reference shall be deemed to include, wherever applicable, the heirs, administrators, executors, successors and assigns of such parties, the same as if in every case expressed.

**15.9 Disclaimer of Partnership.** The relationship of the parties hereto is that of Landlord and Tenant, and it is expressly understood and agreed that Landlord does not in any way nor for any purpose become a partner of Tenant or a joint venturer with Tenant in the Premises Improvements or in the conduct of Tenant’s business or operations or otherwise.

**15.10 Quitclaim.** At termination or expiration of the Term of this Ground Lease, Tenant shall execute, acknowledge and deliver to Landlord within 30 days, a valid and recordable quitclaim deed covering the Premises and Premises Improvements, free and clear of all monetary liens and encumbrances not caused or agreed to by Landlord (“**Quitclaim**”).

**Deed**”). If Tenant fails to clear all monetary liens and encumbrances as required by this Section at termination or expiration of the Term of this Ground Lease, Tenant shall continue to be liable and responsible for all such costs, liabilities and expenses associated with, related to or caused by such encumbrances that were not removed by Tenant, and Landlord may take any and all action to enforce its rights under this Ground Lease and to have such encumbrances removed, and all costs and expenses associated with such actions shall be paid solely by Tenant upon Landlord’s demand

**15.11 Interpretation.** The titles to the sections of this Ground Lease are not a part of this Ground Lease and shall have no effect upon the construction or interpretation of any part of this Ground Lease. As used in this Agreement, masculine, feminine or neuter gender and the singular or plural number shall each be deemed to include the others where and when the context so dictates. The word “including” shall be construed as if followed by the words “without limitation.” This Ground Lease shall be interpreted as though prepared jointly by both parties.

**15.12 Severability.** If any term, provision, condition or covenant of this Ground Lease or its application to any party or circumstances shall be held, to any extent, invalid or unenforceable, the remainder of this Ground Lease, or the application of the term, provision, condition or covenant to persons or circumstances other than those as to whom or which it is held invalid or unenforceable, shall not be affected, and shall be valid and enforceable to the fullest extent permitted by Law.

**15.13 Computation of Time.** The time in which any act is to be done under this Ground Lease is computed by excluding the first day, and including the last day, unless the last day is a holiday or Saturday or Sunday, and then that day is also excluded. The term “holiday” shall mean all holidays as specified in Sections 6700 and 6701 of the California Government Code. If any act is to be done by a particular time during a day, that time shall be Pacific Time Zone time.

**15.14 Legal Advice.** Each party represents and warrants to the other the following: they have carefully read this Ground Lease, and in signing this Ground Lease, they do so with full knowledge of any right which they may have; they have received independent legal advice from their respective legal counsel as to the matters set forth in this Ground Lease, or have knowingly chosen not to consult legal counsel as to the matters set forth in this Ground Lease; and, they have freely signed this Ground Lease without any reliance upon any agreement, promise, statement or representation by or on behalf of the other party, or their respective agents, employees, or attorneys, except as specifically set forth in this Ground Lease, and without duress or coercion, whether economic or otherwise.

**15.15 Time of Essence.** Time is expressly made of the essence with respect to the performance by Landlord and Tenant of each and every obligation and condition of this Ground Lease.

**15.16 Nonliability of Officials, Employees, etc.** No member, official or employee of Landlord shall be personally liable to Tenant, or any successor in interest, in the event of any default or breach by Landlord or for any amount which may become due to Tenant or its successors, or on any obligations under the terms of this Ground Lease. Tenant hereby waives and releases any claim it may have against the members, officials or employees of Landlord with respect to any default or breach by Landlord or for any amount which may become due to Tenant or its successors, or on any obligations under the terms of this Ground

Lease. No member, partner (other than general partners as otherwise permitted by law), or board member, officer or employee of Tenant (or of any of Tenant's members or partners) shall be personally liable to Landlord, or any successor in interest, in the event of any default or breach by Tenant or for any amount which may become due to Landlord or its successors, or on any obligations under the terms of this Ground Lease. Landlord hereby waives and releases any claim it may have against Tenant's members, partners (other than general partners as otherwise permitted by law), or board members, officers or employees (or of any of Tenant's members or partners) with respect to any default or breach by Tenant or for any amount which may become due to Landlord or its successors, or on any obligations under the terms of this Ground Lease.

**15.17 Assignment by Landlord.** Landlord may assign or transfer any of its interests hereunder at any time without Tenant's consent. Any such assignment or transfer shall be in compliance with all Laws, and the assignee or transferee shall affirmatively assume all Landlord obligations hereunder.

**15.18 Applicable Law.** The laws of the State of California, including all statutes of limitations but without regard to conflict of laws principles, shall govern the interpretation and enforcement of this Ground Lease.

**15.19 Covenants and Conditions.** Each obligation of the parties hereunder, including, without limitation, Tenant's obligation for the payment of Rent, shall be construed to be both a covenant and a condition of this Ground Lease.

**15.20 Integration.** This Ground Lease, together with all exhibits and attachments hereto, the Site REA, Hope Center REA, and Regulatory Requirements (collectively, "**Improvements Documents**"), excluding the City Financing Documents, constitute the entire agreement between the parties relating to the Premises and there are no conditions, representations or agreements regarding the matters covered by this Ground Lease which are not expressed herein or in the Improvements Documents. Without limiting the foregoing, except as expressly provided in this Ground Lease (including without limitation **Exhibit C**), this Ground Lease supersedes the DDA. Notwithstanding the foregoing, nothing herein will limit or restrict the rights of any party under the Improvements Documents and City Financing Documents.

**15.21 Amendments to this Ground Lease.** Landlord and Tenant agree to mutually consider reasonable requests for amendments to this Ground Lease that may be made by either of them, lending institutions or bond counsel or financial consultants to Landlord or Tenant, provided such requests are consistent with this Ground Lease and would not materially alter the basic business terms herein or the other Improvements Documents. No amendment shall be effective unless in writing and signed by the parties hereto.

**15.22 Proprietary and Governmental Roles: Actions by City.** Except where clearly and expressly provided otherwise in this Ground Lease, the capacity of the City in this Ground Lease shall be as owner and lessor of property only ("**Proprietary Capacity**"), and any obligations or restrictions imposed by this Ground Lease on the City shall be limited to that capacity and shall not relate to, constitute a waiver of, supersede or otherwise limit or affect its governmental capacities, including enacting laws, inspecting structures, reviewing and issuing permits, and all of the other legislative and administrative or enforcement functions pursuant to federal, state or local law ("**Governmental Capacity**"). When acting in its Proprietary Capacity, discretionary actions may be undertaken by the City Manager or other designees as designated



by the City Manager to the extent otherwise provided herein. In addition, nothing in this Ground Lease shall supersede or waive any discretionary or regulatory approvals required to be obtained from the City under applicable Law.

**15.23 City Manager Authority and Limitations.** Any amendment to this Ground Lease which affects or relates to: (i) the Term of this Ground Lease; (ii) the permitted use of the Premises and Premises Improvements; (iii) Rent amounts and other monetary payments by Tenant; or (iii) any other material provision of this Ground Lease, shall require approval by the Landlord's City Council. Subject to the foregoing, the City Manager may also issue without City Council approval any consent or approval which Landlord is entitled to provide under this Ground Lease, including without limitation: (w) Material Alterations under Section 5.6 above; (x) assignments under Section 12.1; (y) sublettings under Section 12.2; and (z) rules for a CASp inspection under Section 15.29.

**15.24 Brokerage Commissions.** Landlord and Tenant each represents that it has not been represented by any broker in connection with this Ground Lease, and that no real estate broker's commission, finder's fee or other compensation (individually and collectively, "**Brokerage Commission**") is due or payable. Landlord and Tenant each agrees to indemnify and hold the other harmless from any claims or liability, including reasonable attorneys' fees, in connection with a claim by any person for a Brokerage Commission based upon any statement, representation or agreement of the other party.

**15.25 City Non-Discrimination Ordinance.** Tenant hereby agrees to comply with the provisions of the Berkeley Municipal Code ("**B.M.C.**"), including without limitation Chapter 13.26, as amended from time to time. In the performance of its obligations under this Ground Lease, Tenant agrees as follows:

A. Tenant shall not discriminate against any employee or applicant for employment because of race, color, religion, ancestry, national origin, age (over 40), sex, pregnancy, marital status, disability, sexual orientation or AIDS.

B. Tenant shall permit Landlord access to records of employment, employment advertisements, application forms, EEO-1 forms, affirmative action plans and any other documents which, in the reasonable opinion of Landlord, are necessary to monitor compliance with this non-discrimination provision. In addition, Tenant shall fill out, in a timely fashion, forms supplied by Landlord to monitor this non-discrimination provision.

**15.26 Non-Discrimination Against Persons With Disabilities.**

A. If Tenant provides any aid, service or benefit to others on the Landlord's behalf, Tenant shall, in the provision of such aid, service or benefit, observe and comply with all applicable provisions of Title II of the Americans with Disabilities Act of 1990 and any amendments thereto. Tenant shall further observe and comply with all applicable federal, state, municipal and local laws, ordinances, codes and regulations prohibiting discrimination against individuals with disabilities or ensuring that individuals with disabilities are not excluded from participating in or receiving benefits, services or activities of the Landlord, if applicable.

B. If Tenant is or becomes a "public accommodation" as defined in Title III of the Americans with Disabilities Act of 1990, Tenant shall observe and comply with all applicable provisions of the Act and any amendments thereto, and all applicable federal, state, municipal and local laws, ordinances, codes and regulations prohibiting discrimination on the basis of

disability in the full and equal enjoyment of goods, services, facilities, privileges, advantages, or accommodations offered by the Tenant. All of Tenant's activities must be in accordance with these laws, ordinances, codes, and regulations, and Tenant shall be solely responsible for complying therewith.

**15.27 Conflict of Interest Prohibited.**

A. In accordance with California Government Code Section 1090, Berkeley City Charter Section 36 and B.M.C. Chapter 3.64, neither Tenant nor any employee, officer, director, partner or member of Tenant, or immediate family member of any of the preceding, shall have served as an elected officer, an employee, or a committee or commission member of Landlord, who has directly or indirectly influenced the making of this Ground Lease.

B. In accordance with California Government Code Section 1090 and the Political Reform Act, (Government Code Section 87100 et seq.) no person who is a director, officer, partner, trustee, employee or consultant of Tenant, or immediate family member of any of the preceding, shall make or participate in a decision made by Landlord or any of its boards, commissions or committees, if it is reasonable foreseeable that the decision will have a material effect on any source of income, investment or interest in real property of that person or Tenant, except to the extent permitted by 2 California Code of Regulations, Section 18700(c)(2).

C. Interpretation of this paragraph shall be governed by the definitions and provisions use in the Political Reform Act, Government Code section 87100 et seq., its implementing regulations, manuals and codes, Government Code section 1090, Berkeley City Charter section 36 and B.M.C. Chapter 3.64, as amended from time to time.

**15.28 Nuclear Free Berkeley.** Tenant agrees to comply with B.M.C. Chapter 12.90, the Nuclear Free Berkeley Act, as amended from time to time.

**15.29 Required Accessibility Disclosure.**

A. Landlord hereby advises Tenant that the Premises and Premises Improvements have not undergone an inspection by a certified access specialist, and except to the extent expressly set forth in this Ground Lease, Landlord shall have no liability or responsibility to make any repairs or modifications to the Premises or the Premises Improvements in order to comply with accessibility standards. The following disclosure is hereby made pursuant to applicable California law:

B. "A Certified Access Specialist (CASp) can inspect the subject premises and determine whether the subject premises comply with all of the applicable construction-related accessibility standards under state law. Although state law does not require a CASp inspection of the subject premises, the commercial property owner or lessor may not prohibit the lessee or tenant from obtaining a CASp inspection of the subject premises for the occupancy or potential occupancy of the lessee or tenant, if requested by the lessee or tenant. The parties shall mutually agree on the arrangements for the time and manner of the CASp inspection, the payment of the fee for the CASp inspection, and the cost of making any repairs necessary to correct violations of construction-related accessibility standards within the premises." [Cal. Civ. Code Section 1938(e)]. Any CASp inspection shall be conducted in compliance with reasonable rules in effect at the Premises with regard to such inspections and shall be subject to Landlord's prior written consent.

**15.30 Oppressive States.**

A. In accordance with Resolution No. 59,853-N.S., Tenant certifies that it has no contractual relations with, and agrees during the Term of this Ground Lease to forego contractual relations to provide personal services to, the following entities:

1. The governing regime in any Oppressive State.
2. Any business or corporation organized under the authority of the governing regime of any Oppressive State.
3. Any individual, firm, partnership, corporation, association, or any other commercial organization, and including parent-entities and wholly-owned subsidiaries (to the extent that their operations are related to the purpose of this Ground Lease) for the express purpose of assisting in business operations or trading with any public or private entity located in any Oppressive State.

B. For purposes of this Ground Lease, the Tibet Autonomous Region and the provinces of Adu, Kham, and U-Tsang shall be deemed oppressive states.

C. Tenant's failure to comply with this Section shall constitute a default of this Ground Lease and Landlord may terminate this Ground Lease pursuant to ARTICLE 13. In the event that Landlord terminates this Ground Lease due to a default under this provision, Landlord may deem Tenant a non-responsible bidder for five years from the date this Ground Lease is terminated.

**15.31 Berkeley Living Wage Ordinance (LWO).**

A. Tenant agrees to comply with Berkeley Municipal Code Chapter 13.27, the Berkeley Living Wage Ordinance. If Tenant employs six or more part-time or full-time employees, and generates \$350,000 or more in annual gross receipts, Tenant will be required to provide all eligible employees with City mandated minimum compensation during the Term of this Ground Lease, as defined in B.M.C. Chapter 13.27, and well as comply with the terms enumerated herein.

B. Tenant shall be required to maintain all reasonable records and documents that would establish whether Tenant is subject to Berkeley's Living Wage Ordinance ("LWO"). If Tenant is subject to the LWO, as defined therein, Tenant shall be further required to maintain monthly records of those employees located on the leased Premises. These records shall include the total number of hours worked, the number of hours spent providing service on the leased Premises, the hourly rate paid, and the amount paid by Tenant for health benefits, if any, for each of its employees providing services under the lease. The records described in this Section shall be made available upon the Landlord's request. The failure to produce these records upon demand shall be considered a default, subject to the provisions contained in ARTICLE 13 herein.

C. If Tenant is subject to the LWO, Tenant shall include the requirements of the ordinance, as defined in B.M.C. Chapter 13.27, in any and all subleases in which Tenant enters with regard to the subject Premises. Subtenants shall be required to comply with this ordinance with regard to any employees who spend 25% or more of their compensated time on the leased Premises.

D. If Tenant fails to comply with the requirements of the LWO and this Ground Lease, the Landlord shall have the rights and remedies described in this Section, in addition to any rights and remedies provided by law or equity.

E. Tenant's failure to comply with this Section shall constitute a default of the Ground Lease, upon which City may terminate this Ground Lease pursuant to ARTICLE 13.

F. In addition, at City's sole discretion, Tenant may be responsible for liquidated damages in the amount of \$50 per employee per day for each and every instance of an underpayment to an employee. It is mutually understood and agreed that Tenant's failure to pay any of its eligible employees at least the applicable living wage rate will result in damages being sustained by the City; that the nature and amount of the damages will be extremely difficult and impractical to fix; that the liquidated damages set forth herein is the nearest and most exact measure of damage for such breach that can be fixed at this time; and that the liquidated damage amount is not intended as a penalty of forfeiture for Tenant's breach.

**15.32 Berkeley Equal Benefits Ordinance (EBO).**

A. Tenant hereby agrees to comply with the provisions of the Berkeley Equal Benefits Ordinance, B.M.C. Chapter 13.29. If Tenant is currently or becomes subject to the Berkeley Equal Benefits Ordinance, Tenant will be required to provide all eligible employees with City mandated equal benefits during the Term of this Ground Lease, as defined in B.M.C. Chapter 13.29, as well as comply with the terms enumerated herein.

B. If Tenant is currently or becomes subject to the Berkeley Equal Benefits Ordinance, Tenant agrees to supply the City with any records the City deems necessary to determine compliance with this provision. Failure to do so shall be a considered a default, subject to the provisions of ARTICLE 13.

C. If Tenant fails to comply with the requirements of this Section, City shall have the rights and remedies described in this Section, in addition to any rights and remedies provided by law or equity. Tenant's failure to comply with this Section shall constitute default of the Ground Lease, upon which City may terminate this Ground Lease pursuant to ARTICLE 13.

D. In addition, at City's sole discretion, Tenant may be responsible for liquidated damages in the amount of \$50.00 per employee per day for each and every instance of violation of this Section. It is mutually understood and agreed that Tenant's failure to provide its employees with equal benefits will result in damages being sustained by City; that the nature and amount of these damages will be extremely difficult and impractical to fix; that the liquidated damages set forth herein is the nearest and most exact measure of damages for such breach that can be fixed at this time; and that the liquidated damage amount is not intended as a penalty or forfeiture for Tenant's breach.

**15.33 Audit.** In addition to any other Landlord audit right herein, the City Auditor's Office, or its designee, may conduct an audit of Tenant's financial and compliance records maintained in connection with the operations and services performed under this Ground Lease, and with the payments made under this Ground Lease. In the event of such audit, Tenant agrees to make all such financial and compliance records available to the Auditor's Office, or to its designee. City agrees to provide Tenant an opportunity to discuss and respond to any findings before a final audit report is filed.

**15.34 City Business License, Payment of Taxes, Tax I.D. Number.** Tenant has obtained a City business license as required by B.M.C. Chapter 9.04, and its license number is written below; or, Tenant is exempt from the provisions of B.M.C. Chapter 9.04 and has written below the specific B.M.C. section under which it is exempt. Tenant shall pay all state and federal income taxes and any other taxes due. Tenant certifies under penalty of perjury that the taxpayer identification number written below is correct.

**15.35 Survival.** The provisions of Sections 4.1 (Impositions), 5.6 (Alterations), 5.9 (Liens and Stop Notices), 6.2 (Governmental Requirements), 6.7 (General Standards of Maintenance), 7.2 (Hazardous Materials), 9.2 (Indemnity), 15.7 (Surrender) and any other obligation of Tenant that, by its terms or nature, is to be performed after or is to survive expiration or termination of this Ground Lease, shall survive such expiration or termination.

IN WITNESS WHEREOF, Landlord and Tenant have caused this Ground Lease to be executed on their behalf by their respective officers thereunto duly authorized as of the dates set forth below.

*[Signature Page Follows]*

**TENANT:**

BFHP Hope Center LP, a California limited partnership

By: \_\_\_\_\_

Print Name: \_\_\_\_\_

Its: \_\_\_\_\_

By: \_\_\_\_\_

Print Name: \_\_\_\_\_

Its: \_\_\_\_\_

Date: \_\_\_\_\_

**LANDLORD:**

CITY OF BERKELEY, a Charter city

By: \_\_\_\_\_

Dee Williams-Ridley  
City Manager

Date: \_\_\_\_\_

**Approved as to form:**

\_\_\_\_\_  
Farimah Brown, City Attorney

**Registered by:**

\_\_\_\_\_  
\_\_\_\_\_, City Auditor

**Attest:**

\_\_\_\_\_  
\_\_\_\_\_, City Clerk

**TENANT INFORMATION**

Tax Identification No. \_\_\_\_\_

Incorporated: Yes \_\_\_\_ No \_\_\_\_

Certified Woman Business Enterprise: Yes \_\_\_\_ No \_\_\_\_

Certified Minority Business Enterprise: Yes \_\_\_\_ No \_\_\_\_

Certified Disadvantaged Business Enterprise: Yes \_\_\_\_ No \_\_\_\_

City Business License No. \_\_\_\_\_, or  
Exempt pursuant to B.M.C. Section \_\_\_\_

**EXHIBIT A**

**PREMISES LEGAL DESCRIPTION**

The land referred to is situated in the City of Berkeley, County of Alameda, State of California, and is described as follows:

PARCEL ONE:

Parcel B , as shown on the Parcel Map 11051, filed \_\_\_\_\_, 2020 in Book \_\_\_ of Parcel Maps, Pages \_\_\_ and \_\_\_, Alameda County Records, EXCEPTING THEREFROM all buildings and improvements situated thereon, which buildings and improvements are and shall remain real property.

PARCEL TWO:

Easements for construction, maintenance, utilities, structural support and encroachment, set forth in that certain Declaration of and Agreement Regarding Covenants, Conditions and Restrictions Providing for Reciprocal Easements, Joint Use and Maintenance for Berkeley Way, dated \_\_\_\_\_, 2020, executed by the City of Berkeley and BRIDGE Berkeley Way LP and BFHP Hope Center LP, and recorded in Alameda County Records on \_\_\_\_\_, 2020, as Instrument No. \_\_\_\_\_; and Easements for access, use, ingress and egress, set forth in that certain Declaration of and Agreement Regarding Covenants, Conditions and Restrictions Providing for Reciprocal Easements, Joint Use and Maintenance for the BFHP Hope Center, dated \_\_\_\_\_, 2020, executed by the City of Berkeley and BFHP Hope Center LP, and recorded in Alameda County Records on \_\_\_\_\_, 20\_\_\_\_, as Instrument No. \_\_\_\_\_, 2020.

Being a portion of APN 057-2053-022-01

EXHIBIT B

DEVELOPMENT SITE PARCEL MAP

*[Draft to be attached—final to be included before signing]*



**EXHIBIT C**

**CERTAIN DDA PROVISIONS**

1. The following DDA provisions have been fully satisfied or waived:
  - a. Section 2.1 (Conditions Precedent to Lease of Property).
  - b. Section 2.2 (Developer Deposit).
  - c. Section 2.3 (Development Schedule).
  - d. Section 2.4 (Development Services Agreement).
  - e. Section 2.5 (Creation of and Assignments to Permitted Lessees).
  - f. Section 2.6 (Developer Approval of Property).
  - g. Section 2.7 (Developer Approval of Title Matters).
  - h. Section 2.8 (Agreement on Leases).
  - i. Section 2.9 (Agreement on Reciprocal Easement Agreement).
  - j. Section 2.10 (Agreement on Completion Guaranty Agreement).
  - k. Section 2.11 (City and Other Governmental Approvals).
  - l. Section 2.12 (Financing Proposals and Financing Plans for the Development).
  - m. Section 2.13 (Evidence of Availability of Funds).
  - n. Section 2.14 (Construction Contract(s)).
  - o. Section 2.15 (Construction Bonds).
  - p. Section 2.16 (Building Permits).
  - q. Section 2.17 (Construction Drawings).
  - r. Section 2.18 (Final Subdivision Map).
  - s. Section 2.19 (No Default).
  - t. Section 2.20 (Permits and Approvals Final; Absence of Litigation).
  - u. Section 2.21 (Insurance).
  - v. Section 2.22 (Representations and Warranties; No Material Adverse Change).

- w. Article III (Design Requirements), except for Sections 3.7 and 3.8.
  - x. Article IV (Lease Disposition of Property) except for Sections 4.5 (see below), 4.6 (with respect to post-closing ad valorem taxes (if any) and other potential pre-closing and post-closing costs) and 4.7.
2. The following DDA provisions are terminated:
- a. Section 3.7 (No Change in Project Documents).
  - b. Section 3.8 (Additional Permits and Approvals).
  - c. Article VII (Assignment and Transfers).
  - d. Article VIII (Termination, Default and Remedies). (Remedies for default in any continuing obligation under the DDA shall be as provided in the Ground Lease.)
  - e. Section 9.3 (Enforced Delay).
  - f. Section 9.19 (Right of Entry to Perform Studies).
3. The following DDA provisions, attached hereto, remain in full force and effect, except to the extent provided below:
- a. Section 4.5 (Condition of Property) remains in full force and effect.
  - b. Section 4.6 (Costs of Escrow and Closing).
  - c. Section 4.7 (Obligations After Lease).
  - d. Article V (Construction of the Development) remains in full force and effect, and is incorporated into Section 5.1 of the Leases and the JDA.
  - e. Article VI (Ongoing Developer Obligations) (except to the extent modified in the Ground Lease or as attached hereto).
  - f. Section 9.1 (Notices, Demands and Communications), but only to the extent notices are required under the DDA, and not some other agreement with its own notice provisions.
  - g. Section 9.2 (Non-Liability of City Officials, Employees and Agents), Section 9.4 (Inspection of Books and Records), Section 9.5 (Provision Not Merged with Leases) and Section 9.6 (Title of Parts and Sections) shall remain in full force and effect.
  - h. Section 9.7 (Indemnification) shall remain in full force and effect against Developer except to the extent assumed by BRIDGE LP and BFHP LP, and otherwise in full force and effect against BRIDGE LP and BFHP LP.
  - i. Section 9.8 (Applicable Law), Section 9.9 (No Brokers), Section 9.10 (Severability), Section 9.11 (Binding Upon Successors), Section 9.12 (Parties Not Co-Venturers), Section 9.13 (Time of the Essence), Section 9.14 (Action by the City), Section 9.15 (Discretion Retained by City), Section 9.16 (Representations and Warranties by Developer), and

Section 9.17 (Multiple Originals; Complete Understanding of the Parties), remain in full force and effect.

j. Except as provided in Leases Subsection 1.1A, Section 9.18 (Conflict Among City Documents) remains in full force and effect to the extent any applicable DDA provision remains in effect.

EXHIBIT D

SITE RECIPROCAL EASEMENT AGREEMENT (REA 1)

*[to be provided]*



EXHIBIT D1

HOPE CENTER RECIPROCAL EASEMENT AGREEMENT (REA 2)

*[to be provided]*



EXHIBIT E

RESOLUTION NO. AAAA-N.S.

*[to be attached]*





EXHIBIT F

INITIAL LEASEHOLD MORTGAGES AND MORTGAGEES

**[to be provided—identify “Senior Leasehold Mortgagee” if any and include notice addresses]**

EXHIBIT G

CITY FINANCING DOCUMENTS

*[to be provided]*





12-19-2019

**DECLARATION OF AND AGREEMENT REGARDING COVENANTS, CONDITIONS  
AND RESTRICTIONS PROVIDING FOR RECIPROCAL EASEMENTS, JOINT USE  
AND MAINTENANCE FOR BERKELEY WAY**

THIS DECLARATION OF AND AGREEMENT REGARDING COVENANTS, CONDITIONS AND RESTRICTIONS PROVIDING FOR RECIPROCAL EASEMENTS, JOINT USE AND MAINTENANCE FOR BERKELEY WAY (the "Declaration") is made as of \_\_\_\_\_, 2020 (the "Effective Date"), by the City of Berkeley (the "City") as owner of the fee interest in the Property described herein, and BRIDGE Berkeley Way LP and BFHP Hope Center LP, as lessees of portions of said Property (City and said lessees being referred to herein collectively as the "Berkeley Way Declarants"), with reference to the following facts:

RECITALS

- A. These Recitals refer to and utilize certain capitalized terms that are defined in Article 1 of this Declaration.
- B. The City owns certain real property located at 2012 Berkeley Way in Berkeley, California, as more particularly described in Exhibit A attached hereto and incorporated herein (the "Property"). Berkeley Way Declarants have caused the subdivision of the Property pursuant to the Map. The Map and this Declaration collectively delineate the BRIDGE Affordable Development and the BFHP Hope Center Development, which includes the BFHP Hope Center Permanent Supportive Housing and the BFHP Hope Center Temporary Housing. The BRIDGE Affordable Development is located on the BRIDGE Affordable Parcel and the BFHP Hope Center Development is located on the BFHP Hope Center Parcels.
- C. City has no current intention of developing the BRIDGE Affordable Development, BFHP Hope Center Development or the Parcels comprising the Property. Concurrently with the making of this Declaration, the City has leased the BRIDGE Affordable Parcel to the BRIDGE Affordable Partnership for the purpose of developing and operating the BRIDGE Affordable Development and has leased the BFHP Hope Center Parcels to the BFHP Hope Center Partnership for the purpose of developing the BFHP Hope Center. BFHP Hope Center Partnership is intended to be the long term operator of the Permanent Supportive Housing Development portion of the BFHP Hope Center and BFHP Hope Center LLC is intended to be the long term lessee and operator of the Temporary Housing Development portion of the BFHP Hope Center.
- D. Pursuant to this Declaration, the Berkeley Way Declarants are (i) setting forth certain rights and responsibilities pertaining to the easements affecting the Property granted herein and by virtue of the Map, and (ii) providing for the management, maintenance and operation of the Parcels, and certain joint uses thereof.
- E. The Project is not a common interest development as defined by Civil Code Section 4100. The Project and the Lessees are therefore not subject to the

12-19-2019

Davis-Stirling Common Interest Development Act (codified at Civil Code Sections 4000 et seq.).

F. Concurrently with the recordation of this Declaration, the City and BFHP Hope Center LP will record that certain Declaration of and Agreement Regarding Covenants, Conditions and Reciprocal Easements, Joint Use and Maintenance for the BFHP Hope Center dated and recorded of even date herewith as it may be amended, the "REA 2").

WITH REFERENCE TO THE FACTS RECITED ABOVE, the Berkeley Way Declarants declare and agree as follows:

ARTICLE 1  
DEFINITIONS

1.1 Definitions. In addition to the terms defined elsewhere in this Declaration, the following definitions shall apply:

(a) "Berkeley Way Annual Joint Expenses Budget" has the meaning given in Section 5.3.

(b) "Berkeley Way Assessments" means Berkeley Way Joint Expenses Assessments, Berkeley Way Reimbursement Assessments and/or Berkeley Way Special Joint Expenses Assessments.

(c) "Berkeley Way Creditor Lessee" means a Lessee to whom an Berkeley Way Assessment is owed by another Lessee or a Lessee seeking to ensure payments required under Section 5.8 are made to a reserve account.

(d) "Berkeley Way Debtor Lessee" means a Lessee who owes either an Berkeley Way Assessment to another Lessee or a payment required under Section 5.8 to be made to its reserve account which Berkeley Way Assessment or payment has not been made when due.

(e) "Berkeley Way Declarants" has the meaning set forth in the preamble of this Declaration.

(f) "Berkeley Way Joint Expenses" means, collectively, (i) all expenses and costs of the Berkeley Way Joint Policy, (ii) all costs and expenses of Maintenance of Berkeley Way Project-Serving Components, and (iii) any other expenses provided for in an Annual Berkeley Way Joint Expense Budget or that this Declaration provides to be paid by a Lessee according to its Designated Share.

(g) "Berkeley Way Joint Expenses Assessment" has the meaning given in Section 5.4.

(h) "Berkeley Way Joint Maintenance Committee" means the committee responsible for the coordination of the Maintenance of Berkeley Way Project-Serving Components and other duties as set forth in more detail in Section 5.1 below.

12-19-2019

(i) "Berkeley Way Joint Policy" means the master policy (or policies) of primary property insurance coverage to be maintained by the Lessees covering the Project as set forth in more detail in Section 6.1 below.

(j) "Berkeley Way Reimbursement Assessment" has the meaning given in Section 5.6(b).

(k) "Berkeley Way Project Rules" means the rules that may be adopted by the Lessees from time to time, pursuant to Section 7.13 to address certain issues not fully addressed in this Declaration.

(l) "Berkeley Way Project-Serving Components" means (i) components of the Improvements that service all Lessee Parcels, such as the foundation, Roof, and the structural walls, and (ii) components of any system in the Improvements that services both the BRIDGE Affordable Parcel and both of the BFHP Hope Center Parcels. Components serving the BFHP Hope Center Parcels exclusively or just one Lessee Parcel exclusively do not constitute Project Serving Components under this Declaration. Berkeley Way Project-Serving Components include (without limitation and as applicable): the vertical shared wall separating the BRIDGE Affordable Development and the BFHP Hope Center Development; the Project generator, MPOE room (which is the main point of entry, or the first point where utilities enter the Project), hardscape and softscape adjacent to the sidewalk or street along the boundary of the Project (including landscaping), fire pump and sprinkler system, fire alarm and other life safety and security systems, water pump, irrigation and backflow preventer, those portions of reservoirs, tanks, pumps, motors, ducts, flues, chutes, conduits, pipes, plumbing, wires, and other utility installations contained within and immediately surrounded by or attached to any structure or space which is part of the Project and passes through more than one Lessee Parcel (as required to provide power, light, telephone, cable television, gas, water, sanitary sewerage, storm sewerage, and drainage services); window washing anchors; other usual appurtenances; and any other Project element which is not located solely within one Parcel and which the Lessees determine to be a Berkeley Way Project-Serving Component. For the purposes of this Agreement, the following will be considered Berkeley Way Project Serving Components, but subject to the provisions of Section 3.2(c) and (d), respectively: (i) the exterior walls and windows and (ii) the Southern Egress Easement area and improvements constructed thereon pursuant to the Plans and Specifications.

(m) "Berkeley Way Special Joint Expenses Assessment" has the meaning given in Section 5.5.

(n) "BFHP Hope Center Development" means the Permanent Supportive Housing Development and Temporary Housing Development located on the BFHP Hope Center Parcels.

(o) "BFHP Hope Center Ground Leases" means, collectively, the Permanent Supportive Housing Ground Lease and Temporary Housing Ground Lease, as either may be amended from time to time.



12-19-2019

- (p) "BFHP Hope Center Lessee" means the Permanent Supportive Housing Lessee and the Temporary Housing Lessee, or one of them as the context requires.
- (q) "BFHP Hope Center LLC" means BFHP Hope Center LLC, a California limited liability company.
- (r) "BFHP Hope Center Parcels" means, collectively, the Permanent Supportive Housing Parcel and the Temporary Housing Parcel portions of the Property designated as "Parcel A" and "Parcel B", respectively, on the Map.
- (s) "BFHP Hope Center Partnership" means BFHP Hope Center LP, a California limited partnership.
- (t) "BFHP Hope Center Project-Serving Component" means a Project-Serving Component located on one or both of the BFHP Hope Center Parcels.
- (u) "BRIDGE Affordable Development" means approximately eighty-nine (89) units of affordable multifamily housing units located on the BRIDGE Affordable Parcel.
- (v) "BRIDGE Affordable Ground Lease" means that certain ground lease entered in by and between the City and the BRIDGE Affordable Lessee for the BRIDGE Affordable Parcel, as amended from time to time.
- (w) "BRIDGE Affordable Lessee" means (i) the long term tenant or lessee of the BRIDGE Affordable Parcel pursuant to the BRIDGE Affordable Ground Lease, or a replacement thereof, as well as the successors or assigns of any such lessee, or (ii) if the BRIDGE Affordable Ground Lease expires or is terminated and is not replaced by a long term lease, the fee owner, from time to time, of the BRIDGE Affordable Parcel. BRIDGE Affordable Partnership is the initial BRIDGE Affordable Lessee.
- (x) "BRIDGE Affordable Parcel" means the portion of the Property designated as "Parcel C" on the Map.
- (y) "BRIDGE Affordable Partnership" means BRIDGE Berkeley Way LP, a California limited partnership.
- (z) "BRIDGE Affordable Project-Serving Component" means a Project-Serving Component located on the BRIDGE Affordable Parcel.
- (aa) "City" has the meaning set forth in the preamble of this Declaration.
- (bb) "CPI" has the meaning set forth in Section 7.5(b).
- (cc) "Declaration" means this Declaration of and Agreement Regarding Covenants, Conditions and Restrictions Providing Reciprocal Easements, Joint Use and

12-19-2019

Maintenance for Berkeley Way, and all amendments, modifications and supplements executed in accordance herewith.

(dd) "Designated Share" means the following percentages for the Maintenance of the Berkeley Way Project-Serving Components (which were calculated based upon the gross square footage of the Parcels):

BRIDGE Affordable Lessee	64%
Permanent Supportive Housing Lessee	27%
Temporary Housing Lessee	9%

Notwithstanding the forgoing, the Designated Share paid by a Lessee may be modified by the Lessees (and with the consent of the City) for costs associated with Berkeley Way Project-Serving Components which benefit more than one but not all of the Lessees or which are later determined to provide disproportionate benefit to one or more Lessee shall be allocated in an equitable manner solely among the benefited Lessees.

(ee) "Easements" means the Map Easements and the Project Easements.

(ff) "Encroachments" means minor encroachments among the Parcels due to any of the following: engineering errors; errors in original construction, reconstruction, or repair; settlement, shifting or movement of the Improvements; the insertion of nails, screws, or similar hardware through a boundary between the Parcels for the purpose of securing an item; or any similar cause.

(gg) "Improvements" means, collectively, the BRIDGE Affordable Development and the BFHP Hope Center Development, and all other improvements and fixtures that may be built on and/or installed in any of the Lessee Parcels from time to time, including landscaping.

(hh) "Leases" means the BRIDGE Affordable Ground Lease and the BFHP Hope Center Ground Leases.

(ii) "Lessee" means (i) the BRIDGE Affordable Lessee, (ii) the Permanent Supportive Housing Lessee and (iii) the Temporary Housing Lessee, (each being referred to herein as a "Lessee" and collectively referred to as the "Lessees").

(jj) "Lessee Parcel" means any of the BRIDGE Affordable Parcel, the Permanent Supportive Housing Parcel, and the Temporary Housing Parcel (each being referred to herein as a "Lessee Parcel" and collectively referred to as "Lessee Parcels").

(kk) "Maintain" means undertake Maintenance.

(ll) "Maintenance" means the maintaining (including cleaning and routine, day to day, janitorial services), repairing and replacing of any improvement on a

12-19-2019

Parcel (including a Project-Serving Component), or related to an Easement.

(mm) "Map" means that certain parcel map entitled Parcel Map No. 11051 filed in the Official Records on \_\_\_\_\_, 2020 as file number \_\_\_\_\_, subdividing the Property into the Parcels, a copy of which is attached to this Declaration as Exhibit B and incorporated herein.

(nn) "Map Easements" mean the easements granted by Berkeley Way Declarants through the Map.

(oo) "Mortgage" means a recorded mortgage or deed of trust encumbering a Lessee Parcel, which is given as security by a Lessee for the payment of money or performance of an obligation.

(pp) "Mortgagee" means any Person, bank, savings and loan association, insurance company, or other financial institution that is either a mortgagee under a mortgage or the beneficiary under a deed of trust and any holder, governmental guarantor, or insurer of any such mortgage or deed of trust.

(qq) "Official Records" means the Official Records of the County of Alameda, State of California.

(rr) "Parcels" means the Lessee Parcels.

(ss) "Permanent Supportive Housing Development" means approximately fifty-three (53) supportive housing units located on the Permanent Supportive Housing Parcel.

(tt) "Permanent Supportive Housing Ground Lease" means that certain ground lease entered into by and between the City and the BFHP Hope Center Partnership for the Permanent Supportive Housing Parcel, as amended from time to time.

(uu) "Permanent Supportive Housing Lessee" means (i) the long term lessee of the Permanent Supportive Housing Parcel pursuant to the Permanent Supportive Housing Ground Lease, or a replacement thereof, as well as the successors or assigns of any such lessee, or (ii) if the Permanent Supportive Housing Ground Lease expires or is terminated and is not replaced by a long term lease, the fee owner, from time to time, of the Permanent Supportive Housing Parcel. The BFHP Hope Center partnership is the initial Permanent Supportive Housing Lessee.

(vv) "Permanent Supportive Housing Parcel" means the portion of the Property designated as "Parcel A" on the Map.

(ww) "Person" means a natural person, a corporation, a partnership, a limited liability company, a trust, or other legal entity.

(xx) "Plans and Specifications" means the plans and specifications for

12-19-2019

the applicable portion of the Project last dated as of \_\_\_\_\_, 20\_\_ prepared by \_\_\_\_\_, together with such changes thereto as may have been made in connection with the approval thereof by any regulatory body having jurisdiction to approve such plans and specifications.

(yy) "Project" means, collectively, the BRIDGE Affordable Parcel, the BFHP Hope Center Parcels, and all Improvements constructed on such Parcels.

(zz) "Project Easements" means the easements granted through this Declaration. The Project Easements will be described in this Declaration by function or location rather than by precise measurement on the Map or the Plans and Specifications.

(aaa) "Property" means that certain real property described in Exhibit A.

(bbb) "REA 2" is defined in Recital F.

(ccc) "Reimbursement Expense" has the meaning given in Section 5.6(a).

(ddd) "Roof" means the waterproof membrane on the uppermost surface of the Project which is exposed to the elements together with the load bearing structure that supports such membrane. The Roof covers and is contained in the BRIDGE Affordable Parcel and the Permanent Supportive Housing Parcel and is a Project-Serving Component.

(eee) "Southern Egress Easement" is defined in Section 2.4.

(fff) "Temporary Housing Development" means approximately forty-four (44) beds of temporary housing, community kitchen and dining hall.

(ggg) "Temporary Housing Ground Lease" means that certain ground lease to be entered into by and between the City and the Temporary Housing Lessee for the Temporary Housing Parcel, as amended from time to time.

(hhh) "Temporary Housing Lessee" means (i) the long term lessee of the Temporary Housing Parcel pursuant to Temporary Housing Ground Lease, or a replacement thereof, as well as the successors or assigns of any such lessee, or (ii) if the Temporary Housing Ground Lease expires or is terminated and is not replaced by a long term lease, the fee owner, from time to time, of the Temporary Housing Parcel. The BFHP Hope Center Partnership is the initial Temporary Housing Lessee, but the parties anticipate that BFHP Hope Center LLC will be the Temporary Housing Lessee following completion of construction and issuance of the IRS Form 8609 (Low Income Housing Tax Credit Allocation and Certification) for the Permanent Supportive Housing Development.

(iii) "Temporary Housing Parcel" means the portion of the Property designated as "Parcel B" on the Map.

12-19-2019

(jjj) "Users" means a Lessee's employees, tenants, lessees, guests, licensees, invitees, contractors and subcontractors.

1.2 Exhibits. The following exhibits are attached to and incorporated into this Declaration:

Exhibit A	Legal Description of the Property
Exhibit B	Parcel Map

## ARTICLE 2 DIVISION OF PROPERTY, GRANT OF EASEMENTS

### 2.1 General Description of Property.

(a) General Boundaries. Each of the Parcels has the boundaries shown on the Map.

(b) BRIDGE Affordable Parcel. The BRIDGE Affordable Parcel will contain the BRIDGE Affordable Development to be developed by the BRIDGE Affordable Partnership.

(c) BFHP Hope Center Parcels. The BFHP Hope Center Parcels will contain the BFHP Hope Center Development to be developed by the BFHP Partnership. The BFHP Hope Center Parcels are comprised of the Permanent Supportive Housing Parcel and the Temporary Housing Parcel.

2.2 No Separate Conveyance of Easements. The ownership of each of the Parcels includes the benefit of, and is encumbered by and is subject to the Easements, as applicable. The Project Easements are (i) established through this Declaration and are to be conveyed, as applicable, with each of the Lessee Parcels (ii) cannot be modified, terminated or relocated (except as set forth in this Declaration), and (iii) may not be separated or separately conveyed. The benefit and burden of each Easement, as applicable, shall be deemed to be conveyed with its respective Parcel, even though the description in the instrument of conveyance may refer only to the fee or leasehold title to such Parcel. The Easements are essential and necessary for the development and ongoing operation of the Improvements.

2.3 Grant of Easements. Through this Declaration, the Berkeley Way Declarants hereby grant and establish the following easements affecting the Project and the Parcels.

(a) Easements for Construction and Maintenance. Each Lessee is hereby granted, and each Lessee Parcel shall have the benefit of and shall be burdened by, a non-exclusive easement in, on, under, over and across each Lessee Parcel for the purpose of (i) construction or installation and Maintenance of the Improvements within each Lessee Parcel, (ii) repair, restoration, or reconstruction following a casualty affecting all or a portion of the Improvements, (iii) Maintenance of encroachments in which easements are granted in Section 2.3(e), and (iv) Maintenance

12-19-2019

of Improvements within any Lessee Parcel to the extent that performance of such Maintenance is the responsibility or right of another Lessee under Article 3. The exercise of the easements granted in this Section shall be made with as little inconvenience to each Lessee as practicable. Except in cases of emergency prior to exercise of any easement rights granted in this Section, not less than forty-eight (48) hours' advance notice (by telephonic notice together with any one of: (i) overnight delivery, (ii) electronic mail and overnight delivery, or (iii) personal delivery) shall be given to any Lessee whose Parcel will be affected by the exercise of such rights. Any damage to any portion of any of the Parcels as a result of the exercise of the easement rights granted in this Section shall be promptly restored to as near the original condition as possible by the Lessee utilizing the easement at such Lessee's sole cost and expense. The easements granted in this Section are of a temporary nature and the rights hereunder may only be exercised during the relevant period of construction, repair, restoration, reconstruction, or Maintenance.

(i) Safety Matters; Legal Compliance. Each Lessee shall take, and shall cause its agents and contractors to take, all safety measures necessary to protect the other Lessees and their Users and the property of each from injury or damage caused by or resulting from the any construction, repair, restoration, reconstruction or Maintenance undertaken by or on behalf of such Lessee pursuant to the foregoing grant of easement. Each Lessee agrees that all construction work performed hereunder by or on behalf of such Lessee shall be done in a diligent, good and workmanlike manner, with first-class materials and in accordance with approved drawings and specifications (including the Plans and Specifications, as applicable) and all applicable laws, rules, ordinances, regulations, and code requirements.

(ii) Liens. Each Lessee agrees that in the event that any mechanic's lien or other statutory lien arising by reason of labor, services or materials supplied to or at the request of said Lessee shall be recorded against any Parcel other than such Lessee's Parcel, then such Lessee shall pay and discharge the same of record within twenty (20) days after the notice of the filing thereof, by either payment, deposit or bond. Each Lessee shall have the right, but not the obligation, to contest the validity, amount or applicability of any such lien by appropriate legal proceedings, provided it furnishes a lien release bond or otherwise causes such lien to be released of record within such twenty (20) day period. If said Lessee does not, within the time period specified above, cause such lien to be released of record by payment or posting of a proper bond, the Lessee of the Lessee Parcel affected by such lien shall have, in addition to all other remedies provided herein and by law, the right, but not the obligation, to cause the same to be released by such means as such Lessee shall deem proper, including, without limitation, by the payment of the claim giving rise to such lien or by the posting of a bond. The Lessee of the Lessee Parcel affected by such lien shall submit an invoice and supporting documentation to the responsible Lessee and the responsible Lessee shall pay such amount no later than ten (10) days following receipt of such invoice.

(b) Utility Easements. Each Lessee is hereby granted, and each Lessee Parcel shall have the benefit of and shall be burdened by, such non-exclusive

12-19-2019

easements and rights in, on, under, over and across those portions of each of the Lessee Parcels, and the utility rooms identified on the Plans and Specifications, that are reasonably necessary for each Lessee to access, install, operate, maintain, repair, replace and relocate all electrical, gas, water, sewage, drainage, telephone, cable, security, generators, life safety equipment and other utilities and similar facilities identified in the Plans and Specifications and servicing the Lessee Parcel of each Lessee. The exercise of the easements granted in this paragraph shall be made with as little inconvenience to each Lessee as practicable. Except in cases of emergency prior to exercise of any easement rights granted in this paragraph (including but not limited to access to the MPOE and water pump room), not less than forty-eight (48) hours' advance notice (by telephonic notice together with any one of and: (i) overnight delivery, (ii) electronic mail and overnight delivery, or (iii) personal delivery) shall be given to any Lessee whose Parcel will be affected by the exercise of such rights. Any utility work shall be at the sole cost and expense of the Lessee contracting for the performance of the work. Any damage to any portion of any of the Parcels as a result of the exercise of the easement rights granted in this Section shall be promptly restored to as near the original condition as possible by the Lessee utilizing the easement at such Lessee's sole cost and expense.

(c) Structural and Support Easements. Each Lessee is hereby granted, and each Lessee Parcel shall have the benefit of and shall be burdened by, such non-exclusive easements and rights in, on, under, over, and across each Lessee Parcel as reasonably necessary for the structural support and integrity of the Improvements located within each Lessee Parcel, with such easements and rights being appurtenant to each Lessee Parcel. No Lessee shall perform, or shall permit the performance of, any activity that may materially alter the structural support necessary for the Improvements located within the Lessee Parcel(s) owned by any other Lessee(s) without the consent of the other Lessee(s).

(d) Encroachment Easements. Each Lessee is hereby granted, and each Lessee Parcel shall have the benefit of and shall be burdened by, such non-exclusive easements and rights in, on, under, over, and across each Lessee Parcel as reasonably necessary to accommodate and maintain any Encroachment that may now or hereafter exist. Notwithstanding the forgoing, no Lessee shall have the benefit of an easement for an Encroachment as a result of the negligence or willful misconduct of such Lessee or its Users. If the Improvements are partially or totally destroyed, and then repaired or rebuilt in substantially the same manner as originally constructed, minor encroachments shall be permitted to facilitate repair or reconstruction.

#### 2.4 Egress Easements.

(a) Subject to the terms and conditions in that certain Grant Deed dated September 6, 1955, recording in the Official Records of Alameda County on September 21, 1955 at Book 7788 pages 3-5 (the "Southern Egress Easement Deed"), the Property is subject to a non-exclusive egress easement, three feet wide and seven feet in height, from the Southern Parcels to Berkeley Way for fire escape purposes (the "Southern Egress Easement"). The current location of the Southern Egress Easement is

12-19-2019

shown on the Map. Subject to the terms of the Southern Egress Easement Deed, Lessees will allow access from the parcels benefited by the Southern Egress Easement and identified in the Southern Egress Easement Deed (the "Southern Parcels"); provided that the Lessees may take reasonable measures to prevent the Southern Egress Easement from being utilized as an entrance to the Southern Parcels or (except for emergencies) exit egress from the Southern Parcels. The Southern Egress Easement may also be used by the Lessees for emergency exit.

(b) The BRIDGE Affordable Parcel and Supportive Housing Parcel will also meet City requirements to provide emergency exit egress to Lot 9 and 10 as such lots are shown on page 2 of the Map.

(c) The BRIDGE Affordable Parcel will also meet City requirements to provide emergency exit egress to Lot 57 and 58 as such lots are shown on page 2 of the Map.

## 2.5 Hold Harmless.

(a) Each Lessee (an "Indemnifying Lessee") shall indemnify, defend, and hold each of the other Lessees (the "Indemnified Lessees") harmless from all liability, damage, cost, or expense incurred by any of the Indemnified Lessees arising out of the utilization by the Indemnifying Lessee or any of its Users of any of the Easements within any such Indemnified Lessee's Lessee Parcel, or arising out of any violation by such Indemnifying Lessee of its obligations under this Declaration, except to the extent that any such liability, damage, cost or expense results from the negligence or willful misconduct of the Indemnified Lessee.

(b) Each Lessee shall indemnify, defend, and hold each of the other Lessees harmless from all liability, damage, cost, or expense incurred by any such other Lessee arising out of any liens, including, but not limited to, mechanics' and materialmen's liens, imposed on the Lessee Parcel of such other Lessee as a consequence of any work or labor done, supplies furnished, or services rendered at the request of the contracting Lessee or any of its Users.

(c) Each Lessee shall cause any property insurance policy obtained by it to provide that the insurance company waives all right of recovery by way of subrogation against any other Lessee in connection with any damage covered by such property insurance policy to the personal and real property improvements located in or on the Lessee Parcel or such other Lessee and/or the Project that are caused by or result from risks insured against under any property insurance policies carried by such Lessee and in force at the time of any such damage.



12-19-2019

ARTICLE 3  
MAINTENANCE AND ALTERATIONS

3.1 Maintenance of the Lessee Parcels.

(a) Maintenance of the BRIDGE Affordable Parcel. Maintenance of the BRIDGE Affordable Parcel shall be performed as follows:

(i) Maintenance of the BRIDGE Affordable Parcel and the BRIDGE Affordable Development, including the BRIDGE Affordable Berkeley Way Project-Serving Components shall be performed by the BRIDGE Affordable Lessee in accordance with this Declaration and the BRIDGE Affordable Ground Lease. The BRIDGE Affordable Lessee shall manage, maintain in good condition, repair, and replace the Improvements (which includes landscaping and the courtyards) on the BRIDGE Affordable Parcel, except for those items (if any) which another Lessee has been designated to manage, maintain, repair, and replace as described in this Declaration.

(ii) Each of the other Lessees shall have the right to perform Maintenance of the BRIDGE Affordable Parcel to the extent necessary to mitigate an emergency situation. Before performing Maintenance under this paragraph, the other Lessee shall first take all reasonable steps to contact the BRIDGE Affordable Lessee to permit the BRIDGE Affordable Lessee to perform the necessary Maintenance.

(iii) Except as provided in Section 3.1(c) and (d), and Section 3.2, the cost of Maintenance of the BRIDGE Affordable Parcel shall be borne by the BRIDGE Affordable Lessee; provided that failure of the other Lessees to tender their respective cost amounts shall not relieve BRIDGE Affordable Lessee from performing its required Maintenance under this Declaration.

(b) Maintenance of the BFHP HOPE Center Parcels. Maintenance of the BFHP Hope Center Parcels shall be performed as follows:

(i) Maintenance of the BFHP Hope Center Parcels and the BFHP Hope Center Development, including the applicable BFHP Hope Center Berkeley Way Project-Serving Components, shall be performed by the applicable BFHP Hope Center Lessee in accordance with this Declaration and the REA 2. Provisions of the REA 2 concerning the BFHP Hope Center Parcels Berkeley Way Project-Serving Components may not be amended or modified unless consented to by the City and the BRIDGE Affordable Lessee. Each BFHP Hope Center Lessee, as applicable under the REA 2, shall manage, maintain in good condition, repair, and replace the Improvements (which includes landscaping and the courtyards) on the BFHP Hope Center Parcels, except for those items (if any) which another Lessee has been designated to manage, maintain, repair, and replace as described in this Declaration.

(ii) Each of the other Lessees shall have the right to perform Maintenance of a BFHP Hope Center Parcels to the extent necessary to mitigate an

12-19-2019

emergency situation. Before performing Maintenance under this paragraph, the other Lessee shall first take all reasonable steps to contact the applicable BFHP Hope Center Lessee to permit such BFHP Hope Center Lessee to perform the necessary Maintenance.

(iii) Except as provided in Section 3.1(c) and (d) and Section 3.2, the cost of Maintenance of each BFHP Hope Center Parcel shall be borne by the applicable BFHP Hope Center Lessee, pursuant to the REA 2; provided that failure of the other Lessees to tender their respective cost amounts shall not relieve BFHP Hope Center Lessees from performing its required Maintenance under this Declaration.

(c) Cost of Maintenance of Berkeley Way Project-Serving Components. The cost of Maintenance of the Berkeley Way Project-Serving Components shall be borne by the Lessees in their Designated Shares.

(d) Cost for Maintenance Caused by Another Lessee. Subject to Section 2.4(c), the cost of any Maintenance of any Parcel required as a result of any act or omission (including without limitation failure to timely perform its own maintenance obligations) of another Lessee or its Users shall be borne solely by such Lessee.

### 3.2 Specific Maintenance.

(a) Each Lessee will coordinate its repair and maintenance of any Berkeley Way Project-Serving Components with the Berkeley Way Joint Maintenance Committee. Costs to maintain and repair Berkeley Way Project-Serving Components shall be allocated in a manner consistent with Section 5.3(c).

(b) BRIDGE Affordable Lessee will manage the maintenance of all exterior landscaping adjacent to the sidewalk or street along the boundary of the Project, the Roof, foundation and exterior walls (all of which are Berkeley Way Project-Serving Components), on behalf of the Lessees, the costs of which will be a Berkeley Way Joint Expense.

(c) BRIDGE Affordable Lessee and the Permanent Supportive Housing Lessee will jointly manage window washing and the costs of such washing will be shared in accordance with each Lessee's Designated Share. Notwithstanding anything to the contrary in this Declaration or the BFHP Hope Center Declaration, other Maintenance of the windows (including repair of any broken or leaking windows) will be the sole responsibility of the Lessee on whose parcel the window is located.

(d) Permanent Supportive Housing Lessee will manage the maintenance of the Southern Egress Easement and all improvements (including the lights and gates) thereon, the costs of which will be a Berkeley Way Joint Expense. Notwithstanding anything to the contrary in this Declaration or the BFHP Hope Center Declaration, Maintenance costs of the Southern Egress Easement will be allocated as follows: 70% to the BFHP Hope Center and 30% to the BRIDGE Affordable Parcel. In addition, the Lessees may seek reimbursement from the Southern Parcel owners pursuant to the Southern Access Easement Deed.

12-19-2019

3.3 Prohibited Alterations; Alterations to Berkeley Way Project-Serving Components.

(a) Subject to the requirements of the Leases, no Lessee shall, without the prior written consent of the other Lessees, construct or alter any Improvements on such Lessee's Parcel that will do any of the following:

(i) Unreasonably interfere with any other Lessee's use and enjoyment of its Lessee Parcel;

(ii) Cause the termination or nonrenewal of insurance policies or an increase in insurance premiums for another Lessee;

(iii) Adversely affect or impair the architectural integrity of the Project or the exterior of the Project;

(iv) Interfere with or alter the fire or acoustical rating of any wall separating a Lessee Parcel from another Lessee Parcel; or

(v) Violate the Lessee's Lease.

(b) Prior to performing any alteration to any Project-Serving Component located on a Lessee Parcel (except for cosmetic alterations, such as painting, that are not visible from the exterior of the Project), the Lessee proposing to undertake the alteration shall:

(i) Provide the other Lessees copies of the plans and specifications for the work to be performed; and

(ii) Request and obtain the written approval of the other Lessees, which approval shall not be unreasonably withheld, conditioned, or delayed.

ARTICLE 4  
USE RESTRICTIONS

In addition to all of the covenants contained in this Declaration and in the Leases, the use of the Property is subject to the following:

4.1 BRIDGE Affordable Parcel. The BRIDGE Affordable Parcel shall be occupied and used for residential and related purposes, including but not limited to, affordable multi-family housing apartment purposes. No other trade or business shall be conducted therein, except as follows: (1) secondary use not incompatible with residential use such as an "office in the home," (2) management offices and use of residential units for resident manager's units and assistant residential manager's units, (3) use of residential units, common areas, and offices for the provision of supportive services to the residents of the residential units, (4) other ground floor uses then consistent with zoning.

12-19-2019

4.2 BFHP Hope Center Parcels. The BFHP Hope Center Parcels shall be occupied and used for residential and social or community serving purposes then consistent with zoning. Declarant intend for the BFHP Hope Center Parcel to be used as follows: (a) the Permanent Supportive Housing Parcel shall be used for supportive housing and other community services uses including a kitchen and meal service and (b) the Temporary Housing Parcel shall be used for temporary housing, community and supportive and related office space, and other community and supportive services. No other trade or business shall be conducted therein, except as follows: (1) secondary use not incompatible with residential use such as an "office in the home," (2) management offices and use of residential units for resident manager's units and assistant residential manager's units, (3) use of common areas, and offices for the provision of supportive services to the residents of the residential units and homeless and low income community members.

4.3 Compliance with Laws; No Nuisances. Each Lessee shall comply with, and shall make diligent efforts to cause all Users to comply with, at all times, all applicable laws, rules, ordinances, regulations, and code requirements governing its Lessee Parcel, specifically and the Property generally. Nothing shall be done on any Lessee Parcel which will impair the structural integrity of the Project or which constitutes a nuisance or interferes with the quiet enjoyment of the other Lessees or the Lessee Parcels. No illegal activities will be carried on, in or upon the Property. Each Lessee shall also be responsible for the costs of any false alarms triggered by such Lessee's Users and resulting in any fines, costs or fees.

4.4 Signs. Signs on each Lessee Parcel shall conform to any applicable City ordinances and shall be subject to any applicable Berkeley Way Project Rules. Signs of a reasonable size advertising any residential or otherwise permitted retail unit (if any) for rent may be displayed to the public view, provided such signs comply with the City ordinances.

4.5 Telecommunications Equipment and Roof Mounted Equipment. Other than what is shown on the Plans and Specifications or otherwise required by law and subject to the applicable Leases, no telecommunications equipment or roof mounted equipment of any sort may be put on the Roof or the exterior of the Project without the prior written consent of the Lessees.

4.6 Garbage and Refuse Disposal. All rubbish, trash, and garbage shall be regularly removed from the Property, and shall not be allowed to accumulate. Trash, garbage, and other waste shall be kept in sanitary containers. All equipment for the storage or disposal of such materials shall be kept in a clean and sanitary condition. All equipment, garbage cans, or storage piles shall be kept screened and concealed from view of streets, and open spaces in the Lessee Parcels. Each Lessee shall be responsible for the storage and disposal of the rubbish, trash, and garbage generated from the activities occurring on its Lessee Parcel.

12-19-2019

ARTICLE 5  
JOINT MAINTENANCE EXPENSES, ASSESSMENTS AND RESERVES

5.1 Berkeley Way Joint Maintenance Committee. The BRIDGE Affordable Lessee will appoint one representative to serve as a member of the Berkeley Way Joint Maintenance Committee. Pursuant to the procedures set forth in the REA 2, the BFHP Hope Center Lessee will appoint one representative to serve as a member of the Berkeley Way Joint Maintenance Committee. Each member of the Berkeley Way Joint Maintenance Committee may be removed from office at any time by his/her appointing Lessee with or without cause. Any member of the Berkeley Way Joint Maintenance Committee may resign at any time by giving written notice to the appointing Lessee and the Berkeley Way Joint Maintenance Committee.

(a) Meetings. The Berkeley Way Joint Maintenance Committee shall meet annually, no later than August 1 of each year, and at such other times as the members of the Berkeley Way Joint Maintenance Committee may determine. Both members of the Berkeley Way Joint Maintenance Committee must be present to conduct business and approve actions.

(b) Compensation. No member of the Berkeley Way Joint Maintenance Committee shall receive compensation for any service he or she may render to the Berkeley Way Joint Maintenance Committee.

(c) Duties. The duties of the Berkeley Way Joint Maintenance Committee shall include (i) coordination of maintenance of the Berkeley Way Project-Serving Components, and coordination of repair after damage or destruction to the Project (Section 5.2 below); (ii) preparation of the Berkeley Way Annual Joint Expenses Budget (Section 5.3 below); (iii) establishing, levying and collecting Berkeley Way Joint Assessments (Sections 5.4 and 5.5 below); (iv) establishing and monitoring reserves for reasonably anticipated contingencies and repairs or replacements of Berkeley Way Project-Serving Components (Section 5.8 below); and (v) oversight of the Berkeley Way Joint Policy for the Project (Article 6).

(d) Limitation of Liability. The members of the Berkeley Way Joint Maintenance Committee shall not be liable to the Lessees, their Users, or other person for any injury, death, loss or damage due to theft, other breaches of security, failures, or interruption of services, or other circumstances pertaining to activities within the Berkeley Way Joint Maintenance Committee's control. Each member of the Berkeley Way Joint Maintenance Committee shall be entitled to indemnification by the Lessees against all expenses, judgments, fines, settlements and other amounts actually and reasonably incurred in connection with any proceeding to which such member may be a party, or in which such member may become involved, by reason of the fact that he or she was or is a member of the Berkeley Way Joint Maintenance Committee.

12-19-2019

## 5.2 Coordination of Berkeley Way Joint Maintenance and Repair after Damage or Destruction.

(a) Maintenance Coordination. The Berkeley Way Joint Maintenance Committee is authorized to coordinate Maintenance of and provide service to, and assure that, each Project-Serving Component is operated, maintained, repaired, and replaced in a first-class condition, and otherwise in accordance with the standards and provisions of this Declaration. Such authorization includes the right to inspect and monitor each Lessee's Maintenance of Berkeley Way Project-Serving Components located on their respective Lessee Parcel, coordinate Maintenance among Lessees, and authorize contracts to perform any Maintenance the Committee reasonably determines is not being properly performed.

(b) Damage or Destruction Repair Coordination. The Berkeley Way Joint Maintenance Committee is authorized to coordinate the repair or restoration activities necessitated by damage or destruction affecting more than one Lessee Parcel, subject to the rights of Mortgagees. The Berkeley Way Joint Maintenance Committee shall have the right to authorize contracts to perform any repair or restoration work the Berkeley Way Joint Maintenance Committee reasonably determines is not being properly performed.

(c) Contracting. The BRIDGE Affordable Lessee (or any other Lessee or property management agent selected by the Berkeley Way Joint Maintenance Committee), as the agent of the Berkeley Way Joint Maintenance Committee, shall have the right but not the obligation to solicit bids, enter into contracts with third parties on behalf of the Berkeley Way Joint Maintenance Committee, and take all other steps reasonably necessary or appropriate to perform the duties of the Berkeley Way Joint Maintenance Committee consistent with the then-current Berkeley Way Annual Joint Expenses Budget or as otherwise authorized to be undertaken by the Berkeley Way Joint Maintenance Committee; provided, however, that if the activities of the Berkeley Way Joint Maintenance Committee are necessitated by a Lessee not performing its required Maintenance, repair or restoration activities, the costs incurred by the Berkeley Way Joint Maintenance Committee to perform such activities shall be a Berkeley Way Reimbursement Assessment charged pursuant to Section 5.6 below.

## 5.3 Berkeley Way Annual Joint Expenses Budget.

(a) By September 1 of each year, the Berkeley Way Joint Maintenance Committee shall meet to discuss the Berkeley Way Joint Expenses that the Lessees expect to be incurred in the following calendar year. By October 1, the Berkeley Way Joint Maintenance Committee shall prepare and deliver to the Lessees a written budget describing in reasonable detail the Berkeley Way Joint Expenses that the Lessees expect to be incurred in the following calendar year (the "Berkeley Way Annual Joint Expenses Budget"). The Berkeley Way Annual Joint Expenses Budget shall also specify the contribution that each Lessee must make, during the following calendar year, to its reserve account pursuant to Section 5.8(b).

12-19-2019

(b) The Berkeley Way Annual Joint Expenses Budget shall account for all expected ordinary and extraordinary Berkeley Way Joint Expenses to be incurred in a calendar year, including expenses expected to be incurred by the Berkeley Way Joint Maintenance Committee for management, accounting or other services, and (ii) any previously unreconciled past payments of Berkeley Way Reimbursement Assessments for Berkeley Way Joint Expenses or Berkeley Way Joint Expenses Assessments for Reimbursement Expenses. The Berkeley Way Annual Joint Expenses Budget shall also describe the following: (1) the current estimated replacement cost, estimated remaining life, and estimated useful life of each major component the Maintenance of which is a Berkeley Way Joint Expense; (2) the current estimate of the amount of cash reserves necessary to perform Maintenance on such major components; (3) the current estimate of accumulated cash reserves actually set aside by the Lessees to perform Maintenance on such major components (as further discussed in Section 5.8); and (4) a statement addressing the procedures used for the calculation and establishment of those reserves to defray the Maintenance of major components the Maintenance of which is a Berkeley Way Joint Expense.

(c) The Berkeley Way Annual Joint Expenses Budget shall allocate Berkeley Way Joint Expenses to each Lessee in proportion to their Designated Shares.

(d) Unless one or more of the Lessees objects in writing in a timely manner to the Berkeley Way Annual Joint Expenses Budget pursuant to Section 5.3(e) below, the Berkeley Way Annual Joint Expenses Budget shall be effective as of January 1 of the following year.

(e) If any affected Lessee disputes the Annual Berkeley Way Joint Expense Budget proposed by the Berkeley Way Joint Maintenance Committee and the Lessees are unable to resolve their differences within a reasonable time, then the parties shall submit the Berkeley Way Annual Joint Expenses Budget in question to an arbitrator jointly selected by the parties (or if the Lessees cannot agree on an arbitrator, then each Lessee will select an arbitrator and the selected arbitrators will select a third arbitrator and the third arbitrator shall be the arbitrator to resolve the dispute over the Berkeley Way Annual Joint Expenses Budget). By December 25, the arbitrator shall confirm or revise the Berkeley Way Annual Joint Expenses Budget as the arbitrator determines to be appropriate, and such confirmed or revised Berkeley Way Annual Joint Expenses Budget shall be effective as of January 1 of the following year. The fees of the arbitrator or arbitrators shall be a Berkeley Way Joint Expense, but any other costs incurred in connection with the arbitration shall be borne by the Lessee incurring such costs.

#### 5.4 Berkeley Way Joint Expenses Assessments.

(a) Each Lessee's Designated Share of Berkeley Way Joint Expenses, as set forth in the Berkeley Way Annual Joint Expenses Budget from time to time, shall be a charge levied against such Lessee and its Lessee Parcel and may be collected as a "Berkeley Way Joint Expenses Assessment", enforceable in the manner set forth in Section 5.7.

12-19-2019

(b) The Berkeley Way Joint Maintenance Committee will, from time to time, select a Lessee to receive and hold, in trust, the Berkeley Way Joint Expenses Assessments, and make disbursement thereof for the payment of Berkeley Way Joint Expenses. Each Lessee shall pay its annual Berkeley Way Joint Expenses Assessment in even monthly installments equal to one twelfth (1/12) of its annual Berkeley Way Joint Expenses Assessment, with each monthly installment due on the first day of each month of the year for which the applicable Berkeley Way Annual Joint Expenses Budget is effective. Notwithstanding the forgoing, the Berkeley Way Joint Maintenance Committee may request even quarterly payments in lieu of monthly payments. In addition, in lieu of collecting Berkeley Way Joint Expenses Assessments (either in whole or in part), the Lessees may also choose and the Joint Maintenance Committee may require reimbursement of or payment to any Lessee who pays for or coordinates maintenance of a Berkeley Way Joint Expense.

(c) The Berkeley Way Joint Maintenance Committee shall oversee the use of the Berkeley Way Joint Expense Assessments received from the Lessees pursuant to Section 5.4(b), and the performance of the activities whose costs constitute Berkeley Way Joint Expenses.

5.5 Berkeley Way Special Joint Expenses Assessments. In the event the Berkeley Way Joint Maintenance Committee determines, in good faith, that the Berkeley Way Annual Joint Expenses Budget is or will become inadequate for any reason (including, but not limited to, misinformation or miscalculation, unexpected repair or replacement of any Project-Serving Component, increase in estimates of Berkeley Way Joint Expenses, or increase in the cost of the Berkeley Way Joint Policy, the Berkeley Way Joint Maintenance Committee may, at any time, levy an assessment (the "Berkeley Way Special Joint Expenses Assessment") to make up such inadequacy, which shall be allocated to the Lessee(s) in accordance with the Designated Shares (or in the event of an increase in the cost of the Berkeley Way Joint Policy due to the actions or failure to act of one or more, but not all of the Lessees, to be divided solely among the Lessees responsible for the increase in insurance as further set forth in Article 6).

5.6 Berkeley Way Reimbursement Assessments.

(a) A "Reimbursement Expense" is, subject to Section 5.8(b), any expense actually incurred or expected to be incurred by a Berkeley Way Creditor Lessee that:

(i) is the financial responsibility of a Berkeley Way Debtor Lessee under this Declaration;

(ii) arises out of noncompliance with this Declaration (or any rule or regulation duly adopted pursuant to this Declaration) by the Berkeley Way Debtor Lessee; or

(iii) arises out of inaction by the Berkeley Way Debtor Lessee that does not constitute noncompliance with this Declaration.



12-19-2019

(b) Every Reimbursement Expense shall be a charge levied against the Berkeley Way Debtor Lessee and against the Debtor's Lessee Parcel, as applicable (a "Berkeley Way Reimbursement Assessment").

(c) Reimbursement Expenses shall include actual and reasonable financing costs associated with the Berkeley Way Creditor Lessee advancing funds on behalf of the Berkeley Way Debtor Lessee from the time funds are advanced until the date on which the applicable Berkeley Way Reimbursement Assessment is paid.

(d) Berkeley Way Reimbursement Assessments shall be enforced in the manner set forth in Section 5.7.

#### 5.7 Payment and Enforcement of Assessments.

(a) A Berkeley Way Creditor Lessee shall provide notice to a Berkeley Way Debtor Lessee of the amount and due date of any Berkeley Way Assessment. Notice shall be delivered not less than thirty (30) and not more than sixty (60) days prior to the Berkeley Way Assessment becoming due.

(b) Each Berkeley Way Assessment obligation is a personal obligation of the Berkeley Way Debtor Lessee against whom the Berkeley Way Assessment is levied. Berkeley Way Assessments may be offset against each other unless one Lessee objects in writing to an offset.

(c) Any Berkeley Way Assessment shall become delinquent if not paid within fifteen (15) days after the due date, and a Berkeley Way Creditor Lessee's reasonable costs in collecting the delinquent Berkeley Way Assessment (including reasonable attorneys' fees) may then be added to the Berkeley Way Assessment. Any Berkeley Way Assessment remaining unpaid as of thirty (30) days after the due date shall also have the following charges added to the Berkeley Way Assessment (together with the reasonable costs of collection, the "Additional Charges"): (i) interest at the lesser of twelve percent (12%) per annum and the maximum lawful rate; and (ii) a late charge equal to the greater of Ten Dollars (\$10) and ten percent (10%) of the delinquent Berkeley Way Assessment.

(d) If any Berkeley Way Assessment is not paid within thirty (30) days after its due date, then the Berkeley Way Creditor Lessee shall provide notice to the Berkeley Way Debtor Lessee (and shall simultaneously notify any Mortgagee who has requested a copy of the notice) stating: (i) that the Berkeley Way Assessment is delinquent; (ii) the action required to cure the default; (iii) a date, not less than thirty (30) days after the date of the notice, by which the default must be cured; and (iv) that failure to cure the default on or before the date specified in the notice may result in a lawsuit against the Berkeley Way Debtor Lessee. If a delinquent Berkeley Way Assessment and corresponding Additional Charges are not paid in full on or before the date specified in the notice, then the Berkeley Way Creditor Lessee may resort to the remedies set forth in Section 5.7(e) below.

(e) In the event any Berkeley Way Debtor Lessee fails to pay any

12-19-2019

Berkeley Way Assessment, any Berkeley Way Creditor Lessee(s) may, pursuant to Section 7.14 below, commence and maintain an arbitration action, or enforce any other right or remedy available at law or equity, against the Berkeley Way Debtor Lessee obligated to pay such Berkeley Way Assessment. Any ruling rendered in any action shall include the amount of the delinquent Berkeley Way Assessment, Additional Charges, and any other amounts that the ruling body may award.

#### 5.8 Reserve Accounts.

(a) Each Lessee shall establish and contribute to replacement and standard operating reserve accounts in the amount deemed appropriate by the Berkeley Way Joint Maintenance Committee to ensure such Lessee's ability to pay its share of reasonably anticipated Berkeley Way Joint Expenses as may be projected to arise in future years, based on the analysis in the Berkeley Way Annual Joint Expenses Budget. On or about January 1 of each year, each Lessee shall also deliver to the Berkeley Way Joint Maintenance Committee evidence of the amount currently held in the delivering Lessee's collective reserve accounts, including but not limited replacement reserves, standard operating reserves and operating deficit reserves.

(b) A Lessee's failure to deposit funds in its replacement and standard operating reserve account in a manner consistent with 5.8(a) will give rise to a Berkeley Way Reimbursement Assessment even if the other Lessees do not make a contribution to their own reserve account to the extent necessary to compensate for the failing Lessee's failure to contribute to its reserve account.

#### 5.9 Other Reports.

(a) For any year in which the Berkeley Way Assessments payable by a Lessee exceed Fifty Thousand Dollars (\$50,000), a review of the relevant supporting documents and financial statements of such Lessees shall be prepared in accordance with generally accepted accounting principles by a licensee of the California State Board of Accountancy. A Lessee whose relevant supporting documents and financial statements must be reviewed pursuant to this Section 5.9 shall distribute to the other Lessees and the City a copy of such review within one hundred twenty (120) days after the close of each fiscal year for which such a review must be prepared. The dollar amounts in this Section 5.9(a) shall be increased each year by CPI (or by the increase in a similar index if the described index is no longer published).

(b) Unless otherwise agreed to by the Lessees, following completion of the construction of the Project, at least once every five (5) years, the Berkeley Way Joint Maintenance Committee shall perform a physical needs assessment of the Project, and provide a copy to the City. In addition, following completion of the construction of the Project, at least one every five (5) years, the Berkeley Way Joint Maintenance Committee shall cause a study of the reserve requirements of the Property (and the cost of such study shall be a Berkeley Way Joint Expense), and provide a copy to the City. The study shall include the following items:

12-19-2019

(i) Identification of the major components the Maintenance of which is a Berkeley Way Joint Expense and which have, as of the date of the study, a useful life of less than thirty (30) years.

(ii) Identification of the probable remaining useful life of the components identified in Section 5.9(b)(i), as of the date of the study.

(iii) An estimate of the cost of Maintenance of the components identified in Section 5.9(b)(i), both during and at the end of their useful life.

(iv) An estimate of the total annual contribution necessary to defray the cost to Maintain the components identified in Section 5.9(b)(i), both during and at the end of their useful life, after taking into account the amount of reserve funds that are available for the Maintenance of such components as of the date of the study. Rights of Mortgagees.

(a) A Mortgagee shall be protected against Berkeley Way Assessments levied prior to foreclosure (or deed-in-lieu) of the lender's deed of trust. In other words, no Berkeley Way Assessment levied prior to foreclosure (or deed-in-lieu) of a lender's deed of trust shall result in liability for such lender (or another transferee through foreclosure) after the foreclosure.

(b) After coming into possession of a Lessee Parcel through foreclosure or deed in lieu of foreclosure, a Mortgagee (or any party coming into ownership of the Lessee Parcel through the Mortgagee) shall be subject to all Berkeley Way Assessments levied after the foreclosure sale or transfer in lieu of foreclosure other than Berkeley Way Assessments based on obligations accruing, or defaults hereunder arising prior to the date of such foreclosure or transfer in lieu of foreclosure.

## ARTICLE 6 INSURANCE

6.1 Berkeley Way Joint Insurance Policy. The Berkeley Way Joint Maintenance Committee shall select a single insurance carrier to provide the primary property insurance coverage required under this Section 6.1 for the Project (the "Berkeley Way Joint Policy"). Procurement of the Berkeley Way Joint Policy is subject to the terms of the Leases. All Lessees shall be named insureds under the Berkeley Way Joint Policy. The Berkeley Way Joint Maintenance Committee will determine which Lessee is the "first named insured" and which Lessee will provide notices of coverage. The BRIDGE Affordable Lessee shall be the initial entity designated as the "first named insured", and receive all notices under the Berkeley Way Joint Policy; this designation shall remain in place unless a change is agreed in writing amongst all Lessees. The BRIDGE Affordable Lessee shall be the initial entity to provide copies of such notices and evidence of insurance to the other Lessees and the City within five (5) days of receipt. To the extent obtainable, the Berkeley Way Joint Policy shall provide that any change or cancellation of such policy must be made in writing and sent to the Lessees at their respective principal offices and the City at least thirty (30) days before the

12-19-2019

effective date of change or cancellation. Costs associated with the Berkeley Way Joint Policy shall be a Berkeley Way Joint Expense payable by the Lessees according to their Designated Share. If the cost of the Berkeley Way Joint Policy is increased due to the actions or failure to act of one or more, but not all of the Lessees, the Berkeley Way Joint Maintenance Committee may levy a Berkeley Way Special Joint Expenses Assessment pursuant to Section 5.5, to be shared solely among those Lessees responsible for the increase in cost of the Berkeley Way Joint Policy. The Berkeley Way Joint Policy shall insure the Project against loss or damage by the perils insured under the standard ISO Causes of Loss - Special Form or equivalent, including broadening endorsements to protect against the perils of water intrusion and sewer and drain backup. Coverage shall be in amount equal to full replacement cost value of the Project with an "agreed amount" endorsement. Policy shall provide for a full waiver of subrogation by the insurer(s) as to any and all claims against the Lessees and their respective members, officers, directors, partners, agents, employees, and tenants. The replacement cost value of the Project covered by the Berkeley Way Joint Policy shall be redetermined and the amount of coverage adjusted accordingly from time to time as frequently as the Berkeley Way Joint Maintenance Committee shall, in good faith, deem necessary to maintain the coverage amounts, but, in any event, no less frequently than annually.

## 6.2 Other Lessee Insurance.

(a) Lessee Property Insurance. The Lessees shall each, at their sole cost and expense (not as a Berkeley Way Joint Expense) obtain property insurance covering each respective Lessee's personal property, contents, equipment, electronic data processing equipment, tools, fixtures, and the improvements and betterments added to its Lessee Parcel located thereon or used in connection therewith, insuring the Lessee against loss or damage by the perils insured under the standard ISO Causes of Loss - Special Form or equivalent, including broadening endorsements to protect against the perils of water intrusion and sewer and drain backup. Coverage shall be in amount equal to full replacement value with an "agreed amount" endorsement. In addition to the waiver of subrogation required by Section 2.4(c), each such property policy shall provide for a full waiver of subrogation by the insurer as to any and all claims against the Lessees and their respective members, officers, directors, partners, agents, employees, and tenants. Any deductible obligations shall be borne by the policyholder.

(b) Lessee Liability Insurance. Each Lessee shall respectively secure, at their sole cost and expense (not as a Berkeley Way Joint Expense) commercial general liability insurance in an amount not less than \$1,000,000 per occurrence; \$2,000,000 general aggregate; \$2,000,000 products and completed operations aggregate. A commercial umbrella and/or excess liability policy(ies) of not less than \$5,000,000 per occurrence and \$5,000,000 annual aggregate must be maintained in addition to the commercial general liability policy, which is to be scheduled as an underlying policy on the umbrella and/or excess liability policy(ies) along with the automobile liability and employers liability policies required herein. The commercial general liability coverage shall be provided under the Insurance Services Office form

12-19-2019

CG 00 01 or equivalent, and shall provide protection against claims resulting from bodily injury and/or property damage arising out of the respective Lessee's operations and/or use of the Project, and shall include by endorsement if not contained within the coverage form: personal & advertising injury; blanket contractual liability; bodily injury and broad form property damage; fire legal liability; and products and completed operations liability. The Lessee that is the respective policyholder shall name the other Lessees, the City and other Persons specified in the Leases as additional insureds on the general liability and umbrella/excess liability policies and provide a waiver of subrogation endorsement in favor of such additional insureds and their respective members, officers, directors, partners, agents, employees, and tenants. If any Lessee operates at more than one location, or if its policies under this Section cover operations of persons or entities other than the Lessee, the Lessee's policies shall include a "per location" endorsement that provides that the general aggregate and other limits apply separately and specifically to the Project. Any deductible obligations shall be borne by the policyholder.

(c) Lessee Automobile Liability Insurance. Each Lessee shall respectively secure, at their sole cost and expense (not as a Berkeley Way Joint Expense) commercial automobile liability insurance covering all of the Lessee's operations arising out of the use or maintenance of owned, hired and non-owned automobiles, trucks, trailers and semi-trailers, including any machinery or equipment attached thereto. Coverage shall be for limits no less than \$1,000,000 per accident, combined single limit for bodily injury and property damage. The Lessee that is the respective policyholder shall name the other Lessees, the City and other Persons specified in the Leases as additional insureds on this policy and provide a waiver of subrogation endorsement in favor of such additional insureds and their respective members, officers, directors, partners, agents, employees, and tenants. Any deductible obligations shall be borne by the policyholder.

(d) Lessee Workers Compensation & Employers Liability Insurance. Each Lessee shall respectively secure, at their sole cost and expense (not as a Berkeley Way Joint Expense) workers' compensation insurance as required by the statutes of the State in which the Project is located. In addition, Lessee shall secure and maintain employers liability insurance with limits of not less than \$1,000,000 for bodily injury by each accident; \$1,000,000 bodily injury by disease-policy limit; and \$1,000,000 bodily injury by disease each employee. Any deductible obligations shall be borne by the policyholder. Policy shall provide a waiver of subrogation endorsement in favor of each Lessee and their respective members, officers, directors, partners, agents, employees, and tenants, and the City and other Persons specified in the Leases.

(e) Other Insurance. Other than as described in this Declaration, it is the responsibility of each Lessee to secure insurance as the Lessee deems appropriate and as may be required by each Lessee's respective Mortgagees and Lease. Without limiting the foregoing, the Leases may contain specific provisions entitling the City to require higher limits of certain insurance policies under certain circumstances.

### 6.3 General Insurance Provisions.

12-19-2019

(a) Insurer Standards. Except as modified by the Berkeley Way Project Rules, all such policies of insurance shall be obtained from insurance companies authorized or otherwise approved to do business in California, (except for workers compensation and employers liability insurance) and with an A.M. Best rating of Class A:VII or better. In the event A.M. Best should revise its rating system, the Lessees shall (subject to the City's consent) select insurance companies with equivalent financial and policyholder's ratings under the rating system then being used by A.M. Best or in the event A.M. Best discontinues its rating system, insurance companies with equivalent financial and policyholder's ratings under such comparable rating system as the Lessees may select through the Berkeley Way Project Rules.

(b) Notices of Cancellation. To the extent obtainable, all policies shall provide that any change or cancellation of such policy must be made in writing and sent to the Lessees at their respective principal offices and the City at least thirty (30) days before the effective date of the change or cancellation.

(c) Deviation from Insurance Requirements. The Berkeley Way Joint shall be obtained at reasonable premiums in light of the market for such insurance with adequate minimum limits for coverage, endorsements, and deductibles, as determined by the good faith judgment of the Berkeley Way Joint Maintenance Committee, and subject to the City's reasonable consent which consent shall not be unreasonably withheld or delayed (and shall be deemed approved in the City does not approve or disapprove a policy within fifteen (15) business days of request for approval) provided, however, subject to each Lessee's respective Mortgagees and Lease, if the Berkeley Way Joint Maintenance Committee determines that a type or form of insurance required pursuant to this Declaration, is not of any direct benefit to one or more Lessees and the cost of the policy is a Berkeley Way Joint Expense, the Berkeley Way Joint Maintenance Committee shall reduce the proportionate share of the Annual Berkeley Way Joint Expense Budget for the non-benefited Lessee by the amount allocated for that type or form of insurance and shall reallocate that reduced amount among the benefiting Lessees according to their relative Designated Shares; and provided, further, a Lessee may request the Berkeley Way Joint Maintenance Committee to purchase coverage for such Lessee (or tenant(s) of such Lessee) (i) to include coverage for furniture, fixtures, equipment and improvements, and (ii) provide casualty insurance in addition to or excess of that required by Article 6 for such Lessee, its tenants, guests, invitees. All insurance premiums and costs resulting from such request(s) to the Berkeley Way Joint Maintenance Committee shall be charged to and paid by the requesting Lessee as a Berkeley Way Special Joint Expenses Assessment. Notwithstanding anything contained herein, in the event all Lessees agree to obtain one or more types of insurance enumerated in this Article which are in excess of the minimum limits for coverage, endorsements, and deductible set forth herein, upon obtaining prior written consent of the other Lessees, the Berkeley Way Joint Maintenance Committee shall obtain such insurance, and the premiums for such shall be a Berkeley Way Joint Expense.

12-19-2019

ARTICLE 7  
GENERAL PROVISIONS

7.1 Enforcement. Subject to Section 7.14 below, each Lessee, or successor thereto shall have the right to enforce, by any proceeding at law or in equity, all restrictions, conditions, covenants, easements, and reservations now or hereafter imposed by the provisions of this Declaration. Failure of any Lessee to enforce any covenant or restriction in this Declaration shall in no event be deemed a waiver of the right to do so thereafter.

7.2 Invalidity of Any Provision. Should any provision or portion of this Declaration be declared invalid or in conflict with any applicable law, the validity of all other provisions and portions hereof shall remain unaffected and in full force and effect.

7.3 Term; Covenants Run with the Land. The Easements created by and the covenants and restrictions of this Declaration shall run with and bind the Property and each of the Parcels in perpetuity, and shall inure to the benefit of and shall be enforceable by each Lessee, and the Lessee's respective legal representatives, heirs, successors, subtenants and assigns. It is intended that the covenants, easements, agreements, promises and duties of each Lessee set forth in this Declaration shall be construed as covenants and not as conditions, and that, to the fullest extent legally possible, all such covenants shall run with the land and/or constitute equitable servitudes as between the Parcel of the respective covenantor, as the servient tenement, and the Parcel of the respective covenantee, as the dominant tenement.

7.4 Amendments. This Declaration may only be amended in a writing executed by the Lessees. Any amendment must be recorded and shall become effective upon being recorded in the Official Records.

(a) City Approval Rights. Notwithstanding the above, this Declaration shall not be amended in any way or terminated without the prior written approval of the City.

(b) Mortgagee Approval Rights. Notwithstanding the above, this Declaration shall not be amended or terminated without the prior written approval of each Mortgagee holding a Mortgage on a Lessee Parcel.

(c) Limited Partner Approval Rights. Notwithstanding the above, this Declaration shall not be amended or terminated without the prior written approval of the investor limited partners of the BRIDGE Affordable Partnership and the BFHP Hope Center Partnership, if any (the "Limited Partners"), which approval shall not be withheld unreasonably. Failure of any of the Limited Partners to respond in writing within forty-five (45) business days of receipt of a written request for approval of an amendment to or termination of this Declaration, either by approving the amendment or termination or by stating specific reasons for withholding approval, shall be deemed to be approval by any such Limited Partner.

7.5 Damage or Destruction.

12-19-2019

(a) Lessees to Rebuild. Except as set out in Section 7.5(b) below and subject to the rights of Mortgagee and the terms of the Leases, in the event there is any damage or destruction to any portion of the Project as a result of fire or other casualty, the Project shall be repaired and reconstructed in accordance with the Plans and Specifications, as modified by the Lessees, and the provisions for repair and reconstruction as set forth in this Section 7.5. Subject to the rights of Mortgagees, if all such damage or destruction has occurred within the portion of a Project located entirely within one Lessee Parcel, then any cost of repair or reconstruction above the amount of insurance proceeds received for the loss shall be paid by the Lessee of that Lessee Parcel. If the damage or destruction affects more than one Lessee Parcel, then the Berkeley Way Joint Maintenance Committee shall coordinate the repair or reconstruction activities and the cost to repair or reconstruct which are above the amount of insurance proceeds received for the loss shall be divided in an equitable manner (reflecting the amount of repair work needed for each Lessee Parcel) between the Lessee Parcels and paid within a commercially reasonable time as established by the Joint Maintenance Committee.

(b) Lessees Fail to Rebuild. Subject to the terms of the Leases, if any portion of the Project is materially damaged or destroyed by fire or other casualty ("materially damaged or destroyed" is defined for the purpose of this Section 7.5(b) as any damage for which the cost of repair or reconstruction, as determined by a licensed contractor selected by the Lessees, is equal to or greater than Five Hundred Thousand Dollars (\$500,000), as adjusted by a fraction whose numerator is the Consumer Price Index (1982-84=100) for all Urban Consumers published by the United States Department of Labor, Bureau of Labor Statistics for the San Francisco-Oakland-Hayward area, or any successor thereof ("CPI"), last published on the date of damage or destruction, and whose denominator is the CPI last published prior to the Effective Date), and if the Lessees agree not to rebuild, then the BRIDGE Affordable Lessee or such other Lessee selected by the Berkeley Way Joint Maintenance Committee, shall use all reasonable efforts to sell the Project. Subject to the rights of each Lessee's respective Mortgagees in regards to each Lessee's respective share of the proceeds, all insurance proceeds received shall be divided among the Lessees in an equitable manner reflecting the amount of damage sustained by each Lessee's Parcel, and the sales proceeds attributable to the Project shall be distributed to the Lessees in proportion to the fair market value of each Lessee Parcel as determined at the time of sale of the Project. The fair market value of each Lessee Parcel shall be determined by a MAI qualified appraiser jointly selected by the Lessees. If the Lessees cannot agree on an appraiser, then each Lessee shall select an appraiser and the selected appraisers will select another appraiser and this appraiser shall be the appraiser to determine the fair market value of each Lessee Parcel.

(c) Insurance Trustee. Subject to the rights of Mortgagees described above and the City under the Leases (if applicable), all insurance proceeds and other amounts required to be paid in connection with any work of repair or restoration to be undertaken hereunder shall (unless otherwise agreed to by the Lessees) be paid by, or behalf of, the Lessees to an insurance trustee for periodic disbursement to the Lessee of the damaged Lessee Parcel, if the damage is confined to one Lessee Parcel, as the



12-19-2019

work of repair and reconstruction progresses in accordance with prudent construction loan disbursement practices. If the repair work affects more than one Lessee Parcel, such funds shall be periodically disbursed to the BRIDGE Affordable Lessee (or such other Lessee selected by the Berkeley Way Joint Maintenance Committee) for disbursement to the affected Lessees. The insurance trustee shall be a national bank or a nationally recognized title company reasonably acceptable to the Lessees.

7.6 Condemnation. Any total or partial taking of the Project by eminent domain shall be governed by the Leases.

7.7 Limitation of Restrictions on Lessees. The completion of construction of the Project, and the ability of each Lessee to occupy its Lessee Parcel and use such parcel in accordance with this Declaration is essential to the establishment and welfare of the Project as a combined development. In order that such work may be completed and the Project be established as a fully occupied community as rapidly as possible, nothing in this Declaration shall be understood or construed to:

(a) Prevent any Lessee or its contractors or subcontractors from doing on or within any Lessee Parcel whatever is reasonably necessary or advisable in connection with the completion of such work (including construction of, or addition to, any construction that may occur at a date or dates following completion of construction of the remainder of the Project); or

(b) Prevent any Lessee or its representatives from erecting, constructing, or maintaining on any part or parts of the Lessee Parcels such structures as may be reasonable and necessary for the conduct of their business of completing such work and establishing the Project as a combined commercial and residential community; or

(c) Prevent any Lessee from maintaining such sign or signs on any of the Lessee Parcels as may be necessary for the sale, lease, or disposition thereof, to the extent permitted by Section 4.4.

Each Lessee shall make, and shall cause its contractors and subcontractors to make, reasonable efforts to avoid disturbing, while completing any work on the Project, the use and enjoyment of the Lessee Parcels by the other Lessees and their respective Users.

7.8 Lessee's Compliance. Each Lessee shall be liable for performance of, and is bound by and shall comply with, the provisions of this Declaration and the Berkeley Way Project Rules.

7.9 City Manager Authority Limitations. Any amendment to this Declaration, including any amendment which affect or relates to (i) the boundaries of any Parcel; (ii) the grant of any easement, (iii) the permitted use of any Parcel, or (iv) any other material provision of this Declaration, shall require approval by the City's City Council. Subject to the foregoing, the City's City Manager may issue without City Council

12-19-2019

approval any consent or approval which City is entitled to provide under this Declaration, including without limitation: (w) certain Maintenance matters under Section 3.1; (x) certain insurance matters under Article 6; and (v) approval of Berkeley Way Project Rules under Section 7.13.

7.10 Singular and Plural; Gender. The singular and plural number and masculine, feminine and neuter gender shall each include the other where the context requires.

7.11 Notices, Demands and Communications. Except as otherwise provided in this Declaration, formal notices, demands, and communications among the Lessees shall be sufficiently given if, and shall not be deemed given unless, delivered personally, with a delivery receipt; sent by United States Postal Service, certified mail, return receipt requested or sent by reputable overnight delivery service with a receipt showing date of delivery, or by electronic transmission with follow-up by one of the previous three methods, to the address of the City and Lessees as follows:

\_\_\_\_\_  
\_\_\_\_\_  
\_\_\_\_\_

Such written notices, demands and communications may be sent in the same manner to such other addresses as the affected party may from time to time designate by notice to the other parties as provided in this Section. Delivery shall be deemed to have occurred at the time indicated on the receipt as the date of delivery, the date of refusal of delivery, or the date the item was returned as undeliverable.

7.12 No Discrimination. No Lessee shall, either directly or indirectly, forbid or unlawfully restrict the conveyance, encumbrance, leasing, mortgaging, or occupancy of its Lessee Parcel, or a part thereof, to any person on account of race, color, creed, religion, sex, sexual orientation, marital status, ancestry, national origin, familial status, or handicap.

7.13 Rights of Mortgagees. The rights of a Lessee under this Declaration shall be subject to the rights of a Mortgagee to such Lessee. No breach or violation of the Declaration shall defeat or render invalid the lien of any Mortgage upon a Lessee Parcel made in good faith and for value.

7.14 Berkeley Way Project Rules. Subject to the City's reasonable consent if requested by the City, the Lessees may develop mutually acceptable rules (the "Berkeley Way Project Rules") to address matters pertaining to the mutually convenient use and operation of the Project in addition to the matters set forth in this Declaration. If the Lessees cannot develop mutually acceptable Berkeley Way Project Rules then the Lessees shall submit the issues in dispute to mediation in accordance with Section 7.14. The Berkeley Way Project Rules shall be in writing and copies shall be provided to all Lessees, and all amendments to such Berkeley Way Project Rules must be in writing and approved by all Lessees.

12-19-2019

7.15 Dispute Resolution. In the event that the Lessees are unable to agree on any aspect of the requirements of this Declaration, or if there is a dispute as to a Lessee's performance, then any Lessee shall be entitled to mediation in accordance with the following procedures:

(a) Formal Mediation of Disputes. Any Lessee may request the dispute be mediated through a mediation before a retired judge or justice from the Judicial Arbitration & Mediation Services, Inc., or its successor-in-interest, or such other alternative dispute resolution service reasonably acceptable to the Lessees, (in each event such entity is referred to herein as "JAMS") pursuant to the mediation process described in this Section 7.14.

(b) Initiating Mediation. The Lessee desiring the mediation (the "Requesting Party") shall send written notice to the other party (the "Receiving Party") in accordance with Section 7.10 requesting mediation. The Receiving Party shall have thirty (30) days from receipt of the written request to submit the matter to mediation. Within ten (10) days after receipt of the Receiving Party's agreement to submit the matter to mediation, the Requesting Party shall send written demand to the Dispute Resolution Administrator of JAMS (the "Administrator") at the office of JAMS in or closest to the City with the names, addresses, telephone numbers and e-mail addresses of all parties to this Declaration and a brief synopsis of the claim, controversy, difference, or disputed matters and a proposed solution to the problem, with copies sent to the Receiving Party.

(c) Selection of Mediator. As soon as practicable after the demand is served upon JAMS, the Administrator will contact the Lessees to select a mutually agreeable mediator. If the Lessees have no particular mediator in mind or cannot agree on a mediator, the Administrator will submit a list of mediators, and their resumes, numbering at least one more than there are parties. Each Lessee may then strike one name and the Administrator will designate the mediator from the list of remaining names.

(d) Hearings-Scheduling/Parties Present. After the mediator has been selected, the Lessees shall promptly agree upon a date and time for the initial conference with the mediator, but no later than thirty (30) days after the date the mediator was selected. The Lessees understand and agree that, besides counsel, each Lessee may bring only such additional persons as are needed to respond to questions, contribute information and participate in the negotiations. The number of additional parties may be agreed upon in advance with the assistance and advice of the mediator.

(e) Position Papers. No later than seven (7) days before the first scheduled mediation session, each Lessee shall deliver a concise written summary of its position, together with any appropriate documents, views and a proposed solution to the matters in controversy to the mediator and also serve a copy on all other parties.

(f) Participation by Mediator. Once familiar with the case, the mediator will give recommendations on terms of possible settlement conditions to be imposed

12-19-2019

upon the Lessees (if appropriate). The mediator's opinion shall be based on the material and information then available to the Lessees, excluding any information given to the mediator in confidence during a separate caucus. The opinions and recommendations of the mediator are not binding on the Lessees.

(g) Confidentiality of Proceedings. The mediation process is to be considered settlement negotiation for the purpose of all state and federal rules protecting disclosures made during such conferences from the later discovery or use in evidence. The Lessees agree that the provisions of California Evidence Code Section 1152.5 shall apply to any mediation conducted hereunder. The entire procedure is confidential, and no stenographic or other record shall be made except to memorialize a settlement record. All conduct, statements, promises, offers, views and opinions, oral or written, made during the mediation by any party or a party's agent, employee, or attorney are confidential and, where appropriate, are to be considered work product and privileged. Such conduct, statements, promises, offers, views and opinions shall not be subject to discovery or admissible for any purpose, including impeachment, in any litigation or other proceeding involving the parties; provided, however, that evidence otherwise subject to discovery or admissible is not excluded from discovery or admission in evidence simply as a result of it having been used in connection with this settlement process.

(h) Fees and Costs. The fees and costs of the mediation shall conform to the then current fee schedule at JAMS and, in the absence of a written agreement to the contrary, shall be shared equally by the parties in the mediation, but any other costs incurred in connection with the dispute resolution shall be borne by the Lessee incurring such costs.

(i) Termination of Mediation Process. The mediation process shall continue until the matter is resolved, or the mediator makes a good faith finding that all settlement possibilities have been exhausted and there is no possibility of resolution through mediation. To the extent possible, mediation shall be conducted from 9:00 a.m. to 5:00 p.m., with a one (1)-hour break, on consecutive days. In no event shall a Lessee be required to mediate for more than five (5) days.

(j) Condition Precedent to Litigation. The Lessees agree and acknowledge that any dispute arising from this Declaration brought before a court of competent jurisdiction shall first be subject to the mediation process, as set forth in this Section 7.14, as a condition precedent. Any such mediation shall be nonbinding except to the extent otherwise expressly provided herein.

Notwithstanding the foregoing, nothing in this Section 7.14 shall prohibit a Lessee from pursuing the rights set forth in Section 7.17.

**7.16 Default Shall not Permit Termination of Declaration**. No default under this Declaration shall entitle any Lessee to terminate, cancel or otherwise rescind this Declaration; provided, however, that this limitation shall not affect any other rights or remedies that the Lessees may have by reason of any default under this Declaration.

12-19-2019

7.17 Violation a Nuisance. The result of every act or omission whereby any provision of this Declaration is violated in whole or in part is hereby declared to be a nuisance, and every remedy allowed by law or equity against a Lessee for nuisance, either public or private, shall be available to and may be exercised by the other Lessee.

7.18 Right to Enjoin/Specific Performance. In the event of any violation or threatened violation of any of the provisions of this Declaration by a Lessee or User, the other Lessee shall have the right to apply to a court of competent jurisdiction for an injunction against such violation or threatened violation, or for specific performance of the subject provision, but nothing in this Section shall be deemed to affect whether or not injunctive relief or specific performance is available on account of such violation or threatened violation. The dispute resolution process set forth in Section 7.14 shall not apply to this Section 7.17.

7.19 Title of Parts and Sections. Any titles of the sections or subsections of this Declaration are inserted for convenience of reference only and shall be disregarded in interpreting any part of the Declaration's provisions.

7.20 Applicable Law. This Declaration shall be interpreted under and pursuant to the laws of the State of California.

7.21 Legal Actions. Without limiting Section 7.14 above, if any legal action is commenced to interpret or to enforce the terms of this Declaration or to collect damages as a result of any breach of this Declaration, then the Lessee prevailing in any such action shall be entitled to recover against the Lessee not prevailing all reasonable attorneys' fees and costs incurred in such action (and any subsequent action or proceeding to enforce any judgment entered pursuant to an action on this Declaration).

7.22 No Partnership; Joint Venture or Principal-Agent Relationship. Neither anything in this Declaration nor any acts of the Lessees shall be deemed by any Lessee, or by any third Person, to create the relationship of principal and agent, or of partnership, or of joint venture, or of any association between the Lessees.

7.23 Declaration for Exclusive Benefit of the Lessees. Except for provisions expressly stated to be for the benefit of a Mortgagee and City, the provisions of this Declaration are for the exclusive benefit of the Lessees and successors and assigns, and not for the benefit of, nor give rise to any claim or cause of action by, any third Person.

7.24 Estoppel Certificate. Within ten (10) days after a written request of a Lessee or the City, the other Lessee(s) shall, issue to such requesting Lessee, or to any Mortgagee, or to any prospective purchaser or prospective Mortgagee specified by such requesting Lessee, or to any other Person reasonably designated by the requesting Lessee or the City (if requested by the City), an estoppel certificate stating: (a) whether the Lessee to whom the request has been directed knows of any default under this Declaration and, if there are known defaults, specifying the nature thereof; (b) whether to such Lessee's knowledge this Declaration has been modified or amended in any way

12-19-2019

(or if it has, then stating the nature thereof); and (c) that to the Lessee's knowledge this Declaration as of that date is in full force and effect or, if not, so stating.

7.25 No Dedication. Nothing contained in this Declaration shall be deemed to create or result in a dedication of any portion of the Lessee Parcels for public use or to create any rights in the general public.

7.26 Time of Essence. Time is of the essence with respect to the performance of each of the covenants and agreements contained in this Declaration.

7.27 Multiple Originals; Counterparts. This Declaration may be executed in multiple originals, each of which is deemed to be an original, and may be signed in counterparts.

7.28 Further Assurances. In addition to the actions recited herein and contemplated to be performed, executed, and/or delivered hereunder, each Lessee will perform, execute and/or deliver or cause to be performed, executed and/or delivered any and all such further acts, instruments, deeds and assurances as may be reasonably required to provide for the use and operation of the Property and the Lessee Parcels in an efficient and coordinated manner as contemplated hereby.

7.29 City As Fee Owner. Unless and until the City is a Lessee as defined in this Declaration, it will have no responsibilities or liabilities under this Declaration.

7.30 Severability. If any term of this Declaration is held in a final disposition by a court of competent jurisdiction to be invalid, then the remaining terms shall continue in full force unless the rights and obligations of the Lessees have been materially altered by such holding of invalidity.

12-19-2019

The undersigned has executed this Declaration as of the Effective Date.

CITY OF BERKELEY

By: \_\_\_\_\_

Its: \_\_\_\_\_

BFHP HOPE CENTER LP,  
a California limited partnership

By: Hope Center Housing LLC,  
a California limited liability company,  
its managing general partner

By: BRIDGE Housing Corporation,  
a California nonprofit public benefit corporation,  
its co-member

By: \_\_\_\_\_  
Smitha Seshadri  
Executive Vice President

By: Berkeley Food and Housing Project,  
a California nonprofit religious corporation,  
its co-member

By: \_\_\_\_\_  
Callenne Egan  
Executive Director

[Signatures continue on following page]

DRAFT

12-19-2019

BRIDGE Berkeley Way LP,  
a California limited partnership

By: BRIDGE Berkeley Way LLC,  
a California limited liability company,  
its Managing General Partner

By: BRIDGE Housing Corporation,  
a California nonprofit public benefit corporation,  
its sole member and manager

By: \_\_\_\_\_  
Smitha Seshadri,  
Executive Vice President



12-19-2019

A notary public or other officer completing this certificate verifies only the identity of the individual who signed the document to which this certificate is attached, and not the truthfulness, accuracy, or validity of

STATE OF CALIFORNIA )  
 )  
COUNTY OF \_\_\_\_\_ )

On \_\_\_\_\_, before me, \_\_\_\_\_, Notary Public, personally appeared \_\_\_\_\_, who proved to me on the basis of satisfactory evidence to be the person(s) whose name(s) is/are subscribed to the within instrument and acknowledged to me that he/she/they executed the same in his/her/their authorized capacity(ies), and that by his/her/their signature(s) on the instrument the person(s), or the entity upon behalf of which the person(s) acted, executed the instrument.

I certify UNDER PENALTY OF PERJURY under the laws of the State of California that the foregoing paragraph is true and correct.

WITNESS my hand and official seal.

\_\_\_\_\_  
Name: \_\_\_\_\_  
Notary Public

DRAFT

12-19-2019

EXHIBIT A  
(Property Description)

DRAFT

12-19-2019

EXHIBIT B  
(Parcel Map)

DRAFT

12-19-2019

RECORDING REQUESTED BY:  
AND WHEN RECORDED MAIL TO:

Goldfarb & Lipman LLP  
1300 Clay Street, Eleventh Floor  
Oakland, CA 94612  
Attn: Heather Gould

---

---

**DECLARATION OF AND AGREEMENT REGARDING COVENANTS, CONDITIONS  
AND RESTRICTIONS  
PROVIDING FOR RECIPROCAL EASEMENTS, JOINT USE AND  
MAINTENANCE FOR THE BERKELEY WAY PROJECT**

TABLE OF CONTENTS

DRAFT  
Page

ARTICLE 1 DEFINITIONS ..... 2

    1.1 Definitions..... 2

    1.2 Exhibits..... 8

ARTICLE 2 DIVISION OF PROPERTY, GRANT OF EASEMENTS ..... 8

    2.1 General Description of Property..... 8

    2.2 No Separate Conveyance of Easements..... 8

    2.3 Grant of Easements..... 8

    2.4 Hold Harmless..... 11

ARTICLE 3 MAINTENANCE AND ALTERATIONS..... 12

    3.1 Maintenance of the Lessee Parcels..... 12

    3.2 Specific Maintenance..... 13

    3.3 Prohibited Alterations; Alterations to Berkeley Way Project-  
    Serving Components..... 14

ARTICLE 4 USE RESTRICTIONS ..... 14

    4.1 BRIDGE Affordable Parcel..... 14

    4.2 BFHP Hope Center Parcels..... 15

    4.3 Compliance with Laws; No Nuisances..... 15

    4.4 Signs..... 15

    4.5 Telecommunications Equipment and Roof Mounted  
    Equipment..... 15

    4.6 Garbage and Refuse Disposal..... 15

ARTICLE 5 JOINT MAINTENANCE EXPENSES, ASSESSMENTS AND  
RESERVES ..... 16

    5.1 Berkeley Way Joint Maintenance Committee..... 16

    5.2 Coordination of Berkeley Way Joint Maintenance and Repair  
    after Damage or Destruction..... 17

    5.3 Berkeley Way Annual Joint Expenses Budget..... 17

    5.4 Berkeley Way Joint Expenses Assessments..... 18

    5.5 Berkeley Way Special Joint Expenses Assessments..... 19

    5.6 Berkeley Way Reimbursement Assessments..... 19

    5.7 Payment and Enforcement of Assessments..... 20

    5.8 Reserve Accounts..... 21

    5.9 Other Reports..... 21

    5.10 Rights of Mortgagees..... 22

ARTICLE 6 INSURANCE ..... 22

TABLE OF CONTENTS  
(continued)

DRAFT  
Page

6.1 Berkeley Way Joint Insurance Policy..... 22

ARTICLE 7 GENERAL PROVISIONS..... 26

7.1 Enforcement..... 26

7.2 Invalidity of Any Provision..... 26

7.3 Term; Covenants Run with the Land..... 26

7.4 Amendments..... 26

7.5 Damage or Destruction..... 26

7.6 Condemnation..... 28

7.7 Limitation of Restrictions on Lessees..... 28

7.8 Lessee's Compliance..... 28

7.9 City Manager Authority Limitations..... 28

7.10 Singular and Plural; Gender..... 29

7.11 Notices, Demands and Communications..... 29

7.12 No Discrimination..... 29

7.13 Rights of Mortgagees..... 29

7.14 Berkeley Way Project Rules..... 29

7.15 Dispute Resolution..... 30

7.16 Default Shall not Permit Termination of Declaration..... 31

7.17 Violation a Nuisance..... 32

7.18 Right to Enjoin/Specific Performance..... 32

7.19 Title of Parts and Sections..... 32

7.20 Applicable Law..... 32

7.21 Legal Actions..... 32

7.22 No Partnership; Joint Venture or Principal-Agent  
Relationship..... 32

7.23 Declaration for Exclusive Benefit of the Lessees..... 32

7.24 Estoppel Certificate..... 32

7.25 No Dedication..... 33

7.26 Time of Essence..... 33

7.27 Multiple Originals; Counterparts..... 33

7.28 Further Assurances..... 33

7.29 City As Fee Owner..... 33

7.30 Severability..... 33

EXHIBIT A..... PROPERTY DESCRIPTION

EXHIBIT B..... PARCEL MAP

12-19-2019

**DECLARATION OF AND AGREEMENT REGARDING COVENANTS, CONDITIONS AND RESTRICTIONS PROVIDING FOR RECIPROCAL EASEMENTS, JOINT USE AND MAINTENANCE FOR THE BFHP HOPE CENTER**

THIS DECLARATION OF AND AGREEMENT REGARDING COVENANTS, CONDITIONS AND RESTRICTIONS PROVIDING FOR RECIPROCAL EASEMENTS, JOINT USE AND MAINTENANCE FOR THE BFHP HOPE CENTER (the "Hope Center Declaration") is made as of \_\_\_\_\_, 20\_\_\_\_ (the "Effective Date"), by the City of Berkeley (the "City") as owner of the fee interest in the Hope Center Property described herein, and BFHP Hope Center LP (the "BFHP Hope Center Partnership"), as lessee of said Hope Center Property (City and said lessee being referred to herein collectively as the "Hope Center Declarants"), with reference to the following facts:

RECITALS

A. These Recitals refer to and utilize certain capitalized terms, the definitions of which are identified in Article 1 below.

B. The City owns certain real property located at 2012 Berkeley Way in Berkeley, California, as more particularly described in Exhibit A attached hereto and incorporated herein (the "Hope Center Property") The Hope Center Property in this Hope Center Declaration is referred to as the BFHP Hope Center Parcels under the Berkley Way REA. Hope Center Declarants have caused the subdivision of the Hope Center Property pursuant to the Map. The Map and this Hope Center Declaration collectively delineate the Permanent Supportive Housing Parcel and the Temporary Housing Parcel. The Permanent Supportive Housing Development is located on the Permanent Supportive Housing Parcel. The Temporary Housing Development is located on the Temporary Housing Parcel.

C. City has no current intention of developing the Permanent Supportive Housing Development, the Temporary Housing Development or the Hope Center Parcels comprising the Hope Center Property. Concurrently with the making of this Hope Center Declaration, the City has leased both the Permanent Supportive Housing Development and the Temporary Housing Development to the BFHP Hope Center Partnership for the purpose of developing the Permanent Supportive Housing Development and the Temporary Housing Development, which collectively are the BFHP Hope Center Development. BFHP Hope Center Partnership is intended to be the long term lessee and operator of the Permanent Supportive Housing Development portion of the BFHP Hope Center and BFHP Hope Center LLC is intended to be the long term lessee and operator of the Temporary Housing Development portion of the BFHP Hope Center.

D. Pursuant to this Hope Center Declaration, the Hope Center Declarants are (i) setting forth certain rights and responsibilities pertaining to the easements affecting the Hope Center Property granted herein and by virtue of the Map, and (ii) providing for the management, maintenance and operation of the Hope Center Parcels, and certain

12-19-2019

joint uses thereof. Certain other matters are identified in the Berkeley Way REA executed and recorded concurrently herewith.

E. The Hope Center Project is not a common interest development as defined by Civil Code Section 4100. The Hope Center Project and the Hope Center Lessees are therefore not subject to the Davis-Stirling Common Interest Development Act (codified at Civil Code Sections 4000 et seq.).

WITH REFERENCE TO THE FACTS RECITED ABOVE, the Hope Center Declarants declare and agree as follows:

ARTICLE 1  
DEFINITIONS

1.1 Definitions. Capitalized terms not otherwise defined in this Hope Center Declaration shall have the meaning set forth below:

- (a) "Berkeley Way Annual Joint Expenses Budget" is defined in Section 5.3 of the Berkeley Way REA.
- (b) "Berkeley Way Joint Maintenance Committee" means the committee responsible for the coordination of the Maintenance under the Berkeley Way REA, as set forth in more detail in Section 5.1 of the Berkeley Way REA.
- (c) "Berkeley Way Project-Serving Components" has the meaning set forth in Section 1.1 of the Berkeley Way REA.
- (d) "Berkeley Way Property" means the Hope Center Property and the BRIDGE Affordable Parcel.
- (e) "Berkeley Way REA" means the Declaration of and Agreement Regarding Covenants, Conditions and Restrictions Providing for Reciprocal Easements, Joint Use and Maintenance for the Berkeley Way between the City, BRIDGE Affordable Partnership and the BFHP Hope Center Partnership dated \_\_\_\_\_ and recorded in the Official Records substantially concurrently herewith.
- (f) "BFHP Hope Center Development" means the Permanent Supportive Housing Development and Temporary Housing Development located on the Hope Center Property.
- (g) "BFHP Hope Center LLC" means BFHP Hope Center LLC, a California limited liability company.
- (h) "BFHP Hope Center Partnership" means BFHP Hope Center Partnership, a California limited partnership.
- (i) "BRIDGE Affordable Parcel" means the portion of the Berkeley



12-19-2019

Way Property designated as "Parcel C" on the Map.

(j) "BRIDGE Affordable Partnership" means BRIDGE Berkeley Way LP, a California limited partnership.

(k) "City" has the meaning set forth in the preamble of this Hope Center Declaration.

(l) "Hope Center Annual Joint Expenses Budget" has the meaning given in Section 5.5.

(m) "Hope Center Assessments" means Hope Center Joint Expenses Assessments, Hope Center Reimbursement Assessments and/or Hope Center Special Joint Expenses Assessments.

(n) "Hope Center Creditor Lessee" means a Hope Center Lessee to whom a Hope Center Assessment is owed by another Hope Center Lessee or a Hope Center Lessee seeking to ensure payments required under Section 5.10 are made to a reserve account.

(o) "Hope Center Debtor Lessee" means a Hope Center Lessee who owes either a Hope Center Assessment to another Hope Center Lessee or a payment required under Section 5.10 to be made to its reserve account which Hope Center Assessment or payment has not been made when due.

(p) "Hope Center Declarants" has the meaning set forth in the preamble of this Hope Center Declaration.

(q) "Hope Center Declaration" means this Declaration of and Agreement Regarding Covenants, Conditions and Restrictions Providing Reciprocal Easements, Joint Use and Maintenance for the BFHP Hope Center, and all amendments, modifications and supplements executed in accordance herewith.

(r) "Hope Center Designated Share" means the following percentages for Maintenance of Hope Center Project-Serving Components (which were calculated based upon the gross square footage of the Hope Center Parcels):

Permanent Supportive Housing Lessee	75%
Temporary Housing Lessee	25%

Notwithstanding the forgoing, the Hope Center Designated Share paid by a Hope Center Lessee may be modified by the Hope Center Lessees (with the consent of the City) for costs associated with Hope Center Project-Serving Components which benefit more than one but not all of the Hope Center Lessees or which are later determined to provide disproportionate benefit to one or more Hope Center Lessee. Any such modification shall cause costs to be allocated in an equitable manner solely among the benefited Hope Center Lessees

12-19-2019

(s) "Hope Center Easements" means the easements granted through this Hope Center Declaration. The Hope Center Easements will be described by function or location rather than by precise measurement on the Map or the Plans and Specifications.

(t) "Hope Center Improvements" mean the BFHP Hope Center Development, and all other improvements and fixtures that may be built on and/or installed in any of the Hope Center Lessee Parcels from time to time, including landscaping.

(u) "Hope Center Joint Expenses" means, collectively, (i) all costs and expenses of Maintenance of Hope Center Project-Serving Components, and (ii) any other expenses provided for in a Hope Center Annual Joint Expenses Budget or that this Hope Center Declaration provides to be paid by a Hope Center Lessee according to its Hope Center Designated Share.

(v) "Hope Center Joint Expenses Assessment" has the meaning given in Section 5.6.

(w) "Hope Center Joint Maintenance Committee" means the committee responsible for the coordination of the Maintenance of Hope Center Project-Serving Components and other duties as set forth in more detail in Section 5.2 below.

(x) "Hope Center Lessee" means (i) the Permanent Supportive Housing Lessee or (ii) the Temporary Housing Lessee (each being referred to herein as a "Hope Center Lessee" and collectively referred to as the "Hope Center Lessees").

(y) "Hope Center Lessee Parcel" means any of the Permanent Supportive Housing Parcel, or the Temporary Housing Parcel (each being referred to herein as a "Hope Center Lessee Parcel" and collectively referred to as "Hope Center Lessee Parcels").

(z) "Hope Center Project" means, collectively, the Hope Center Parcels, and all Hope Center Improvements constructed on such Hope Center Parcels.

(aa) "Hope Center Project Rules" means the rules that may be adopted by the Hope Center Lessees from time to time, pursuant to Section 7.11 to address certain issues not fully addressed in this Hope Center Declaration.

(bb) "Hope Center Project-Serving Components" means (i) components of the Hope Center Improvements that service both of the Hope Center Lessee Parcels such as the structural walls, elevators, stairways, and (ii) components of any system in the Hope Center Improvements that services both Hope Center Parcels. Hope Center Project-Serving Components include the MPOE room, electric room, gas meter, trash room, bed bug room, elevators, sewer ejector pump, sewer lateral, domestic water connection, and other utility installations contained within and immediately surrounded by or attached to any structure or space which is part of the Hope Center Project and passes through both Hope Center Lessee Parcels (as required to provide power, light,

12-19-2019

telephone, cable television, gas, water, sanitary sewerage, storm sewerage, and drainage services); other usual appurtenances; and any other Hope Center Project element which is not located solely within one Hope Center Parcel and which the Hope Center Lessees determine to be a Hope Center Project-Serving Component, except utility equipment which is part of a discrete and complete system servicing only one Hope Center Lessee Parcel. In addition, Berkeley Way Project-Serving Components are not Hope Center Project-Serving Components under this Hope Center Declaration.

(cc) "Hope Center Property" means that certain real property described in Exhibit A. The Hope Center Property consists of the Permanent Supportive Housing Parcel and the Temporary Housing Parcel portions of the Berkeley Way Property designated as "Parcel A" and "Parcel B", respectively, on the Map.

(dd) "Hope Center Parcels" means the Hope Center Lessee Parcels.

(ee) "Hope Center Reimbursement Assessment" has the meaning given in Section 5.8(b).

(ff) "Hope Center Reimbursement Expense" has the meaning given in Section 5.8(a).

(gg) "Hope Center Special Joint Expenses Assessment" has the meaning given in Section 5.7.

(hh) "Leases" means the Permanent Supportive Housing Ground Lease and Temporary Housing Ground Lease, as either may be amended from time to time.

(ii) "Maintain" means undertake Maintenance.

(jj) "Maintenance" means the maintaining (including cleaning and routine, day to day, janitorial services), repairing and replacing of any improvement on a Hope Center Parcel (including a Hope Center Project-Serving Component, or related to a Hope Center Easement).

(kk) "Map" means that certain parcel map entitled Parcel Map No. 11051 filed in the Official Records on \_\_\_\_\_, 2020 as file number \_\_\_\_\_, subdividing the Berkeley Way Property into the Hope Center Parcels, and BRIDGE Affordable Parcel a copy of which is attached to this Hope Center Declaration as Exhibit B and incorporated herein.

(ll) "Mortgage" means a recorded mortgage or deed of trust encumbering a Hope Center Parcel, which is given as security by a Hope Center Lessee for the payment of money or performance of an obligation.

(mm) "Mortgagee" means any Person, bank, savings and loan association, insurance company, or other financial institution that is either a mortgagee under a mortgage or the beneficiary under a deed of trust and any holder, governmental guarantor, or insurer of any such mortgage or deed of trust.

12-19-2019

(nn) "Official Records" means the Official Records of the County of Alameda, State of California.

(oo) "Permanent Supportive Housing Development" means approximately fifty-three (53) units of affordable supportive housing units located on the Permanent Supportive Housing Parcel.

(pp) "Permanent Supportive Housing Ground Lease" means that certain ground lease entered into by and between the City and the BFHP Hope Center Partnership for the Permanent Supportive Housing Parcel, as amended from time to time.

(qq) "Permanent Supportive Housing Lessee" means (i) the long term tenant or lessee of the Permanent Supportive Housing Parcel pursuant to the Permanent Supportive Housing Ground Lease, or a replacement thereof, as well as the successors or assigns of any such lessee, or (ii) if the Permanent Supportive Housing Ground Lease expires or is terminated and is not replaced by a long term lease, the fee owner, from time to time, of the Permanent Supportive Housing Parcel. The BFHP Hope Center Partnership is the initial Permanent Supportive Housing Lessee.

(rr) "Permanent Supportive Housing Parcel" means the portion of the Hope Center Property designated as "Parcel A" on the Map.

(ss) "Permanent Supportive Housing Hope Center Project-Serving Components" means a Hope Center Project-Serving Components located on the Permanent Supportive Housing Parcel.

(tt) "Person" shall have the meaning set forth in the Berkeley Way REA.

(uu) "Plans and Specifications" shall have the meaning set forth in the Berkeley Way REA.

(vv) "Temporary Housing Development" means approximately forty-four (44) beds of temporary housing, a services center and administrative office space.

(ww) "Temporary Housing Parcel" means the portion of the Hope Center Property designated as "Parcel B" on the Map.

(xx) "Temporary Housing Lessee" means (i) the long term lessee of the Temporary Housing Parcel pursuant to Temporary Housing Ground Lease, or a replacement thereof, as well as the successors or assigns of any such lessee, or (ii) if the Temporary Housing Ground Lease expires or is terminated and is not replaced by a long term lease, the fee owner, from time to time, of the Temporary Housing Parcel. BFHP Hope Center Partnership is the initial Temporary Housing Lessee, but the parties anticipate that BFHP Hope Center LLC will be the Temporary Housing Lessee following completion of construction and issuance of the IRS 8609 (Low Income Housing Tax Credit Allocation and Certification) for the Permanent Supportive Housing Development.

12-19-2019

(yy) "Temporary Housing Ground Lease" means the ground lease to be entered into by and between the City and the Temporary Housing Lessee for all or part of the Temporary Housing Parcel, as amended from time to time.

(zz) "Temporary Housing Hope Center Project-Serving Component" means a Hope Center Project-Serving Component located on the Temporary Housing Parcel.

(aaa) "Users" is defined in the Berkeley Way REA.

1.2 Exhibits. The following exhibits are attached to and incorporated into this Hope Center Declaration:

- Exhibit A      Legal Description of the Hope Center Property
- Exhibit B      Parcel Map

ARTICLE 2

DIVISION OF HOPE CENTER PROPERTY, GRANT OF EASEMENTS

2.1 General Description of Hope Center Property.

(a) General Boundaries. The Permanent Supportive Housing Parcel and the Temporary Housing Parcel have the boundaries shown on the Map.

(b) Hope Center Property. The Hope Center Property will contain the BFHP Hope Center Development to be developed by the BFHP Partnership. The Hope Center Property is comprised of the Permanent Supportive Housing Parcel and the Temporary Housing Parcel.

2.2 No Separate Conveyance of Hope Center Easements. The ownership of each of the Hope Center Parcels includes the benefit of, and is encumbered by and is subject, to the Hope Center Easements, as applicable. The Hope Center Easements are (i) established through this Hope Center Declaration and are to be conveyed, as applicable, with each of the Hope Center Lessee Parcels (ii) cannot be modified, terminated or relocated (except as set forth in this Hope Center Declaration), and (iii) may not be separated or separately conveyed. The benefit and burden of each Hope Center Easement, as applicable, shall be deemed to be conveyed with its respective Hope Center Parcel, even though the description in the instrument of conveyance may refer only to the fee or leasehold title to such Hope Center Parcel. The Hope Center Easements are essential and necessary for the development and ongoing operation of the Hope Center Improvements.

2.3 Grant of Hope Center Easements. Through this Hope Center Declaration, the Hope Center Declarants hereby grant and establish the following easements affecting the Hope Center Project and the Hope Center Parcels.

(a) Easement for Temporary Housing Access; Use; Ingress and Egress.

12-19-2019

(i) Entry Easement. The Temporary Housing Lessee is hereby granted, and the Temporary Housing Parcel shall have the benefit of and the Permanent Supportive Housing Parcel shall be burdened by, a non-exclusive easement in, on, under, over and across the entryway of the Permanent Supportive Housing Parcel for access to the Temporary Housing Development from Berkeley Way (the "Entry Easement").

(ii) Elevator Easement. The Temporary Housing Lessee is hereby granted, and the Temporary Housing Parcel shall have the benefit of and the Permanent Supportive Housing Parcel shall be burdened by, a non-exclusive easement across eastern portion of the first floor of the Permanent Supportive Housing Parcel (the "Elevator Easement") for access to the elevator in the Permanent Supportive Housing Parcel and use of such elevator on and between the first floor and the second floor of the Hope Center Project.

(iii) Stairway Easement. The Temporary Housing Lessee is hereby granted, and the Temporary Housing Parcel shall have the benefit of and the Permanent Supportive Housing Parcel shall be burdened by, non-exclusive easement across the Permanent Supportive Housing Parcel stairways for emergency exit purposes (the "Stairway Easement").

(iv) Emergency Exit Easement. The Temporary Housing Lessee is hereby granted, and the Temporary Housing Parcel shall have the benefit of and the Permanent Supportive Housing Parcel shall be burdened by, a non-exclusive emergency exit easement across the Permanent Supportive Housing Parcel to allow access to the exterior courtyard and Southern Egress Easement (as defined in the Berkeley Way REA) for emergency exit purposes (the "Emergency Exit Easement").

(v) Access to and Use of Trash Room Easement. The Temporary Housing Lessee is hereby granted, and the Temporary Housing Parcel shall have the benefit of and the Permanent Supportive Housing Parcel shall be burdened by, a non-exclusive easement to access and use the trash room located on the ground floor of the Permanent Supportive Housing Parcel (the "Trash Room Easement").

(vi) Access to and Use of Mail Box Easement. The Temporary Housing Lessee is hereby granted, and the Temporary Housing Parcel shall have the benefit of and the Permanent Supportive Housing Parcel shall be burdened by, a non-exclusive easement to access and use the mailbox area located on the first floor of the Permanent Supportive Housing Parcel for Temporary Housing Lessee employee and management agent mail (the "Mail Box Easement").

The exact location of the Elevator Easement, Trash Room Easement and Mailbox Easement shall be reasonably determined by the Permanent Supportive Housing Lessee.

(b) Easement for Permanent Supportive Housing Access; Use; Ingress and Egress.

12-19-2019

(i) PSH Access Easement. The Permanent Supportive Housing Lessee is hereby granted, and the Permanent Supportive Housing Parcel shall have the benefit of and the Temporary Housing Parcel shall be burdened by, a non-exclusive easement in, on, under, over and across the entry way of the Temporary Housing Parcel for access to the Permanent Supportive Housing Parcel ("PSH Access Easement").

(ii) Courtyard Easement. The Permanent Supportive Housing Lessee is hereby granted, and the Permanent Supportive Housing Parcel shall have the benefit of and the Temporary Housing Parcel shall be burdened by, a non-exclusive easement in, on, under, over and across the Temporary Housing Parcel to the courtyard area of the Permanent Supportive Housing Parcel.

(iii) Bed Bug Room Easement. The Permanent Supportive Housing Lessee is hereby granted, and the Permanent Supportive Housing Lessee shall have the benefit of and the Temporary Housing Parcel shall be burdened by, a non-exclusive easement to access and use the bed bug room located on the first floor of the Temporary Housing Parcel (the "Bed Bug Room Easement").

The exact location of the Bed Bug Room Easement and Courtyard Easement shall be reasonably determined by the Temporary Housing Lessee.

#### 2.4 Hold Harmless.

(a) Each Hope Center Lessee (an "Indemnifying Lessee") shall indemnify, defend, and hold each of the other Hope Center Lessees (the "Indemnified Lessees") harmless from all liability, damage, cost, or expense incurred by any of the Indemnified Lessees arising out of the utilization by the Indemnifying Lessee or any of its Users of any of the Hope Center Easements within any such Indemnified Lessee's Hope Center Lessee Parcel, or arising out of any violation by such Indemnifying Lessee of its obligations under this Hope Center Declaration, except to the extent that any such liability, damage, cost or expense results from the negligence or willful misconduct of the Indemnified Lessee.

(b) Each Hope Center Lessee shall indemnify, defend, and hold each of the other Hope Center Lessees harmless from all liability, damage, cost, or expense incurred by any such other Hope Center Lessee arising out of any liens, including, but not limited to, mechanics' and materialmen's liens, imposed on the Hope Center Lessee Parcel of such other Hope Center Lessee as a consequence of any work or labor done, supplies furnished, or services rendered at the request of the contracting Hope Center Lessee or any of its Users.

(c) Each Hope Center Lessee shall cause any property insurance policy obtained by it to provide that the insurance company waives all right of recovery by way of subrogation against any other Hope Center Lessee in connection with any damage covered by such property insurance policy to the personal and real property improvements located in or on the Hope Center Lessee Parcel or such other Hope

12-19-2019

Center Lessee and/or the Hope Center Project that are caused by or result from risks insured against under any property insurance policies carried by such Hope Center Lessee and in force at the time of any such damage.

ARTICLE 3  
MAINTENANCE AND ALTERATIONS

3.1 Maintenance of the Hope Center Lessee Parcels.

(a) Maintenance of the Permanent Supportive Housing Parcel.

(i) Maintenance of the Permanent Supportive Housing Parcel including the Berkeley Way Project-Serving Components located on the Permanent Supportive Housing Parcel and the Permanent Supportive Housing Hope Center Project-Serving Components shall be performed by the Permanent Supportive Housing Lessee. The Permanent Supportive Housing Lessee shall manage, maintain in good condition, repair, and replace the Hope Center Improvements on the Permanent Supportive Housing Parcel, except for those items (if any) which another Hope Center Lessee or Lessee (as defined in the Berkeley Way REA) has been designated to manage, maintain, repair, and replace as described in this Hope Center Declaration or the Berkeley Way REA.

(ii) The Temporary Housing Lessee shall have the right to perform Maintenance of the Permanent Supportive Housing Parcel to the extent necessary to mitigate an emergency situation. Before performing Maintenance under this paragraph, the Temporary Housing Lessee shall first take all reasonable steps to contact the Permanent Supportive Housing Lessee to permit such Hope Center Lessee to perform the necessary Maintenance.

(iii) Except as provided in Section 3.1(c) and (d), Section 3.2 and the Berkeley Way REA, the cost of Maintenance of the Permanent Supportive Housing Parcel shall be borne by the Permanent Supportive Housing Lessee provided that failure of the other Hope Center Lessees to tender its respective cost amount shall not relieve Temporary Housing Lessee from performing its required Maintenance under this Hope Center Declaration.

(b) Maintenance of the Temporary Housing Parcel.

(i) Maintenance of the Temporary Housing Parcel including the Berkeley Way Project-Serving Components and the Housing Hope Center Project-Serving Components located on the Temporary Housing Parcel shall be performed by the Temporary Housing Lessee. The Temporary Housing Lessee, shall manage, maintain in good condition, repair, and replace the Hope Center Improvements on the Temporary Housing Parcel, except for those items (if any) which another Hope Center Lessee or Lessee (as defined in the Berkeley Way REA) has been designated to manage, maintain, repair, and replace as described in this Hope Center Declaration or the Berkeley Way REA.



12-19-2019

(ii) The Permanent Supportive Housing Lessee shall have the right to perform Maintenance on the Temporary Housing Parcel to the extent necessary to mitigate an emergency situation. Before performing Maintenance under this paragraph, the Permanent Supportive Housing Lessee shall first take all reasonable steps to contact the Temporary Housing Lessee to permit such Hope Center Lessee to perform the necessary Maintenance.

(iii) Except as provided in Section 3.1(c) and (d), Section 3.2, and the Berkeley Way REA, the cost of Maintenance of the Temporary Housing Parcel shall be borne by the Temporary Housing Lessee provided that failure of the other Hope Center Lessees to tender its respective cost amount shall not relieve Temporary Housing Lessee from performing its required Maintenance under this Hope Center Declaration.

(c) Cost of Maintenance of Hope Center Project-Serving Components. The cost of Maintenance of the Hope Center Project-Serving Components shall be borne by the Hope Center Lessees in their Hope Center Designated Shares.

(d) Cost for Maintenance Caused by Another Hope Center Lessee. Subject to Section 2.4(c), the cost of any Maintenance of any Hope Center Parcel required as a result of any act or omission (including without limitation failure to timely perform its own Maintenance obligations) of the other Hope Center Lessee or its Users shall be borne solely by such Hope Center Lessee.

3.2 Specific Maintenance. Each Hope Center Lessee will coordinate its repair and Maintenance of any Hope Center Project-Serving Components with the Hope Center Joint Maintenance Committee. Costs to Maintain and repair Hope Center Project-Serving Components shall be allocated in a manner consistent with Article 5 and paid for with Hope Center Assessments or by other method of reimbursement agreed to by the Hope Center Lessees in writing.

3.3 Prohibited Alterations; Alterations to Hope Center Project-Serving Components.

(a) Subject to the requirements of the Leases, no Hope Center Lessee shall, without the prior written consent of the other Hope Center Lessees construct or alter any Hope Center Improvements on such Hope Center Lessee's Parcel that will do any of the following:

(i) Unreasonably interfere with any other Hope Center Lessee's use and enjoyment of its Hope Center Lessee Parcel;

(ii) Cause the termination or nonrenewal of insurance policies or an increase in insurance premiums for another Hope Center Lessee;

(iii) Adversely affect or impair the architectural integrity of the Hope Center Project or the appearance or aesthetics of a portion of a Hope Center Parcel that is visible from another Hope Center Parcel;

12-19-2019

(iv) Interfere with or alter the fire or acoustical rating of any wall separating a Hope Center Lessee Parcel from another Hope Center Lessee Parcel; or

(v) Violate the Hope Center Lessee's Lease.

(b) Prior to performing any alteration to any Hope Center Project-Serving Component located on a Hope Center Lessee Parcel (except for cosmetic alterations, such as painting, that are not visible from the exterior of the Hope Center Project or another Parcel), the Hope Center Lessee proposing to undertake the alteration shall:

(i) Provide the other Hope Center Lessees copies of the plans and specifications for the work to be performed; and

(ii) Request and obtain the written approval of the other Hope Center Lessees, which approval shall not be unreasonably withheld, conditioned, or delayed.

#### ARTICLE 4 USE RESTRICTIONS; OPERATIONS; TRANSFER

In addition to all of the covenants contained in this Hope Center Declaration, in the Berkeley Way REA and in the Leases, the use of the Hope Center Property is subject to the following:

4.1 Tenant Selection. Tenant and occupant admission and selection at the Permanent Supportive Housing Development and the Temporary Housing Development shall be performed in compliance with applicable law and the public funding requirements.

4.2 Regulatory Compliance. The Hope Center Lessees will comply with all regulatory and financing requirements applicable to their respective Hope Center Parcels in effect as of the date of this Agreement; and any use conflicting with such requirements shall be subject to the prior written approval of the Hope Center Lessees.

4.3 Services. Each Hope Center Lessee will provide services to its respective residents or occupants in compliance with Public Funding requirements, and as necessary to allow all other residents and occupants to enjoy and benefit from the Hope Center Project.

4.4 Transfer of Temporary Housing Development. From and after transfer of the Temporary Housing Development by the BFHP Hope Center Partnership to the BFHP Hope Center LLC, the Temporary Housing Lessee (and its successor) may not transfer any membership or ownership interest or transfer its interest in the Temporary Housing Lease without the prior written approval of the City and the Permanent Supportive Housing Lessee. The City and the Permanent Supportive Housing Lessee's consent shall be within their sole and absolute discretion. The provisions of this Section 4.4 are essential to the Hope Center Project given the integration of the Temporary

12-19-2019

Housing Development within the Hope Center Project and its proximity to the Permanent Supportive Housing Development. Nothing in this Section 4.4 is intended to prevent the City from exercising its rights to terminate the Temporary Housing Ground Lease pursuant to the terms of such lease or to prevent the City or County of Alameda from exercising any foreclosure rights under their financing for the Temporary Housing Development. However, if the City or County obtains fee or leasehold title to the Temporary Housing Parcel, the Permanent Supportive Housing Lessee shall have the right to review and approve the property manager and service provider for the Temporary Housing Development, as well as the operating budget and services plan.

## ARTICLE 5

### JOINT MAINTENANCE EXPENSES, ASSESSMENTS AND RESERVES

5.1 Berkeley Way REA Joint Maintenance Committee. The Berkeley Way REA establishes the Berkeley Way Joint Maintenance Committee. The Permanent Supportive Housing Lessee will serve as the member of the Berkeley Way Joint Maintenance Committee on behalf of the Permanent Supportive Housing Lessee and the Temporary Housing Lessee (the "BFHP Hope Center Committee Representative"). The BFHP Hope Center Representative may resign at, any time by giving written notice to the Hope Center Lessees.

5.2 Hope Center Joint Maintenance Committee. In order to determine those costs and expenses that are necessary to include in the Berkeley Way Annual Joint Expenses Budget established under the Berkeley Way REA, and in order to determine the Hope Center Annual Joint Expenses Budget, the Hope Center Lessees will operate a Hope Center Joint Maintenance Committee. Each Hope Center Lessee will appoint one representative to serve as a member of the Hope Center Joint Maintenance Committee. Each member of the Hope Center Joint Maintenance Committee may be removed from office at any time by his/her appointing Hope Center Lessee with or without cause. Any member of the Hope Center Joint Maintenance Committee may resign at any time by giving written notice to the appointing Hope Center Lessee and Hope Center Joint Maintenance Committee.

(a) Meetings. The Hope Center Joint Maintenance Committee shall meet annually, prior to the date that the Berkeley Way Joint Maintenance Committee will meet and in no event later than August 1 of each year, and at such other times as the members of the Hope Center Joint Maintenance Committee may determine. Both members of the Hope Center Joint Maintenance Committee must be present to conduct business and approve actions.

(b) Compensation. No member of the Hope Center Joint Maintenance Committee shall receive compensation for any service he or she may render to the Hope Center Joint Maintenance Committee.

5.3 Duties. The duties of the Hope Center Joint Maintenance Committee shall include (i) coordination of Maintenance of the Hope Center Project-Serving Components, and repair after damage or destruction to the Hope Center Project

12-19-2019

(Section 5.4 below); (ii) preparation of the Hope Center Annual Joint Expenses Budget (Section 5.5 below); (iii) establishing, levying and collecting Hope Center Joint Assessments (Sections 5.6 and 5.7 below); (iv) establishing and monitoring reserves for reasonably anticipated contingencies and repairs or replacements of Hope Center Project-Serving Components (Section 5.10 below). In the event the Hope Center Joint Maintenance Committee members cannot agree on a particular decision, following mediation under Section 7.12, the Permanent Supportive Housing Lessee member will control as to the decision provided that any such decision must be consistent with the terms of this Hope Center Declaration.

(a) Limitation of Liability. The members of the Hope Center Joint Maintenance Committee shall not be liable to the Hope Center Lessees, their Users, or other person for any injury, death, loss or damage due to theft, other breaches of security, failures, or interruption of services, or other circumstances pertaining to activities within the Hope Center Joint Maintenance Committee's control. Each member of the Hope Center Joint Maintenance Committee shall be entitled to indemnification by the Hope Center Lessees against all expenses, judgments, fines, settlements and other amounts actually and reasonably incurred in connection with any proceeding to which such member may be a party, or in which such member may become involved, by reason of the fact that he or she was or is a member of the Hope Center Joint Maintenance Committee.

#### 5.4 Coordination of Hope Center Joint Maintenance and Repair after Damage or Destruction.

(a) Maintenance Coordination. The Hope Center Joint Maintenance Committee is authorized to provide service to, and assure that, each BFHP Hope Center Project-Serving Component is operated, maintained, repaired, and replaced in a first-class condition, and otherwise in accordance with the standards of this Hope Center Declaration. Such authorization includes the right to inspect and monitor each Hope Center Lessee's Maintenance of Hope Center Project-Serving Components located on their respective Hope Center Lessee Parcel, coordinate Maintenance between Hope Center Lessees, and authorize contracts to perform any Maintenance the Hope Center Joint Maintenance Committee reasonably determines is not being properly performed.

(b) Damage or Destruction Repair Coordination. The Hope Center Joint Maintenance Committee is authorized to coordinate the repair or restoration activities necessitated by damage or destruction affecting more than one Hope Center Lessee Parcel, subject to the rights of Mortgagees. The Hope Center Joint Maintenance Committee shall have the right to authorize contracts to perform any repair or restoration work the Hope Center Joint Maintenance Committee reasonably determines is not being properly performed.

(c) Contracting. Permanent Supportive Housing Lessee (or any other Hope Center Lessee or property management agent selected by the Hope Center Joint Maintenance Committee), as the agent of the Hope Center Joint Maintenance

12-19-2019

Committee, shall have the right to solicit bids, enter into contracts with third parties on behalf of the Hope Center Joint Maintenance Committee, and take all other steps reasonably necessary or appropriate to perform the duties of the Hope Center Joint Maintenance Committee consistent with the then-current Hope Center Annual Joint Expenses Budget or as otherwise authorized to be undertaken by the Hope Center Joint Maintenance Committee; provided, however, that if the activities of the Hope Center Joint Maintenance Committee are necessitated by a Hope Center Lessee not performing its required Maintenance, repair or restoration activities, the costs incurred by the Hope Center Joint Maintenance Committee to perform such activities shall be a Hope Center Reimbursement Assessment charged pursuant to Section 5.8 below.

#### 5.5 Hope Center Annual Joint Expenses Budget.

(a) Before the meeting of the Berkeley Way Joint Maintenance Committee, and in any event by September 1 of each year, the Hope Center Joint Maintenance Committee shall meet to discuss the Hope Center Joint Expenses that the Hope Center Lessees expect to be incurred in the following calendar year. By October 1, the Hope Center Joint Maintenance Committee shall prepare and deliver to the Hope Center Lessees a written budget describing in reasonable detail the Hope Center Joint Expenses that the Hope Center Lessees expect to be incurred in the following calendar year (the "Hope Center Annual Joint Expenses Budget"). The Hope Center Annual Joint Expenses Budget shall also specify the contribution that each Hope Center Lessee must make, during the following calendar year, to its reserve account pursuant to Section 5.9(b).

(b) The Hope Center Annual Joint Expenses Budget shall account for all expected ordinary and extraordinary Hope Center Joint Expenses to be incurred in a calendar year, including expenses expected to be incurred by the Hope Center Joint Maintenance Committee for management, accounting or other services, and (ii) any previously unreconciled past payments of Hope Center Reimbursement Assessments for Hope Center Joint Expenses or Hope Center Joint Expenses Assessments for Hope Center Reimbursement Expenses. The Hope Center Annual Joint Expenses Budget shall also describe the following: (1) the current estimated replacement cost, estimated remaining life, and estimated useful life of each major component the Maintenance of which is a Hope Center Joint Expense; (2) the current estimate of the amount of cash reserves necessary to perform Maintenance on such major components; (3) the current estimate of accumulated cash reserves actually set aside by the Hope Center Lessees to perform Maintenance on such major components (as further discussed in Section 5.10); and (4) a statement addressing the procedures used for the calculation and establishment of those reserves to defray the Maintenance of major components the Maintenance of which is a Hope Center Joint Expense.

(c) The Hope Center Annual Joint Expenses Budget shall allocate Hope Center Joint Expenses to each Hope Center Lessee in proportion to their Hope Center Designated Shares except that each Hope Center Lessee shall be responsible for windows and doors primarily serving its respective Hope Center Parcel.

12-19-2019

(d) Unless one or more of the Hope Center Lessees objects in writing in a timely manner to the Hope Center Annual Joint Expenses Budget pursuant to Section 5.3(e) below, the Hope Center Annual Joint Expenses Budget shall be effective as of January 1 of the following year.

(e) If any affected Hope Center Lessee disputes the Hope Center Annual Joint Expenses Budget proposed by the Hope Center Joint Maintenance Committee and the Hope Center Lessees are unable to resolve their differences within a reasonable time, then the parties shall submit the Hope Center Annual Joint Expenses Budget in question to an arbitrator jointly selected by the parties (or if the Hope Center Lessees cannot agree on an arbitrator, then each Hope Center Lessee will select an arbitrator and the selected arbitrators will select a third arbitrator and the third arbitrator shall be the arbitrator to resolve the dispute over the Hope Center Annual Joint Expenses Budget). By December 25, the arbitrator shall confirm or revise the Hope Center Annual Joint Expenses Budget as the arbitrator determines to be appropriate, and such confirmed or revised Hope Center Annual Joint Expenses Budget shall be effective as of January 1 of the following year. The fees of the arbitrator or arbitrators shall be a Hope Center Joint Expense, but any other costs incurred in connection with the arbitration shall be borne by the Hope Center Lessee incurring such costs.

#### 5.6 Hope Center Joint Expenses Assessments.

(a) Each Hope Center Lessee's Hope Center Designated Share of Hope Center Joint Expenses, as set forth in the Hope Center Annual Joint Expenses Budget from time to time, shall be a charge levied against such Hope Center Lessee and its Hope Center Lessee Parcel and may be collected as the "Hope Center Joint Expenses Assessment", enforceable in the manner set forth in Section 5.7.

(b) The Hope Center Joint Maintenance Committee will from time to time select a Hope Center Lessee to receive and hold, in trust, the Hope Center Joint Expenses Assessments and make disbursements of such assessment for the payment of Hope Center Joint Expenses. Initially, the Hope Center Lessee to hold and disburse such payments is the Permanent Supportive Housing Lessee. Each Hope Center Lessee shall pay its annual Hope Center Joint Expenses Assessment in even monthly installments equal to one twelfth (1/12) of its annual Hope Center Joint Expenses Assessment, with each monthly installment due on the first day of each month of the year for which the applicable Hope Center Annual Joint Expenses Budget is effective. Notwithstanding the forgoing, the Hope Center Joint Maintenance Committee may request even quarterly payments in lieu of monthly payments. In addition, in lieu of collecting Hope Center Joint Expenses Assessments (either in whole or in part), the Hope Center Lessees may also choose and the Joint Maintenance Committee may require reimbursement of or payment to any Hope Center Lessee who pays for or coordinates Maintenance of a Hope Center Joint Expense.

(c) The Hope Center Joint Maintenance Committee shall oversee the use of the Hope Center Joint Expense Assessments received from the Hope Center

12-19-2019

Lessees pursuant to Section 5.5(b), and the performance of the activities whose costs constitute Hope Center Joint Expenses.

5.7 Hope Center Special Joint Expenses Assessments. In the event the Hope Center Joint Maintenance Committee determines, in good faith, that the Hope Center Annual Joint Expenses Budget is or will become inadequate for any reason (including, but not limited to, misinformation or miscalculation, unexpected repair or replacement of any Hope Center Project-Serving Component, or increase in estimates of Hope Center Joint Expenses, the Hope Center Joint Maintenance Committee may, at any time, levy an assessment (a "Hope Center Special Joint Expenses Assessment") to make up such inadequacy, which shall be allocated to the Hope Center Lessee(s) in accordance with the Hope Center Designated Shares.

5.8 Hope Center Reimbursement Assessments.

(a) A "Hope Center Reimbursement Expense" is, subject to Section 5.10(b), any expense actually incurred or expected to be incurred by a Hope Center Creditor Lessee that:

(i) is the financial responsibility of a Hope Center Debtor Lessee under this Hope Center Declaration;

(ii) arises out of noncompliance with this Hope Center Declaration (or any rule or regulation duly adopted pursuant to this Hope Center Declaration) by the Hope Center Debtor Lessee; or

(iii) arises out of inaction by the Hope Center Debtor Lessee that does not constitute noncompliance with this Hope Center Declaration.

(b) Every Hope Center Reimbursement Expense shall be a charge levied against the Hope Center Debtor Lessee and against the Debtor's Lessee Parcel, as applicable (a "Hope Center Reimbursement Assessment").

(c) Hope Center Reimbursement Expenses shall include actual and reasonable financing costs associated with the Hope Center Creditor Lessee advancing funds on behalf of the Hope Center Debtor Lessee from the time funds are advanced until the date on which the applicable Hope Center Reimbursement Assessment is paid.

(d) Hope Center Reimbursement Assessments shall be enforced in the manner set forth in Section 5.9.

5.9 Payment and Enforcement of Assessments.

(a) A Hope Center Creditor Lessee shall provide notice to a Hope Center Debtor Lessee of the amount and due date of any Hope Center Assessment. Notice shall be delivered not less than thirty (30) and not more than sixty (60) days prior to the Hope Center Assessment becoming due.

12-19-2019

(b) Each Hope Center Assessment obligation is a personal obligation of the Hope Center Debtor Lessee against whom the Hope Center Assessment is levied. Hope Center Assessments may be offset against each other unless one Hope Center Lessee objects in writing to an offset.

(c) Any Hope Center Assessment shall become delinquent if not paid within fifteen (15) days after the due date, and a Hope Center Creditor Lessee's reasonable costs in collecting the delinquent Hope Center Assessment (including reasonable attorneys' fees) may then be added to the Hope Center Assessment. Any Hope Center Assessment remaining unpaid as of thirty (30) days after the due date shall also have the following charges added to the Hope Center Assessment (together with the reasonable costs of collection, the "Additional Charges"): (i) interest at the lesser of twelve percent (12%) per annum and the maximum lawful rate; and (ii) a late charge equal to the greater of Ten Dollars (\$10) and ten percent (10%) of the delinquent Hope Center Assessment.

(d) If any Hope Center Assessment is not paid within thirty (30) days after its due date, then the Hope Center Creditor Lessee shall provide notice to the Hope Center Debtor Lessee (and shall simultaneously notify any Mortgagee who has requested a copy of the notice) stating: (i) that the Hope Center Assessment is delinquent; (ii) the action required to cure the default; (iii) a date, not less than thirty (30) days after the date of the notice, by which the default must be cured; and (iv) that failure to cure the default on or before the date specified in the notice may result in a lawsuit against the Hope Center Debtor Lessee. If a delinquent Hope Center Assessment and corresponding Additional Charges are not paid in full on or before the date specified in the notice, then the Hope Center Creditor Lessee may resort to the remedies set forth in Section 5.9(e) below.

(e) In the event any Hope Center Debtor Lessee fails to pay any Hope Center Assessment, any Hope Center Creditor Lessee(s) may, pursuant to Section 7.12 below, commence and maintain mediation, or enforce any other right or remedy available at law or equity, against the Hope Center Debtor Lessee obligated to pay such Hope Center Assessment. Any ruling rendered in any action shall include the amount of the delinquent Hope Center Assessment, Additional Charges, and any other amounts that the ruling body may award.

#### 5.10 Reserve Accounts.

(a) Each Hope Center Lessee shall establish and contribute to replacement and standard operating reserve accounts in the amount deemed appropriate by the Hope Center Joint Maintenance Committee to ensure such Hope Center Lessee's ability to pay its share of reasonably anticipated Hope Center Joint Expenses as may be projected to arise in future years, based on the analysis in the Hope Center Annual Joint Expenses Budget. On or about January 1 of each year, each Hope Center Lessee shall deliver to the Hope Center Joint Maintenance Committee evidence of the amount currently held in the delivering Hope Center Lessee's collective reserve accounts, including but not limited to replacement reserves, standard operating



12-19-2019

reserves and operating deficit reserves.

(b) A Hope Center Lessee's failure to deposit funds in its replacement and standard operating reserve account in a manner consistent with Section 5.10(a) will give rise to a Hope Center Reimbursement Assessment even if the other Hope Center Lessees do not make a contribution to their own reserve account to the extent necessary to compensate for the failing Hope Center Lessee's failure to contribute to its reserve account.

#### 5.11 Other Reports.

(a) For any year in which the Hope Center Assessments payable by a Hope Center Lessee exceed Fifteen Thousand Dollars (\$15,000), a review of the relevant supporting documents and financial statements of such Hope Center Lessees shall be prepared in accordance with generally accepted accounting principles by a licensee of the California State Board of Accountancy, and provided to the City. A Hope Center Lessee whose relevant supporting documents and financial statements must be reviewed pursuant to this Section shall distribute to the other Hope Center Lessees a copy of such review within one hundred twenty (120) days after the close of each fiscal year for which such a review must be prepared. The dollar amounts in this Section 5.11 shall be increased each year by CPI (as defined in the Berkeley Way REA) (or by the increase in a similar index if the described index is no longer published).

(b) Unless otherwise agreed to by the Hope Center Lessees, following completion of the construction of the Hope Center Project, at least once every five (5) years, the Hope Center Joint Maintenance Committee shall perform a physical needs assessment of the Hope Center Project, and provide a copy to the City. In addition, following completion of the construction of the Hope Center Project, at least one every five (5) years the Hope Center Joint Maintenance Committee shall cause a study of the reserve requirements of the Hope Center Property (and the cost of such study shall be a Hope Center Joint Expense), and provide a copy to the City. The study shall include the following items:

(i) Identification of the major components the Maintenance of which is a Hope Center Joint Expense and which have, as of the date of the study, a useful life of less than thirty (30) years.

(ii) Identification of the probable remaining useful life of the components identified in Section 5.11(b)(i), as of the date of the study.

(iii) An estimate of the cost of Maintenance of the components identified in Section 5.11(b)(i), both during and at the end of their useful life.

(iv) An estimate of the total annual contribution necessary to defray the cost to Maintain the components identified in Section 5.11(b)(i), both during and at the end of their useful life, taking into account the amount of reserve funds that are available for Maintenance of such components as of the date of the study.

12-19-2019

5.12 Rights of Mortgagees. A Mortgagee shall be protected against Hope Center Assessments levied prior to foreclosure (or deed-in-lieu) of the lender's deed of trust. In other words, no Hope Center Assessment levied prior to foreclosure (or deed-in-lieu) of a lender's deed of trust shall result in liability for such lender (or another transferee through foreclosure) after the foreclosure.

(a) After coming into possession of a Hope Center Lessee Parcel through foreclosure or deed in lieu of foreclosure, a Mortgagee (or any party coming into ownership of the Hope Center Lessee Parcel through the Mortgagee) shall be subject to all Hope Center Assessments levied after the foreclosure sale or transfer in lieu of foreclosure other than Hope Center Assessments based on obligations accruing, or defaults hereunder arising prior to the date of such foreclosure or transfer in lieu of foreclosure.

## ARTICLE 6 INSURANCE

The Hope Center Lessees will comply with the insurance provision in the Berkeley Way REA.

## ARTICLE 7 GENERAL PROVISIONS

7.1 Enforcement. Subject to Section 7.12 below, each Hope Center Lessee, or successor thereto shall have the right to enforce, by any proceeding at law or in equity, all restrictions, conditions, covenants, easements, and reservations now or hereafter imposed by the provisions of this Hope Center Declaration. Failure of any Hope Center Lessee to enforce any covenant or restriction in this Hope Center Declaration shall in no event be deemed a waiver of the right to do so thereafter.

7.2 Invalidity of Any Provision. Should any provision or portion of this Hope Center Declaration be declared invalid or in conflict with any applicable law, the validity of all other provisions and portions hereof shall remain unaffected and in full force and effect.

7.3 Term; Covenants Run with the Land. The Hope Center Easements created by and the covenants and restrictions of this Hope Center Declaration shall run with and bind the Hope Center Property and each of the Hope Center Parcels in perpetuity and shall inure to the benefit of and shall be enforceable by each Hope Center Lessee and the Hope Center Lessee's respective legal representatives, heirs, successors, subtenants and assigns. It is intended that the covenants, easements, agreements, promises and duties of each Hope Center Lessee set forth in this Hope Center Declaration shall be construed as covenants and not as conditions, and that, to the fullest extent legally possible, all such covenants shall run with the land and/or constitute equitable servitudes as between the Hope Center Parcel of the respective covenantor, as the servient tenement, and the Hope Center Parcel of the respective covenantee, as the dominant tenement.

12-19-2019

7.4 Amendments. This Hope Center Declaration may only be amended in a writing executed by the Hope Center Lessees. Any amendment must be recorded and shall become effective upon being recorded in the Official Records.

(a) City Approval Rights. Notwithstanding the above, this Hope Center Declaration shall not be amended in any way or terminated without the prior written approval of the City.

(b) Mortgagee Approval Rights. Notwithstanding the above, this Hope Center Declaration shall not be amended or terminated without the prior written approval of each Mortgagee holding a Mortgage on a Hope Center Lessee Parcel.

(c) Limited Partner Approval Rights. Notwithstanding the above, this Hope Center Declaration shall not be amended or terminated without the prior written approval of the investor limited partners of the BFHP Hope Center Partnership, if applicable (the "Limited Partner"), which approval shall not be withheld unreasonably. Failure of any of the Limited Partner to respond in writing within forty-five (45) business days of receipt of a written request for approval of an amendment to or termination of this Hope Center Declaration, either by approving the amendment or termination or by stating specific reasons for withholding approval, shall be deemed to be approval by any such Limited Partner.

7.5 Hope Center Lessee's Compliance. Each Hope Center Lessee shall be liable for performance of, and is bound by and shall comply with, the provisions of this Hope Center Declaration and the Hope Center Project Rules.

7.6 City Manager Authority Limitations. Any amendment to this Hope Center Declaration, including any amendment which affects or relates to: (i) the grant of any easement, (ii) the permitted use of any Parcel, or (iii) any other material provision of this Hope Center Declaration, shall require approval by the City's City Council. Subject to the foregoing, the City's City Manager may issue without City Council approval any consent or approval which City is entitled to provide under this Hope Center Declaration, including without limitation consents under Section 4.4.

7.7 Singular and Plural; Gender. The singular and plural number and masculine, feminine and neuter gender shall each include the other where the context requires.

7.8 Notices, Demands and Communications. Except as otherwise provided in this Hope Center Declaration, formal notices, demands, and communications among the Hope Center Lessees shall be sufficiently given if, and shall not be deemed given unless, delivered personally, with a delivery receipt; sent by United States Postal Service, certified mail, return receipt requested or sent by reputable overnight delivery service with a receipt showing date of delivery, or by electronic transmission with follow-up by one of the previous three methods, to the address of the Hope Center Declarant and Hope Center Lessees as follows:

12-19-2019

---



---

Such written notices, demands and communications may be sent in the same manner to such other addresses as the affected party may from time to time designate by notice to the other parties as provided in this Section. Delivery shall be deemed to have occurred at the time indicated on the receipt as the date of delivery, the date of refusal of delivery, or the date the item was returned as undeliverable.

7.9 No Discrimination. No Hope Center Lessee shall, either directly or indirectly, forbid or restrict the conveyance, encumbrance, leasing, mortgaging, or occupancy of its Hope Center Lessee Parcel, or a part thereof, to any person on account of race, color, creed, religion, sex, sexual orientation, marital status, ancestry, national origin, familial status, or handicap.

7.10 Rights of Mortgagees. The rights of a Hope Center Lessee under this Hope Center Declaration shall be subject to the rights of a Mortgagee to such Hope Center Lessee. No breach or violation of the Hope Center Declaration shall defeat or render invalid the lien of any Mortgage upon a Hope Center Lessee Parcel made in good faith and for value.

7.11 Hope Center Project Rules. Subject to the City's reasonable consent if requested by the City, the Hope Center Lessees may develop mutually acceptable rules (the "Hope Center Project Rules") to address matters pertaining to the mutually convenient use and operation of the Hope Center Project in addition to the matters set forth in this Hope Center Declaration and not inconsistent with the Berkeley Way Project Rules under the Berkeley Way REA. If the Hope Center Lessees cannot develop mutually acceptable Hope Center Project Rules then the Hope Center Lessees shall submit the issues in dispute to mediation in accordance with Section 7.12. The Hope Center Project Rules shall be in writing and copies shall be provided to both Hope Center Lessees, and all amendments to such Hope Center Project Rules must be in writing and approved by both Hope Center Lessees.

7.12 Dispute Resolution. In the event that the Hope Center Lessees are unable to agree on any aspect of the requirements of this Hope Center Declaration, or if there is a dispute as to a Hope Center Lessee's performance, then any Hope Center Lessee shall be entitled to mediation in accordance with the following procedures:

(a) Formal Mediation of Disputes. Any Hope Center Lessee may request the dispute be mediated through a mediation before a retired judge or justice from the Judicial Arbitration & Mediation Services, Inc., or its successor-in-interest, or such other alternative dispute resolution service reasonably acceptable to the Hope Center Lessees, (in each event such entity is referred to herein as "JAMS") pursuant to the mediation process described in this Section 7.12.

(b) Initiating Mediation. The Hope Center Lessee desiring the mediation (the "Requesting Party") shall send written notice to the other party (the

12-19-2019

"Receiving Party") in accordance with Section 7.8 requesting mediation. The Receiving Party shall have thirty (30) days from receipt of the written request to submit the matter to mediation. Within ten (10) days after receipt of the Receiving Party's agreement to submit the matter to mediation, the Requesting Party shall send written demand to the Dispute Resolution Administrator of JAMS (the "Administrator") at the office of JAMS in or closest to the City with the names, addresses, telephone numbers and e-mail addresses of all parties to this Hope Center Declaration and a brief synopsis of the claim, controversy, difference, or disputed matters and a proposed solution to the problem, with copies sent to the Receiving Party.

(c) Selection of Mediator. As soon as practicable after the demand is served upon JAMS, the Administrator will contact the Hope Center Lessees to select a mutually agreeable mediator. If the Hope Center Lessees have no particular mediator in mind or cannot agree on a mediator, the Administrator will submit a list of mediators, and their resumes, numbering at least one more than there are parties. Each Hope Center Lessee may then strike one name and the Administrator will designate the mediator from the list of remaining names.

(d) Hearings-Scheduling/Parties Present. After the mediator has been selected, the Hope Center Lessees shall promptly agree upon a date and time for the initial conference with the mediator, but no later than thirty (30) days after the date the mediator was selected. The Hope Center Lessees understand and agree that, besides counsel, each Hope Center Lessee may bring only such additional persons as are needed to respond to questions, contribute information and participate in the negotiations. The number of additional parties may be agreed upon in advance with the assistance and advice of the mediator.

(e) Position Papers. No later than seven (7) days before the first scheduled mediation session, each Hope Center Lessee shall deliver a concise written summary of its position, together with any appropriate documents, views and a proposed solution to the matters in controversy to the mediator and also serve a copy on all other parties.

(f) Participation by Mediator. Once familiar with the case, the mediator will give recommendations on terms of possible settlement conditions to be imposed upon the Hope Center Lessees (if appropriate). The mediator's opinion shall be based on the material and information then available to the Hope Center Lessees, excluding any information given to the mediator in confidence during a separate caucus. The opinions and recommendations of the mediator are not binding on the Hope Center Lessees.

(g) Confidentiality of Proceedings. The mediation process is to be considered settlement negotiation for the purpose of all state and federal rules protecting disclosures made during such conferences from the later discovery or use in evidence. The Hope Center Lessees agree that the provisions of California Evidence Code Section 1152.5 shall apply to any mediation conducted hereunder. The entire procedure is confidential, and no stenographic or other record shall be made except to

12-19-2019

memorialize a settlement record. All conduct, statements, promises, offers, views and opinions, oral or written, made during the mediation by any party or a party's agent, employee, or attorney are confidential and, where appropriate, are to be considered work product and privileged. Such conduct, statements, promises, offers, views and opinions shall not be subject to discovery or admissible for any purpose, including impeachment, in any litigation or other proceeding involving the parties; provided, however, that evidence otherwise subject to discovery or admissible is not excluded from discovery or admission in evidence simply as a result of it having been used in connection with this settlement process.

(h) Fees and Costs. The fees and costs of the mediation shall conform to the then current fee schedule at JAMS and, in the absence of a written agreement to the contrary, shall be shared equally by the parties in the mediation, but any other costs incurred in connection with the dispute resolution shall be borne by the Hope Center Lessee incurring such costs.

(i) Termination of Mediation Process. The mediation process shall continue until the matter is resolved, or the mediator makes a good faith finding that all settlement possibilities have been exhausted and there is no possibility of resolution through mediation. To the extent possible, mediation shall be conducted from 9:00 a.m. to 5:00 p.m., with a one (1)-hour break, on consecutive days. In no event shall a Hope Center Lessee be required to mediate for more than five (5) days.

(j) Condition Precedent to Litigation. The Hope Center Lessees agree and acknowledge that any dispute arising from this Hope Center Declaration brought before a court of competent jurisdiction shall first be subject to the mediation process, as set forth in this Section 7.12, as a condition precedent. Any such mediation shall be nonbinding except to the extent otherwise expressly provided herein.

Notwithstanding the foregoing, nothing in this Section 7.12 shall prohibit a Hope Center Lessee from pursuing the rights set forth in Section 7.15.

7.13 Default Shall not Permit Termination of Hope Center Declaration. No default under this Hope Center Declaration shall entitle any Hope Center Lessee to terminate, cancel or otherwise rescind this Hope Center Declaration; provided, however, that this limitation shall not affect any other rights or remedies that the Hope Center Lessees may have by reason of any default under this Hope Center Declaration.

7.14 Violation a Nuisance. The result of every act or omission whereby any provision of this Hope Center Declaration is violated in whole or in part is hereby declared to be a nuisance, and every remedy allowed by law or equity against a Hope Center Lessee for nuisance, either public or private, shall be available to and may be exercised by the other Hope Center Lessee.

7.15 Right to Enjoin/Specific Performance. In the event of any violation or threatened violation of any of the provisions of this Hope Center Declaration by a Hope Center Lessee or User, the other Hope Center Lessee shall have the right to apply to a

12-19-2019

court of competent jurisdiction for an injunction against such violation or threatened violation, or for specific performance of the subject provision, but nothing in this Section shall be deemed to affect whether or not injunctive relief or specific performance is available on account of such violation or threatened violation. The dispute resolution process set forth in Section 7.12 shall not apply to this Section 7.15.

7.16 Title of Parts and Sections. Any titles of the sections or subsections of this Hope Center Declaration are inserted for convenience of reference only and shall be disregarded in interpreting any part of the Hope Center Declaration's provisions.

7.17 Applicable Law. This Hope Center Declaration shall be interpreted under and pursuant to the laws of the State of California.

7.18 Legal Actions. Without limiting Section 7.12 above, if any legal action is commenced to interpret or to enforce the terms of this Hope Center Declaration or to collect damages as a result of any breach of this Hope Center Declaration, then the Hope Center Lessee prevailing in any such action shall be entitled to recover against the Hope Center Lessee not prevailing all reasonable attorneys' fees and costs incurred in such action (and any subsequent action or proceeding to enforce any judgment entered pursuant to an action on this Hope Center Declaration).

7.19 No Partnership; Joint Venture or Principal-Agent Relationship. Neither anything in this Hope Center Declaration nor any acts of the Hope Center Lessees shall be deemed by any Hope Center Lessee, or by any third Person, to create the relationship of principal and agent, or of partnership, or of joint venture, or of any association between the Hope Center Lessees.

7.20 Hope Center Declaration for Exclusive Benefit of the Hope Center Lessees. Except for provisions expressly stated to be for the benefit of a Mortgagee or the City, the provisions of this Hope Center Declaration are for the exclusive benefit of the Hope Center Lessees and successors and assigns, and not for the benefit of, nor give rise to any claim or cause of action by, any third Person.

7.21 Estoppel Certificate. Within ten (10) days after a written request of a Hope Center Lessee, the other Hope Center Lessee shall, issue to such requesting Hope Center Lessee or the City, or to any Mortgagee, or to any prospective purchaser or prospective Mortgagee specified by such requesting Hope Center Lessee, or to any other Person reasonably designated by the requesting Hope Center Lessee, or to the City (if required by the City), an estoppel certificate stating: (a) whether the Hope Center Lessee to whom the request has been directed knows of any default under this Hope Center Declaration and, if there are known defaults, specifying the nature thereof; (b) whether to such Hope Center Lessee's knowledge this Hope Center Declaration has been modified or amended in any way (or if it has, then stating the nature thereof); and (c) that to the Hope Center Lessee's knowledge this Hope Center Declaration as of that date is in full force and effect or, if not, so stating.

7.22 No Dedication. Nothing contained in this Hope Center Declaration shall

12-19-2019

be deemed to create or result in a dedication of any portion of the Hope Center Lessee Parcels for public use or to create any rights in the general public.

7.23 Time of Essence. Time is of the essence with respect to the performance of each of the covenants and agreements contained in this Hope Center Declaration.

7.24 Relationship to Berkeley Way REA. The Hope Center Declarants intend this Hope Center Declaration to be consistent with the Berkeley Way REA. To the extent of any conflict between the Berkeley Way REA and this Hope Center Declaration, the Berkeley Way REA shall control.

7.25 Multiple Originals; Counterparts. This Hope Center Declaration may be executed in multiple originals, each of which is deemed to be an original, and may be signed in counterparts.

7.26 Further Assurances. In addition to the actions recited herein and contemplated to be performed, executed, and/or delivered hereunder, each Hope Center Lessee will perform, execute and/or deliver or cause to be performed, executed and/or delivered any and all such further acts, instruments, deeds and assurances as may be reasonably required to provide for the use and operation of the Hope Center Property and the Hope Center Lessee Parcels in an efficient and coordinated manner as contemplated hereby.

7.27 City As Fee Owner. Unless and until the City is a Hope Center Lessee as defined in this Hope Center Declaration, it will have no responsibilities or liabilities under this Hope Center Declaration.

7.28 Severability. If any term of this Hope Center Declaration is held in a final disposition by a court of competent jurisdiction to be invalid, then the remaining terms shall continue in full force unless the rights and obligations of the Hope Center Lessees have been materially altered by such holding of invalidity.



DRAFT

12-19-2019

The undersigned has executed this Hope Center Declaration as of the Effective Date.

CITY OF BERKELEY

By: \_\_\_\_\_

Its: \_\_\_\_\_

BFHP HOPE CENTER LP,  
a California limited partnership

By: Hope Center Housing LLC,  
a California limited liability company,  
its managing general partner

By: BRIDGE Housing Corporation,  
a California nonprofit public benefit corporation,  
its co-member

By: \_\_\_\_\_  
Smitha Seshadri  
Executive Vice President

By: Berkeley Food and Housing Project,  
a California nonprofit religious corporation,  
its co-member

By: \_\_\_\_\_  
Callenne Egan  
Executive Director

[Signatures continue on following page]

DRAFT

12-19-2019

A notary public or other officer completing this certificate verifies only the identity of the individual who signed the document to which this certificate is attached, and not the truthfulness, accuracy, or validity of

STATE OF CALIFORNIA )  
 )  
COUNTY OF \_\_\_\_\_ )

On \_\_\_\_\_, before me, \_\_\_\_\_, Notary Public, personally appeared \_\_\_\_\_, who proved to me on the basis of satisfactory evidence to be the person(s) whose name(s) is/are subscribed to the within instrument and acknowledged to me that he/she/they executed the same in his/her/their authorized capacity(ies), and that by his/her/their signature(s) on the instrument the person(s), or the entity upon behalf of which the person(s) acted, executed the instrument.

I certify UNDER PENALTY OF PERJURY under the laws of the State of California that the foregoing paragraph is true and correct.

WITNESS my hand and official seal.

\_\_\_\_\_  
Name: \_\_\_\_\_  
Notary Public

DRAFT

12-19-2019

EXHIBIT A

(Hope Center Property Description)

DRAFT

12-19-2019

EXHIBIT B  
(Parcel Map)

DRAFT

12-19-2019

RECORDING REQUESTED BY:  
AND WHEN RECORDED MAIL TO:

Goldfarb & Lipman LLP  
1300 Clay Street, Eleventh Floor  
Oakland, CA 94612  
Attn: Heather Gould

---

---

**DECLARATION OF AND AGREEMENT REGARDING COVENANTS, CONDITIONS  
AND RESTRICTIONS  
PROVIDING FOR RECIPROCAL EASEMENTS, JOINT USE AND  
MAINTENANCE FOR THE BFHP HOPE CENTER**

TABLE OF CONTENTS

DRAFT  
Page

ARTICLE 1 DEFINITIONS ..... 2

    1.1 Definitions..... 2

    1.2 Exhibits..... 7

ARTICLE 2 DIVISION OF HOPE CENTER PROPERTY, GRANT OF EASEMENTS ..... 7

    2.1 General Description of Hope Center Property..... 7

    2.2 No Separate Conveyance of Hope Center Easements..... 7

    2.3 Grant of Hope Center Easements..... 7

    2.4 Hold Harmless..... 9

ARTICLE 3 MAINTENANCE AND ALTERATIONS..... 10

    3.1 Maintenance of the Hope Center Lessee Parcels..... 10

    3.2 Specific Maintenance..... 11

    3.3 Prohibited Alterations; Alterations to Hope Center Project-Serving Components..... 11

ARTICLE 4 USE RESTRICTIONS; OPERATIONS; TRANSFER ..... 12

    4.1 Tenant Selection..... 12

    4.2 Regulatory Compliance..... 12

    4.3 Services..... 12

    4.4 Transfer of Temporary Housing Development..... 12

ARTICLE 5 JOINT MAINTENANCE EXPENSES, ASSESSMENTS AND RESERVES..... 13

    5.1 Berkeley Way REA Joint Maintenance Committee..... 13

    5.2 Hope Center Joint Maintenance Committee..... 13

    5.3 Duties..... 13

    5.4 Coordination of Hope Center Joint Maintenance and Repair after Damage or Destruction..... 14

    5.5 Hope Center Annual Joint Expenses Budget..... 15

    5.6 Hope Center Joint Expenses Assessments..... 16

    5.7 Hope Center Special Joint Expenses Assessments..... 17

    5.8 Hope Center Reimbursement Assessments..... 17

    5.9 Payment and Enforcement of Assessments..... 17

    5.10 Reserve Accounts..... 18

    5.11 Other Reports..... 19

    5.12 Rights of Mortgagees..... 20

ARTICLE 6 INSURANCE ..... 20

TABLE OF CONTENTS  
(continued)

DRAFT  
Page

ARTICLE 7 GENERAL PROVISIONS..... 20

7.1 Enforcement..... 20

7.2 Invalidity of Any Provision..... 20

7.3 Term; Covenants Run with the Land..... 20

7.4 Amendments..... 21

7.5 Hope Center Lessee's Compliance..... 21

7.6 City Manager Authority Limitations..... 21

7.7 Singular and Plural; Gender..... 21

7.8 Notices, Demands and Communications..... 21

7.9 No Discrimination..... 22

7.10 Rights of Mortgagees..... 22

7.11 Hope Center Project Rules..... 22

7.12 Dispute Resolution..... 22

7.13 Default Shall not Permit Termination of Hope Center  
Declaration..... 24

7.14 Violation a Nuisance..... 24

7.15 Right to Enjoin/Specific Performance..... 24

7.16 Title of Parts and Sections..... 25

7.17 Applicable Law..... 25

7.18 Legal Actions..... 25

7.19 No Partnership; Joint Venture or Principal-Agent  
Relationship..... 25

7.20 Hope Center Declaration for Exclusive Benefit of the Hope  
Center Lessees..... 25

7.21 Estoppel Certificate..... 25

7.22 No Dedication..... 25

7.23 Time of Essence..... 26

7.24 Relationship to Berkeley Way REA..... 26

7.25 Multiple Originals; Counterparts..... 26

7.26 Further Assurances..... 26

7.27 City As Fee Owner..... 26

7.28 Severability..... 26

EXHIBIT A..... HOPE CENTER PROPERTY DESCRIPTION

EXHIBIT B..... PARCEL MAP

**OWNER'S STATEMENT**

(I, WE) HEREBY STATE THAT (I, WE) (AM, ARE) THE OWNER(S) OF, OR HAVE SOME RIGHT, TITLE OR INTEREST IN THE LAND DELINEATED AND EMBRACED WITHIN THE EXTERIOR BOUNDARY LINES ON THE HEREIN EMBODIED PARCEL MAP ENTITLED "PARCEL MAP 11051" CITY OF BERKELEY, COUNTY OF ALAMEDA, STATE OF CALIFORNIA". THAT (I, WE) CONSENT TO THE PREPARATION AND FILING OF THIS PARCEL MAP.

OWNER(S): CITY OF BERKELEY, A MUNICIPAL CORPORATION

BY: \_\_\_\_\_  
 NAME: \_\_\_\_\_  
 TITLE: \_\_\_\_\_

**OWNER'S ACKNOWLEDGEMENT**

A NOTARY PUBLIC OR OTHER OFFICE COMPLETING THIS CERTIFICATE VERIFIES ONLY THE IDENTITY OF THE INDIVIDUAL WHO SIGNED THE DOCUMENT TO WHICH THIS CERTIFICATE IS ATTACHED, AND NOT THE TRUTHFULNESS, ACCURACY, OR VALIDITY OF THE DOCUMENT.

STATE OF CALIFORNIA )  
 ) S.S.  
 COUNTY OF \_\_\_\_\_ )  
 ON \_\_\_\_\_, 20\_\_\_\_, BEFORE ME, \_\_\_\_\_, A NOTARY PUBLIC IN AND FOR SAID STATE, PERSONALLY APPEARED \_\_\_\_\_, WHO PROVED TO ME ON THE BASIS OF SATISFACTORY EVIDENCE TO BE THE PERSON(S) WHOSE NAME(S) IS/ARE SUBSCRIBED TO THE WITHIN INSTRUMENT AND ACKNOWLEDGED TO ME THAT HE/SHE/THEY EXECUTED THE SAME IN HIS/HER/THEIR AUTHORIZED CAPACITY(IES) AND THAT BY HIS/HER/THEIR SIGNATURE(S) ON THE INSTRUMENT, THE PERSON(S), OR THE ENTITY UPON BEHALF OF WHICH THE PERSON(S) ACTED, EXECUTED THE INSTRUMENT.

I CERTIFY UNDER PENALTY UNDER THE LAWS OF THE STATE OF CALIFORNIA THAT THE FOREGOING PARAGRAPH IS TRUE AND CORRECT.

WITNESS MY HAND AND OFFICIAL SEAL

SIGNATURE: \_\_\_\_\_ NOTARY PUBLIC  
 \_\_\_\_\_ PRINTED NAME

MY COMMISSION EXPIRES: \_\_\_\_\_  
 MY COMMISSION NUMBER: \_\_\_\_\_  
 COUNTY OF PRINCIPAL PLACE OF BUSINESS: \_\_\_\_\_

**SURVEYOR'S STATEMENT**

THIS MAP WAS PREPARED BY ME OR UNDER MY DIRECTION AND IS BASED UPON A FIELD SURVEY IN CONFORMANCE TO THE REQUIREMENTS OF THE SUBDIVISION MAP ACT AND LOCAL ORDINANCE AT THE REQUEST OF \_\_\_\_\_ IN AUGUST, 2019. I HEREBY STATE THIS PARCEL MAP CONFORMS TO THE APPROVED OR CONDITIONALLY APPROVED TENTATIVE PARCEL MAP, IF ANY. I HEREBY STATE THAT THE MONUMENTS ARE SUFFICIENT TO ENABLE THE SURVEY TO BE RETRACED.

DATE: \_\_\_\_\_ PRELIMINARY  
 \_\_\_\_\_  
 KELLY S. JOHNSON, PLS  
 L.S. NO. 9126

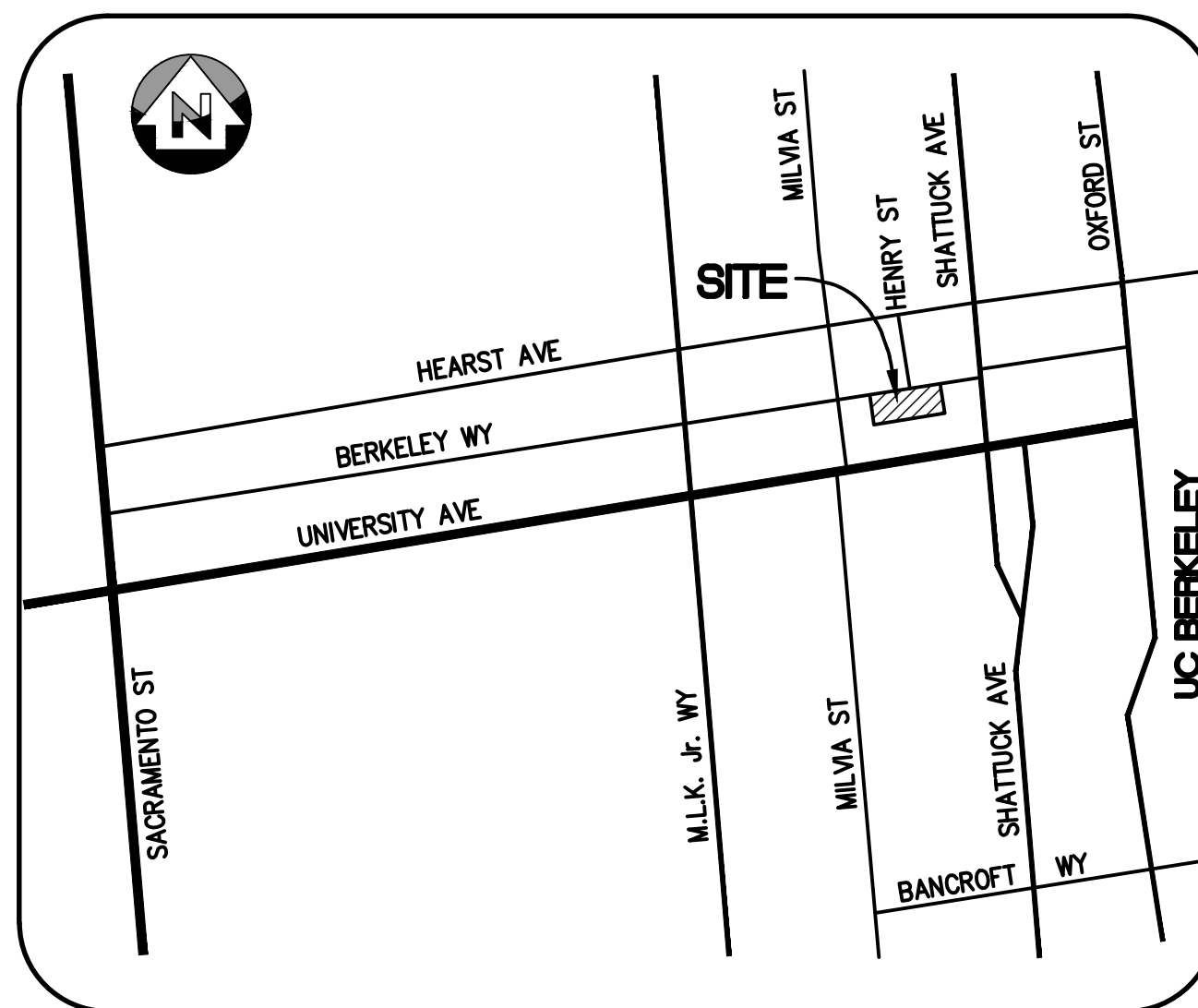

**VICINITY MAP**

N.T.S.

**CITY ENGINEER'S STATEMENT**

I HAVE EXAMINED THIS MAP AND THE SUBDIVISION AS SHOWN IS SUBSTANTIALLY THE SAME AS IT APPEARS ON THE TENTATIVE MAP (IF ANY) AND ANY APPROVED ALTERATIONS THEREOF. THIS MAP CONFORMS TO THE REQUIREMENTS OF THE SUBDIVISION MAP ACT AND LOCAL ORDINANCES. I AM SATISFIED THAT THIS MAP IS TECHNICALLY CORRECT.

DATE: \_\_\_\_\_  
 \_\_\_\_\_  
 NISHA A. PATEL, RCE 72491  
 CITY ENGINEER

**CITY CONSULTANT SURVEYOR'S STATEMENT**

THIS MAP CONFORMS TO THE REQUIREMENTS OF THE SUBDIVISION MAP ACT AND LOCAL ORDINANCES. I, \_\_\_\_\_, DO HEREBY STATE THAT IT HAS BEEN EXAMINED BY ME, OR UNDER DIRECTION BY CITY OF BERKELEY STAFF, AND I AM SATISFIED THAT IT IS TECHNICALLY CORRECT.

DATE: \_\_\_\_\_ PLS NO. \_\_\_\_\_

**PLANNING DIRECTOR'S STATEMENT**

THIS MAP HAS BEEN APPROVED BY THE PLANNING DIRECTOR, CITY OF BERKELEY ON 20\_\_\_\_, AND WHEN RECORDED BECOMES THE OFFICIAL MAP OF THIS LAND DIVISION.

DATE: \_\_\_\_\_  
 \_\_\_\_\_  
 TIMOTHY BURROUGHS  
 PLANNING DIRECTOR

**CLERK OF THE BOARD OF SUPERVISORS CERTIFICATE**

I, ANIKA CAMPBELL-BELTON, CLERK OF THE BOARD OF SUPERVISORS OF THE COUNTY OF ALAMEDA, STATE OF CALIFORNIA, DO HEREBY STATE THAT CERTIFICATES HAVE BEEN FILED AND DEPOSITS HAVE BEEN MADE IN CONFORMANCE WITH THE REQUIREMENTS OF SECTIONS 66492 AND 66493 OF THE GOVERNMENT CODE OF THE STATE OF CALIFORNIA.

ANIKA CAMPBELL-BELTON  
 CLERK OF THE BOARD OF SUPERVISORS OF THE COUNTY OF ALAMEDA, STATE OF CALIFORNIA  
 DATE: \_\_\_\_\_  
 BY: \_\_\_\_\_  
 DEPUTY COUNTY CLERK

**COUNTY RECORDER'S STATEMENT**

FILED THIS FOR RECORD THIS \_\_\_\_\_ DAY OF \_\_\_\_\_, 20\_\_\_\_, AT \_\_\_\_\_ M. IN BOOK \_\_\_\_\_ OR PARCEL MAPS, AT PAGES \_\_\_\_\_, AT THE REQUEST OF \_\_\_\_\_ TITLE COMPANY.

FEE: \_\_\_\_\_  
 SERIES: \_\_\_\_\_  
 MELISSA WILK  
 COUNTY RECORDER IN AND FOR THE COUNTY OF ALAMEDA, STATE OF CALIFORNIA

BY: \_\_\_\_\_  
 DEPUTY RECORDER

**INDEX:**

- SHEET 1 TITLE PAGE
- SHEET 2 LAND OF THE CITY OF BERKELEY
- SHEET 3 KEY MAP
- SHEET 4 PARCEL A LEVEL 1 DETAILS
- SHEET 5 PARCEL A LEVEL 2 DETAILS
- SHEET 6 PARCEL A LEVEL 3 AND UP DETAILS
- SHEET 7 PARCEL B LEVEL 1 DETAILS
- SHEET 8 PARCEL B LEVEL 2 DETAILS
- SHEET 9 PARCEL C LEVEL 1 DETAILS
- SHEET 10 PARCEL C LEVEL 2 DETAILS
- SHEET 11 PARCEL C LEVEL 3 AND UP DETAILS

**PARCEL MAP NO. 11051**

CONSISTING OF THREE AIR RIGHTS PARCELS  
 BEING A RESUBDIVISION OF PORTIONS OF LOTS 46-54 OF  
 "MAP OF COLLEGE TRACT", FILED ON JANUARY 31, 1880, IN MAP BOOK 9, PAGE 46  
 ALAMEDA COUNTY RECORDS AND THE WESTERN 1 FOOT OF LOT 55.

CITY OF BERKELEY COUNTY OF ALAMEDA

SEPTEMBER, 2019

CONSISTING OF 11 SHEETS

**SANDIS** CIVIL ENGINEERS SURVEYORS PLANNERS  
 1700 Winchester Boulevard, Campbell, CA 95008 | P. 408.636.0900 | F. 408.636.0999 | www.sandis.net  
 SILICON VALLEY TRI-VALLEY CENTRAL VALLEY SACRAMENTO EAST BAY/SF



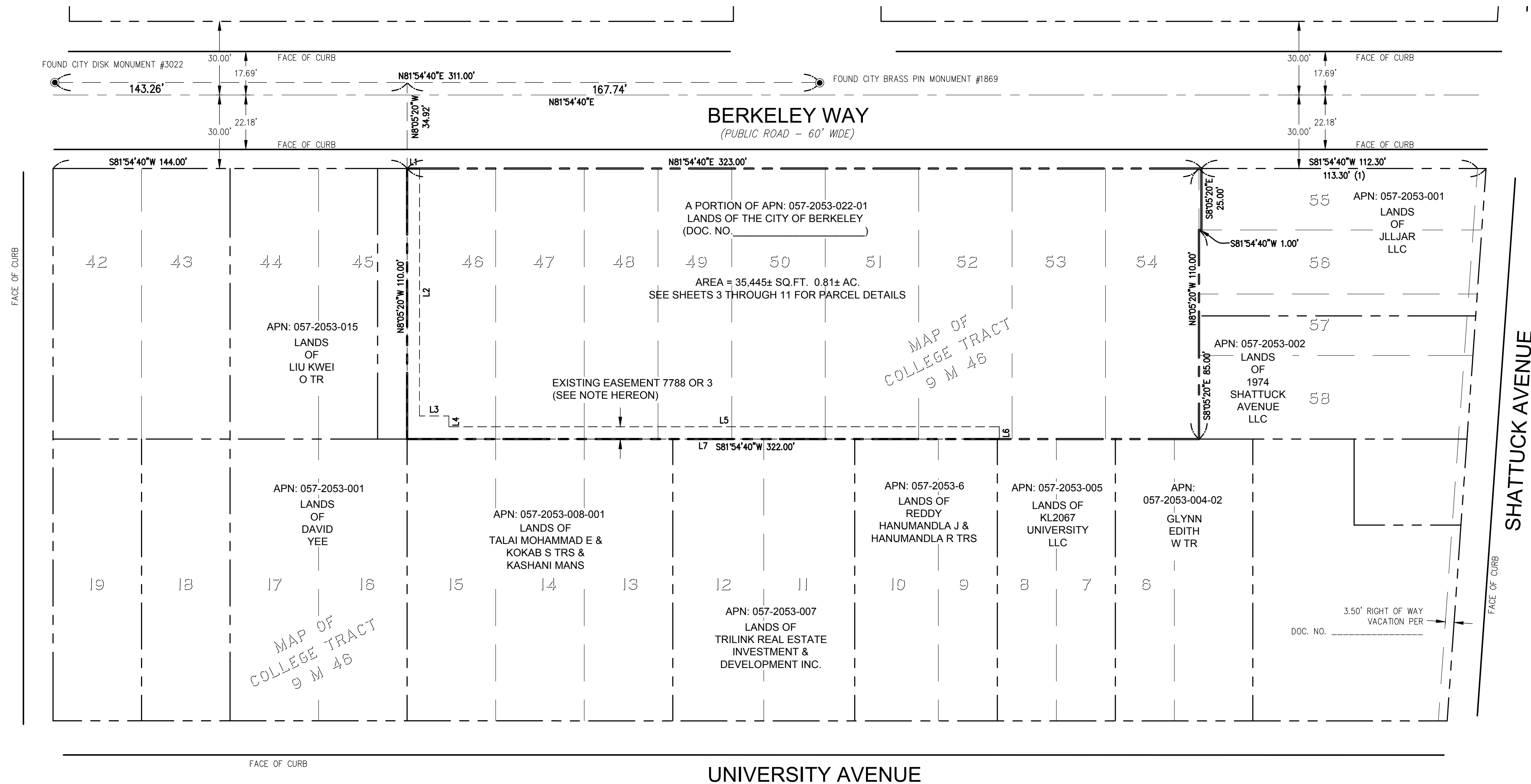

**BASIS OF BEARINGS**

THE BEARINGS SHOWN AS NORTH 81°54'40" EAST BETWEEN FOUND MONUMENTS, ON THE MONUMENT LINE OF BERKELEY WAY, AS DEPICTED ON TRACT MAP 7888, FILED SEPTEMBER 3, 2009 IN BOOK 305 OF MAPS, AT PAGES 18-20, ALAMEDA COUNTY RECORDS AND THE WESTERN 1 FOOT OF LOT 55.

**SURVEY REFERENCES**

- (1) MAP OF COLLEGE TRACT, BOOK 9 OF MAPS, PAGE 46, ALAMEDA COUNTY RECORDS
- (2) TRACT MAP NO. 7888, BOOK 305 OF MAPS, PAGE 20, ALAMEDA COUNTY RECORDS
- (3) EXISTING PEDESTRIAN PASSAGE EASEMENT BOOK 7788, PAGE 3
- (4) AN EASEMENT, NOT CLEARLY DEFINED OF RECORD, FOR PEDESTRIAN PASSAGE RECORDED SEPTEMBER 21, 1955, BOOK 7788, PAGE 3, OFFICIAL RECORDS. IT IS THE INTENT TO DEFINE THE LOCATION OF SAID EASEMENT TO THE AREA SHOWN HEREON AS "PRIVATE EMERGENCY EGRESS EASEMENT BENEFIT OF LOTS 9, 10, 11 AND 12", WHICH ARE ADJOINING LOTS SHOWN ON THE MAP OF COLLEGE TRACT BERKELEY.

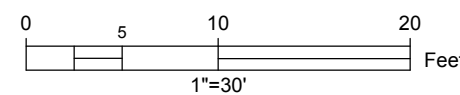

Line	Length	Direction
L1	5.01	N81° 55' 05.58"E
L2	100.62	S08° 05' 07.27"E
L3	12.00	N81° 52' 23.81"E
L4	4.38	S08° 05' 20.00"E
L5	223.80	N81° 54' 40.00"E
L6	5.00	S08° 05' 20.00"E
L7	240.81	S81° 54' 40.00"W

**LEGEND**

- SUBJECT EXTERIOR PROPERTY LINES
- VACATED LOT LINE
- AIR RIGHT PARCEL LINE
- FACE OF CURB
- CENTERLINE ROAD
- LOT LINE
- EASEMENT LINE (#)
- RECORD REFERENCE

NOTE: IT IS THE INTENT TO RELOCATE EXISTING EASEMENT 7788, PAGE 3 TO THE AREA SHOWN HEREON AS "EXISTING EASEMENT 7788 OR 3"

**PARCEL MAP NO. 11051**

CONSISTING OF THREE AIR RIGHTS PARCELS BEING A RESUBDIVISION OF PORTIONS OF LOTS 46-54 OF "MAP OF COLLEGE TRACT", FILED ON JANUARY 31, 1880, IN MAP BOOK 9, PAGE 46 ALAMEDA COUNTY RECORDS AND THE WESTERN 1 FOOT OF LOT 55.

CITY OF BERKELEY COUNTY OF ALAMEDA

SEPTEMBER, 2019

CONSISTING OF 11 SHEETS

**SANDIS** CIVIL ENGINEERS SURVEYORS PLANNERS  
 1700 Winchester Boulevard, Campbell, CA 95008 | P. 408.636.0900 | F. 408.636.0999 | www.sandis.net  
 SILICON VALLEY TRI-VALLEY CENTRAL VALLEY SACRAMENTO EAST BAY/SF

OWNER/SUBDIVIDER  
CITY OF BERKELEY

KEY MAP OF PARCELS

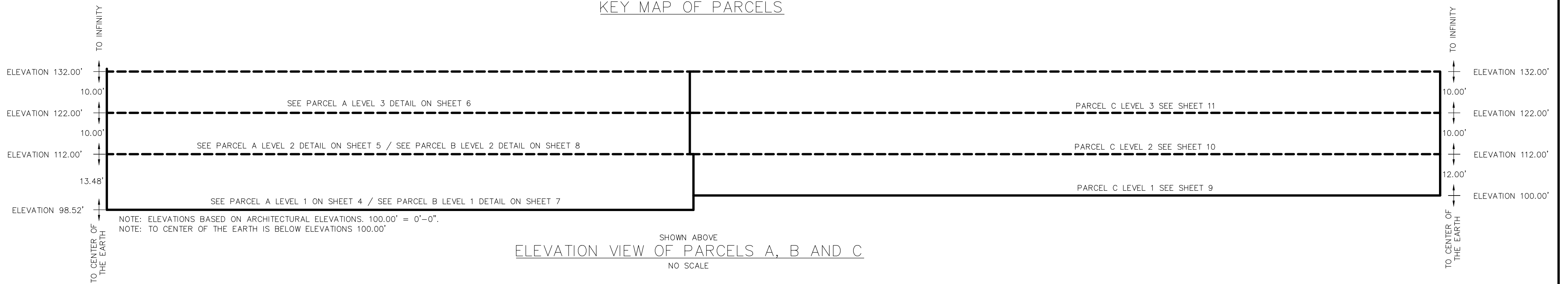

FOR PARCEL A DETAILS SEE SHEETS 4-6  
FOR PARCEL B DETAILS SEE SHEETS 7-8  
FOR PARCEL C DETAILS SEE SHEETS 9-11

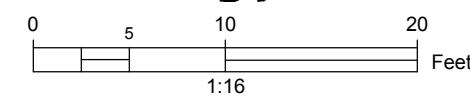
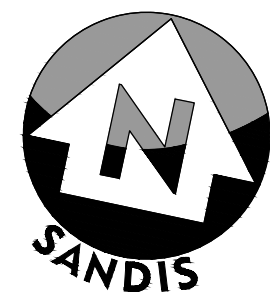

SHOWN ABOVE  
PARCEL A, B AND C LEVEL 1  
SCALE: 1"=16'

# PARCEL MAP NO. 11051

CONSISTING OF THREE AIR RIGHTS PARCELS  
BEING A RESUBDIVISION OF PORTIONS OF LOTS 46-54 OF  
"MAP OF COLLEGE TRACT", FILED ON JANUARY 31, 1880, IN MAP BOOK 9, PAGE 46  
ALAMEDA COUNTY RECORDS AND THE WESTERN 1 FOOT OF LOT 55.

CITY OF BERKELEY COUNTY OF ALAMEDA

SEPTEMBER, 2019

CONSISTING OF 11 SHEETS

**SANDIS** CIVIL ENGINEERS  
SURVEYORS  
PLANNERS

1700 Winchester Boulevard, Campbell, CA 95008 | P. 408.636.0900 | F. 408.636.0999 | www.sandis.net

SILICON VALLEY TRI-VALLEY CENTRAL VALLEY SACRAMENTO EAST BAY/SF

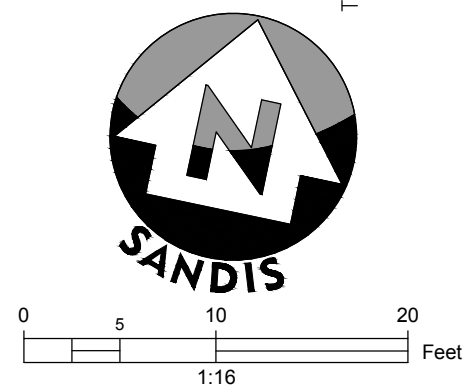
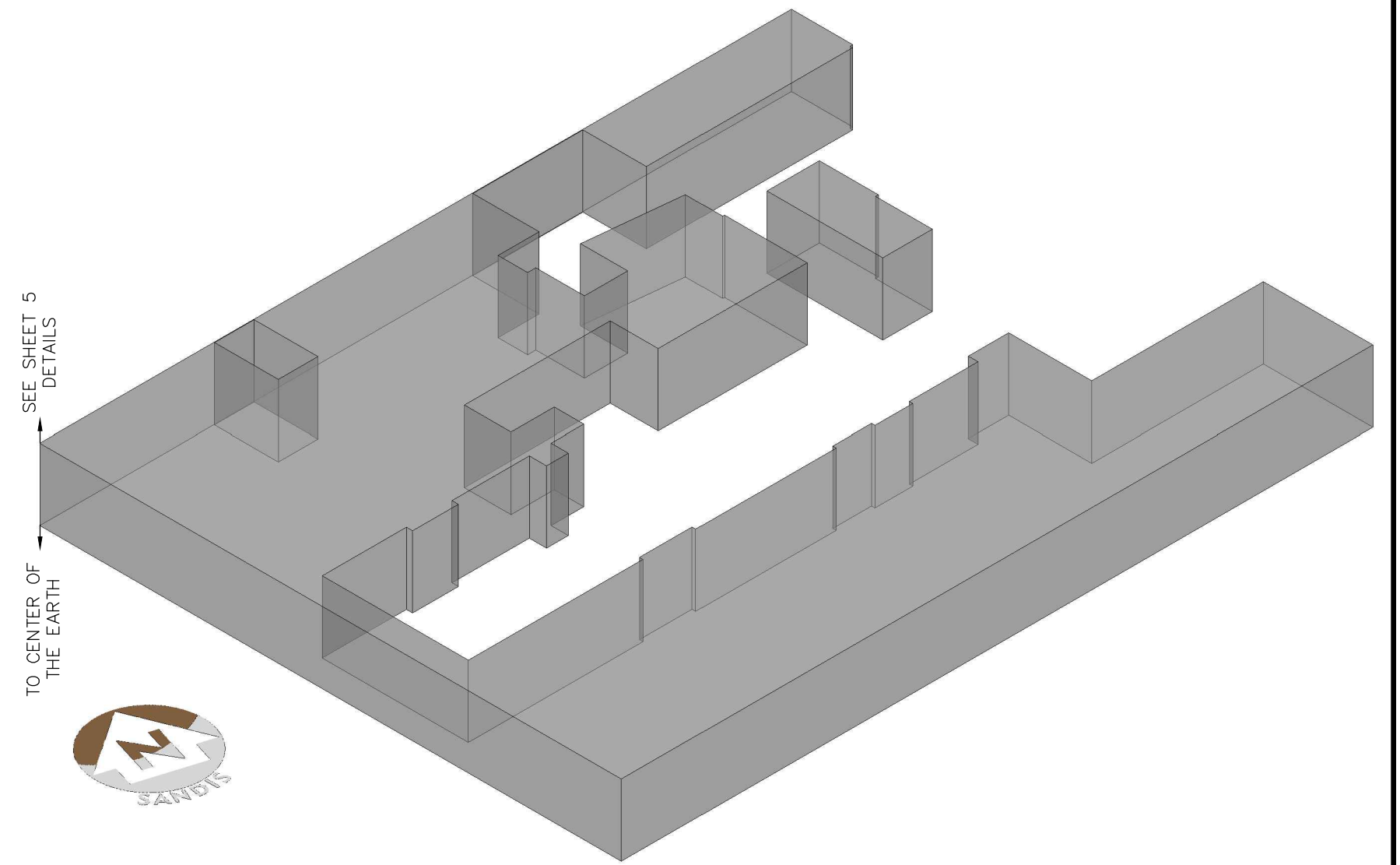
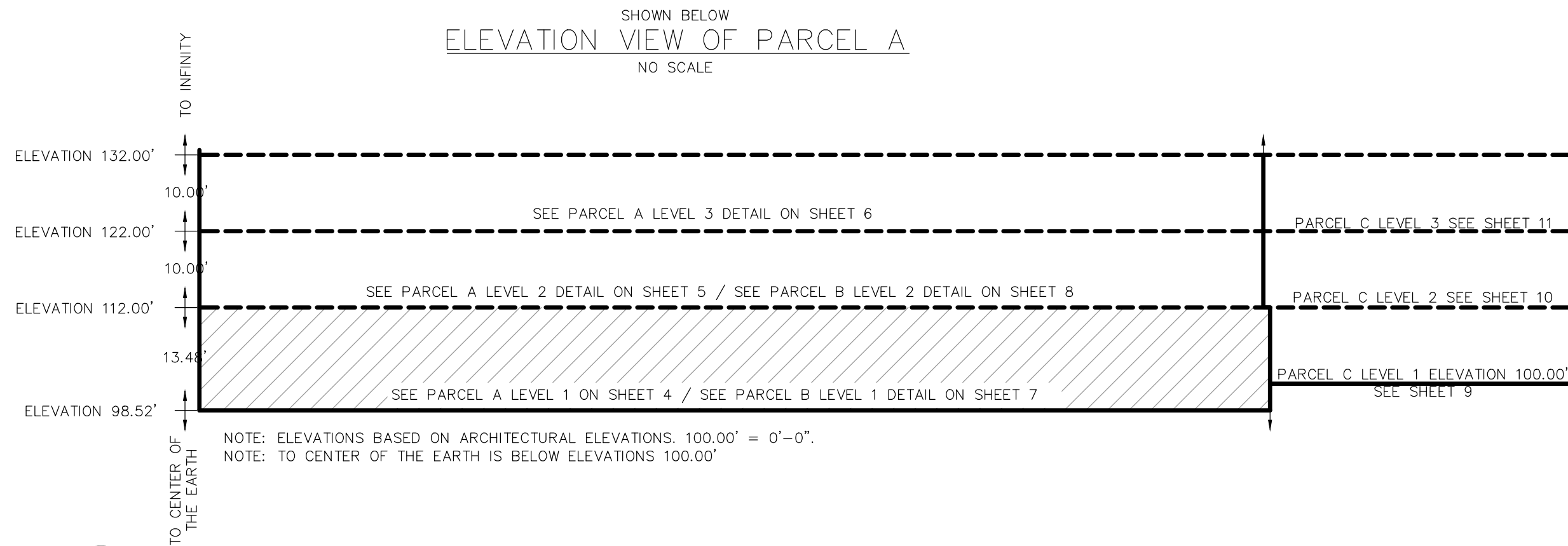

SHOWN BELOW  
PARCEL A LEVEL 1  
SCALE: 1"=16'

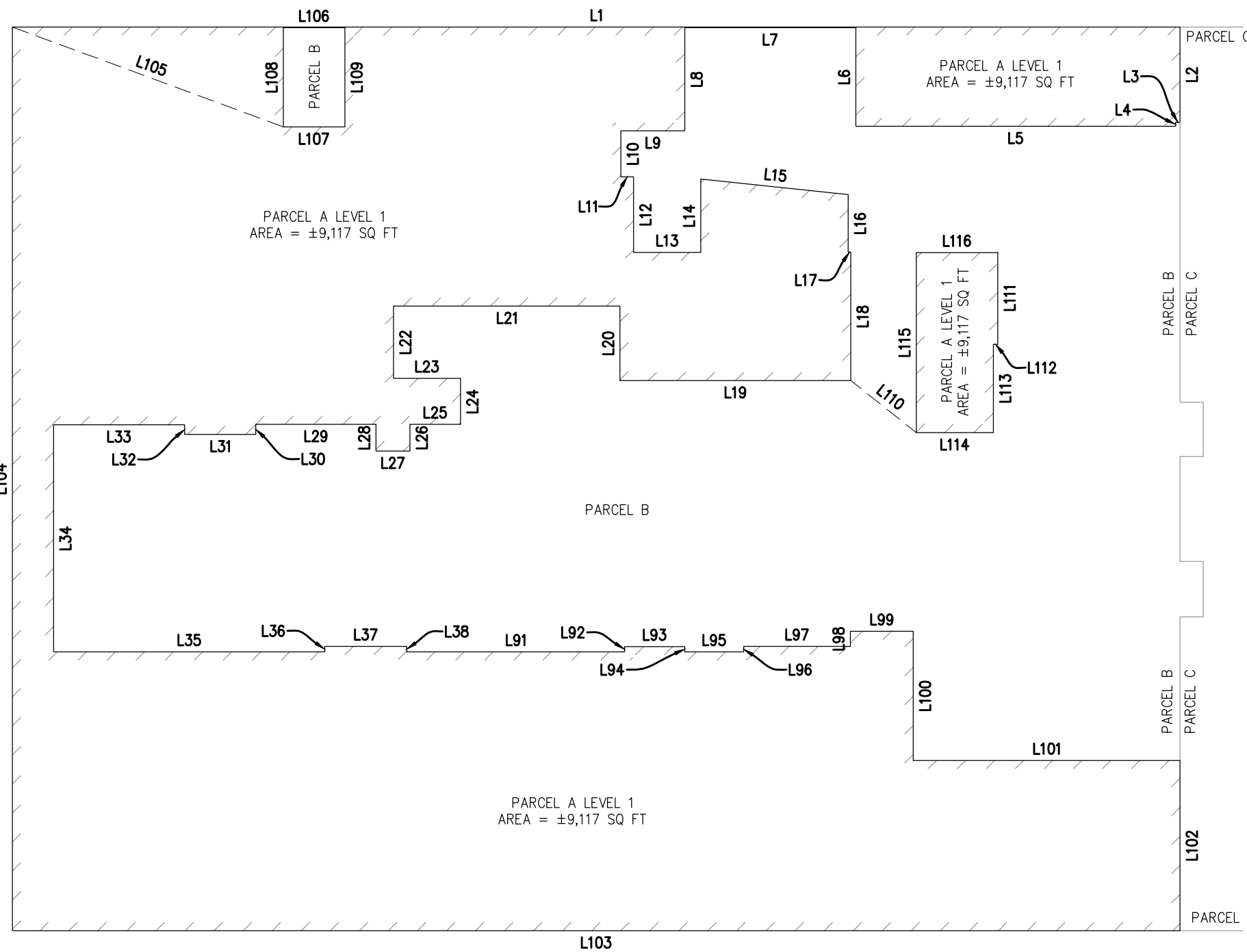

Line	Length	Direction
L1	142.10	N81° 54' 40.00"E
L2	11.59	S08° 05' 20.00"E
L3	0.52	S81° 54' 40.00"W
L4	0.50	S08° 05' 20.00"E
L5	38.93	S81° 54' 40.00"W
L6	12.00	N08° 05' 21.43"W
L7	20.83	S81° 54' 40.00"W
L8	12.55	S08° 05' 20.00"E
L9	7.77	S81° 54' 40.00"W
L10	5.59	S08° 05' 20.00"E
L11	1.55	N81° 54' 40.00"E
L12	9.20	S08° 05' 20.00"E
L13	8.18	N81° 54' 40.00"E
L14	8.93	N08° 05' 20.00"W
L15	18.02	N87° 54' 40.00"E
L16	7.03	S08° 05' 20.00"E
L17	0.33	N81° 54' 40.00"E
L18	15.62	S08° 05' 20.00"E
L19	28.09	S81° 54' 40.00"W
L20	9.08	N08° 05' 20.00"W

Line	Length	Direction
L21	27.58	S81° 54' 40.00"W
L22	8.82	S08° 05' 20.00"E
L23	8.18	N81° 54' 40.00"E
L24	5.59	S08° 05' 20.00"E
L25	6.18	S81° 54' 40.00"W
L26	3.26	S08° 05' 20.00"E
L27	4.13	S81° 54' 40.00"W
L28	3.26	N08° 05' 20.00"W
L29	14.62	S81° 54' 40.00"W
L30	1.22	S08° 05' 20.00"E
L31	8.68	S81° 54' 40.00"W
L32	1.17	N08° 05' 20.00"W
L33	15.93	S81° 54' 40.00"W
L34	27.65	S08° 05' 20.00"E
L35	33.01	N81° 54' 40.00"E
L36	0.67	N08° 05' 20.00"W
L37	9.97	N81° 54' 40.00"E
L38	0.67	S08° 05' 20.00"E
L39	26.52	N81° 54' 40.00"E
L40	0.65	N08° 05' 20.00"W

Line	Length	Direction
L93	7.33	N81° 54' 40.00"E
L94	0.65	S08° 05' 20.00"E
L95	7.17	N81° 54' 40.00"E
L96	0.67	N08° 05' 20.00"W
L97	12.99	N81° 54' 40.00"E
L98	1.83	N08° 05' 20.00"W
L99	7.65	N81° 54' 40.00"E
L100	15.71	S08° 05' 20.00"E
L101	32.47	N81° 54' 40.00"E
L102	20.72	S08° 05' 20.00"E
L103	142.10	S81° 54' 40.00"W
L104	110.00	N08° 05' 20.00"W
L105	35.14	S77° 49' 48.20"E
L106	7.49	N81° 54' 40.00"E
L107	7.49	S81° 54' 40.00"W
L108	12.07	N08° 05' 20.00"W
L109	12.07	S08° 05' 20.00"E
L110	10.18	S59° 36' 30.50"E
L111	11.16	S08° 05' 20.00"E
L112	0.53	S81° 54' 40.00"W

Line	Length	Direction
L113	10.75	S08° 04' 54.42"E
L114	9.38	S81° 54' 40.00"W
L115	21.91	N08° 05' 20.00"W
L116	9.92	N81° 54' 40.00"E

LEGEND

- BUILDING INTERIOR PARCEL LINE
- ADJACENT PARCEL LINE
- PARCEL TIE LINE
- LOT LINE

**PARCEL MAP NO. 11051**

CONSISTING OF THREE AIR RIGHTS PARCELS  
BEING A RESUBDIVISION OF PORTIONS OF LOTS 46-54 OF  
"MAP OF COLLEGE TRACT", FILED ON JANUARY 31, 1880, IN MAP BOOK 9, PAGE 46  
ALAMEDA COUNTY RECORDS AND THE WESTERN 1 FOOT OF LOT 55.

CITY OF BERKELEY COUNTY OF ALAMEDA

SEPTEMBER, 2019

CONSISTING OF 11 SHEETS

**SANDIS** CIVIL ENGINEERS  
SURVEYORS  
PLANNERS

1700 Winchester Boulevard, Campbell, CA 95008 | P. 408.636.0900 | F. 408.636.0999 | www.sandis.net

SILICON VALLEY TRI-VALLEY CENTRAL VALLEY SACRAMENTO EAST BAY/SF

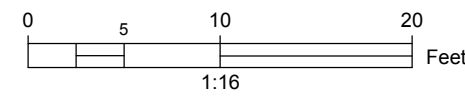
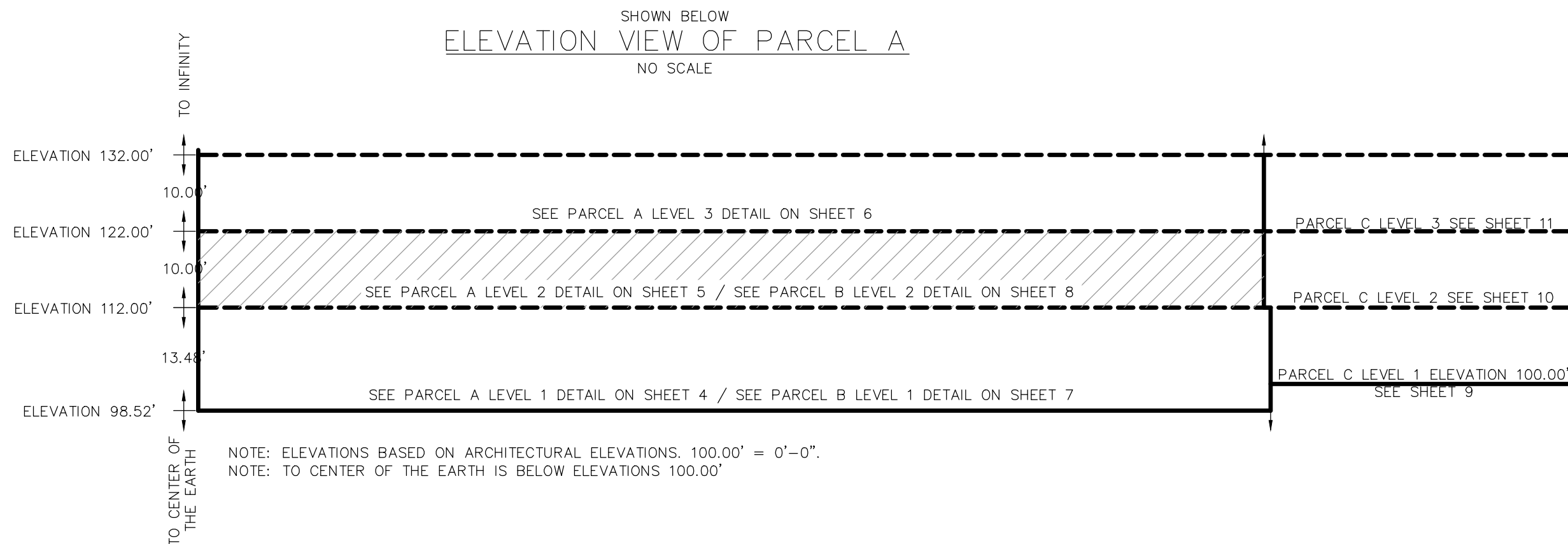

SHOWN BELOW  
**PARCEL A LEVEL 2**  
SCALE: 1"=16'

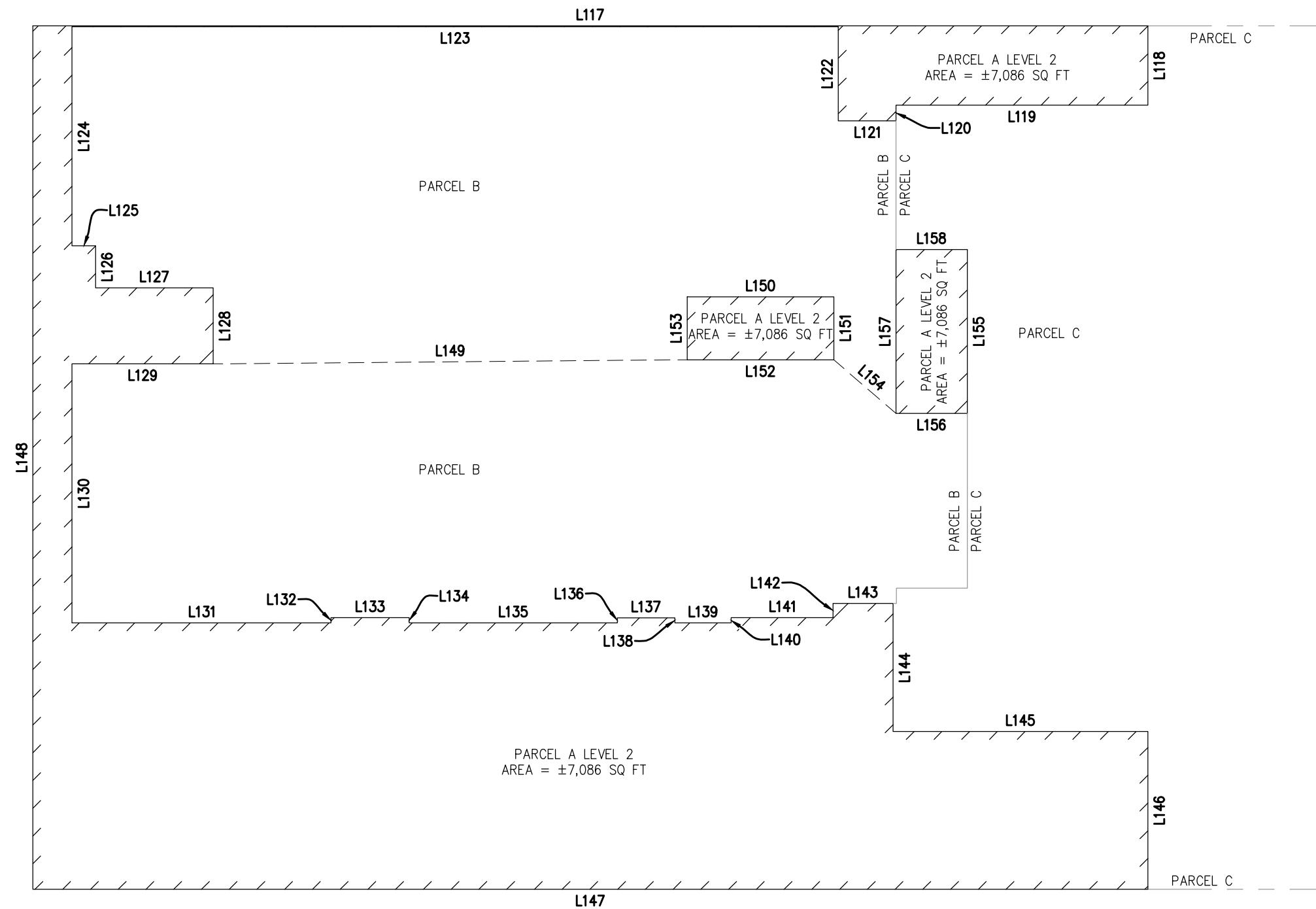

Line	Length	Direction
L117	142.10	N81° 54' 40.00"E
L118	10.09	S08° 05' 20.00"E
L119	32.09	S81° 54' 40.00"W
L120	2.00	S08° 05' 20.00"E
L121	7.35	S81° 54' 40.00"W
L122	12.00	N08° 05' 21.43"W
L123	97.65	S81° 54' 40.00"W
L124	27.94	S08° 05' 20.00"E
L125	3.00	N81° 54' 40.00"E
L126	5.35	S08° 05' 20.00"E
L127	14.99	N81° 54' 40.00"E
L128	9.68	S08° 05' 19.13"E
L129	17.99	S81° 54' 46.67"W
L130	33.01	S08° 05' 20.00"E
L131	33.01	N81° 54' 40.00"E
L132	0.67	N08° 05' 20.00"W
L133	9.97	N81° 54' 40.00"E
L134	0.67	S08° 05' 20.00"E
L135	26.52	N81° 54' 40.00"E
L136	0.65	N08° 05' 20.00"W

Line	Length	Direction
L137	7.33	N81° 54' 40.00"E
L138	0.65	S08° 05' 20.00"E
L139	7.17	N81° 54' 40.00"E
L140	0.67	N08° 05' 20.00"W
L141	12.99	N81° 54' 40.00"E
L142	1.83	N08° 05' 20.00"W
L143	7.65	N81° 54' 40.00"E
L144	16.33	S08° 05' 20.00"E
L145	32.47	N81° 54' 40.00"E
L146	20.09	S08° 05' 20.00"E
L147	142.10	S81° 54' 40.00"W
L148	110.00	N08° 05' 20.00"W
L149	60.41	N81° 24' 59.76"E
L150	18.67	N81° 54' 40.00"E
L151	8.02	S08° 05' 20.00"E
L152	18.67	S81° 54' 40.00"W
L153	8.02	N08° 05' 20.00"W
L154	10.47	S57° 19' 23.65"E
L155	20.89	S08° 05' 20.00"E
L156	9.08	S81° 54' 40.00"W

Line	Length	Direction
L157	20.89	N08° 05' 20.00"W
L158	9.08	N81° 54' 40.00"E

**LEGEND**

- BUILDING INTERIOR PARCEL LINE
- ADJACENT PARCEL LINE
- PARCEL TIE LINE
- LOT LINE

**PARCEL MAP NO. 11051**

CONSISTING OF THREE AIR RIGHTS PARCELS  
BEING A RESUBDIVISION OF PORTIONS OF LOTS 46-54 OF  
"MAP OF COLLEGE TRACT", FILED ON JANUARY 31, 1880, IN MAP BOOK 9, PAGE 46  
ALAMEDA COUNTY RECORDS AND THE WESTERN 1 FOOT OF LOT 55.

CITY OF BERKELEY COUNTY OF ALAMEDA

SEPTEMBER, 2019

CONSISTING OF 11 SHEETS

**SANDIS** CIVIL ENGINEERS  
SURVEYORS  
PLANNERS

1700 Winchester Boulevard, Campbell, CA 95008 | P. 408.636.0900 | F. 408.636.0999 | www.sandis.net

SILICON VALLEY TRI-VALLEY CENTRAL VALLEY SACRAMENTO EAST BAY/SF

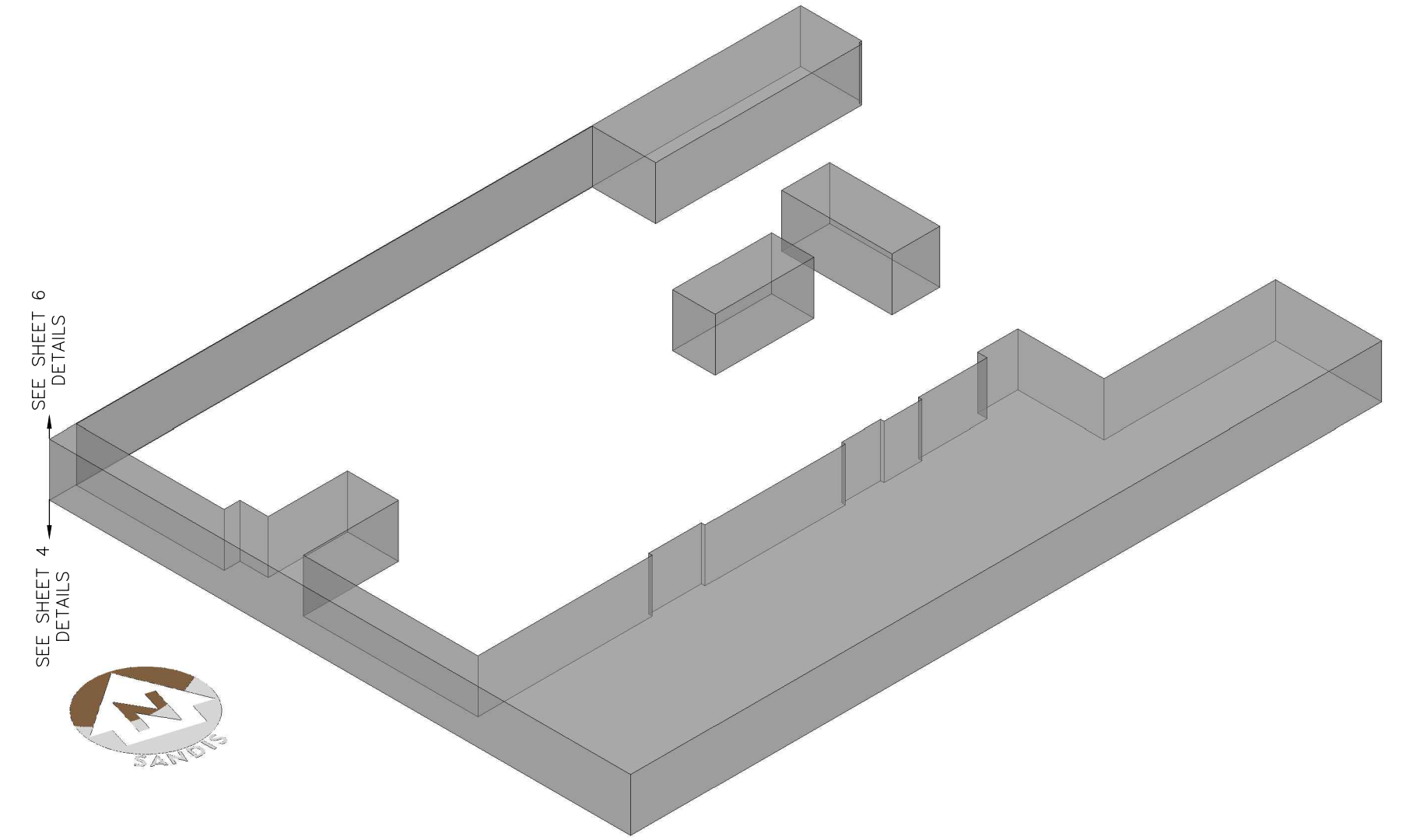



SHOWN BELOW  
ELEVATION VIEW OF PARCEL A  
NO SCALE

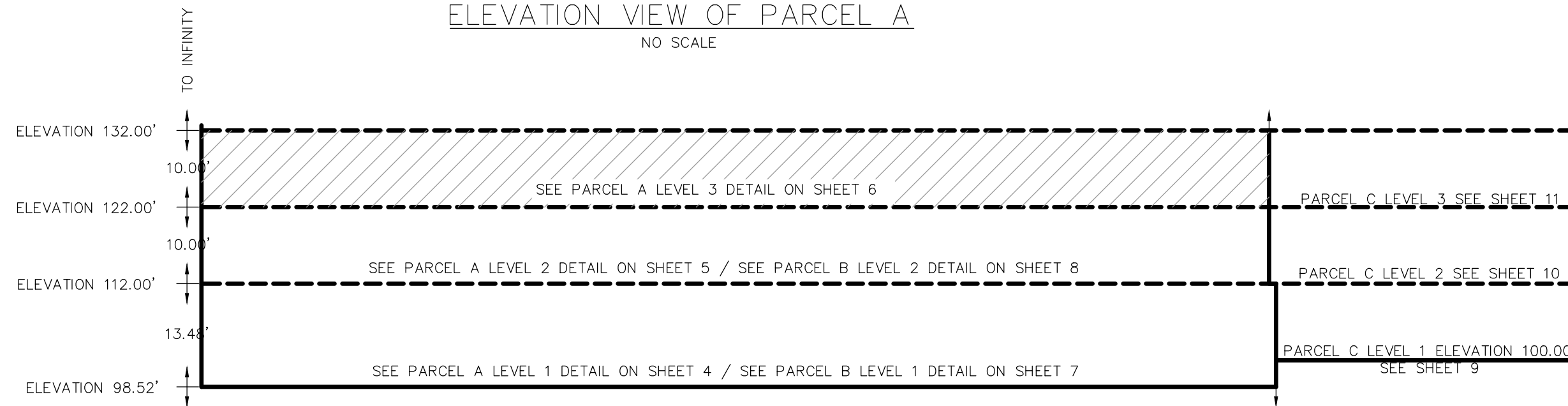

NOTE: ELEVATIONS BASED ON ARCHITECTURAL ELEVATIONS. 100.00' = 0'-0".  
NOTE: TO CENTER OF THE EARTH IS BELOW ELEVATIONS 100.00'

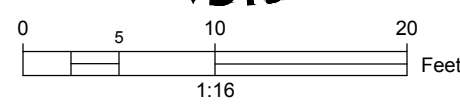

SHOWN BELOW  
PARCEL A LEVEL 3 AND UP  
SCALE: 1"=16'

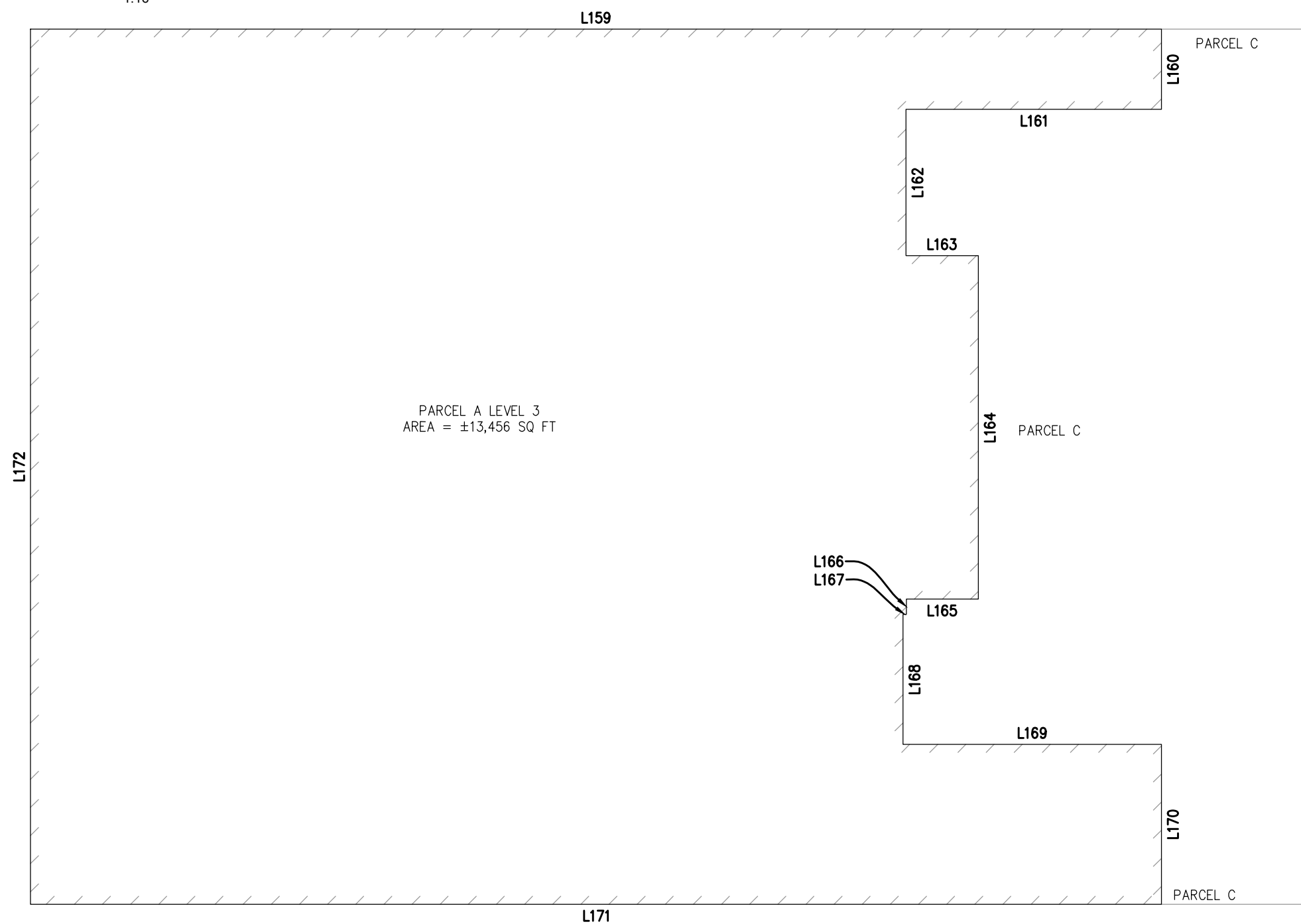

Line	Length	Direction
L159	142.10	N81° 54' 40.00"E
L160	10.09	S08° 05' 20.00"E
L161	32.09	S81° 54' 40.00"W
L162	18.40	S08° 05' 20.00"E
L163	9.08	N81° 54' 40.00"E
L164	43.16	S08° 05' 20.00"E
L165	9.02	S81° 54' 40.00"W
L166	1.93	S08° 05' 20.00"E
L167	0.44	S81° 54' 40.00"W
L168	16.33	S08° 05' 20.00"E
L169	32.47	N81° 54' 40.00"E
L170	20.09	S08° 05' 20.00"E
L171	142.10	S81° 54' 40.00"W
L172	110.00	N08° 05' 20.00"W

SHOWN ABOVE  
ISOMETRIC VIEW OF PARCEL A LEVEL 3  
SCALE: 1"=20'

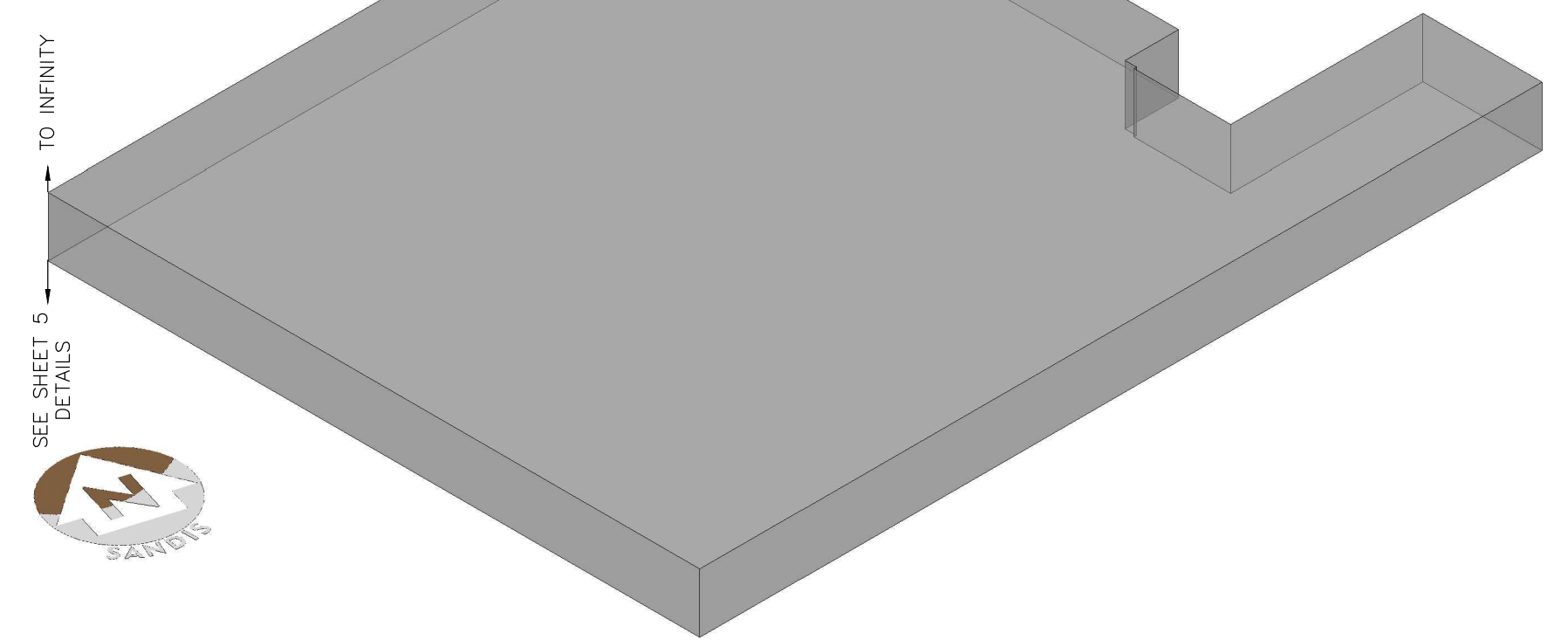

LEGEND

- BUILDING INTERIOR PARCEL LINE
- ADJACENT PARCEL LINE
- PARCEL TIE LINE
- LOT LINE

**PARCEL MAP NO. 11051**

CONSISTING OF THREE AIR RIGHTS PARCELS  
BEING A RESUBDIVISION OF PORTIONS OF LOTS 46-54 OF  
"MAP OF COLLEGE TRACT", FILED ON JANUARY 31, 1880, IN MAP BOOK 9, PAGE 46  
ALAMEDA COUNTY RECORDS AND THE WESTERN 1 FOOT OF LOT 55.

CITY OF BERKELEY COUNTY OF ALAMEDA

SEPTEMBER, 2019

CONSISTING OF 11 SHEETS

**SANDIS** CIVIL ENGINEERS  
SURVEYORS  
PLANNERS

1700 Winchester Boulevard, Campbell, CA 95008 | P. 408.636.0900 | F. 408.636.0999 | www.sandis.net

SILICON VALLEY TRI-VALLEY CENTRAL VALLEY SACRAMENTO EAST BAY/SF

SHOWN BELOW  
ELEVATION VIEW OF PARCEL B  
NO SCALE

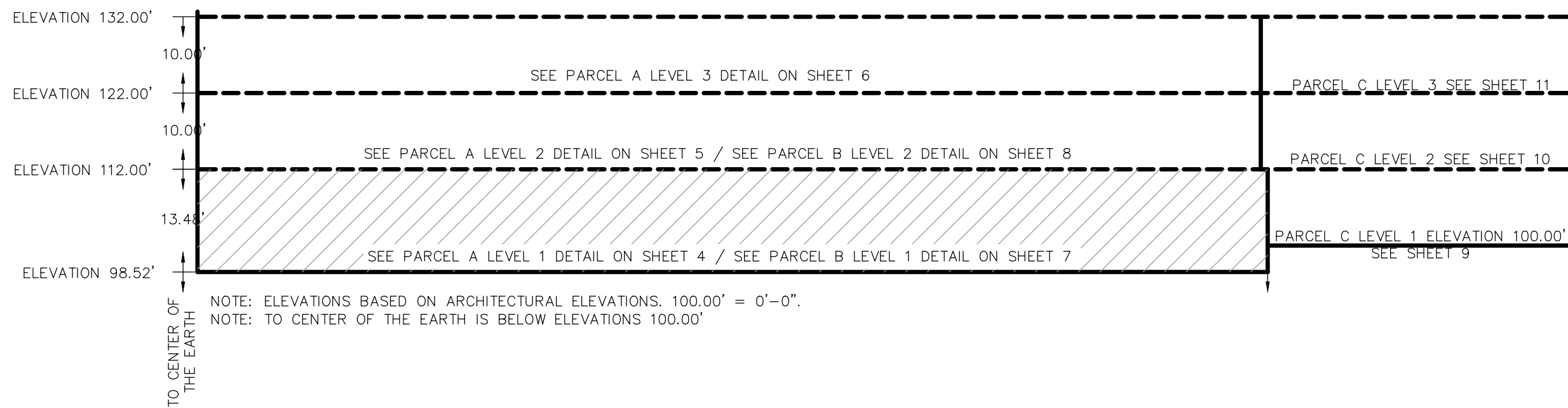

NOTE: ELEVATIONS BASED ON ARCHITECTURAL ELEVATIONS. 100.00' = 0'-0".  
NOTE: TO CENTER OF THE EARTH IS BELOW ELEVATIONS 100.00'

SEE DETAILS ON SHEET 8

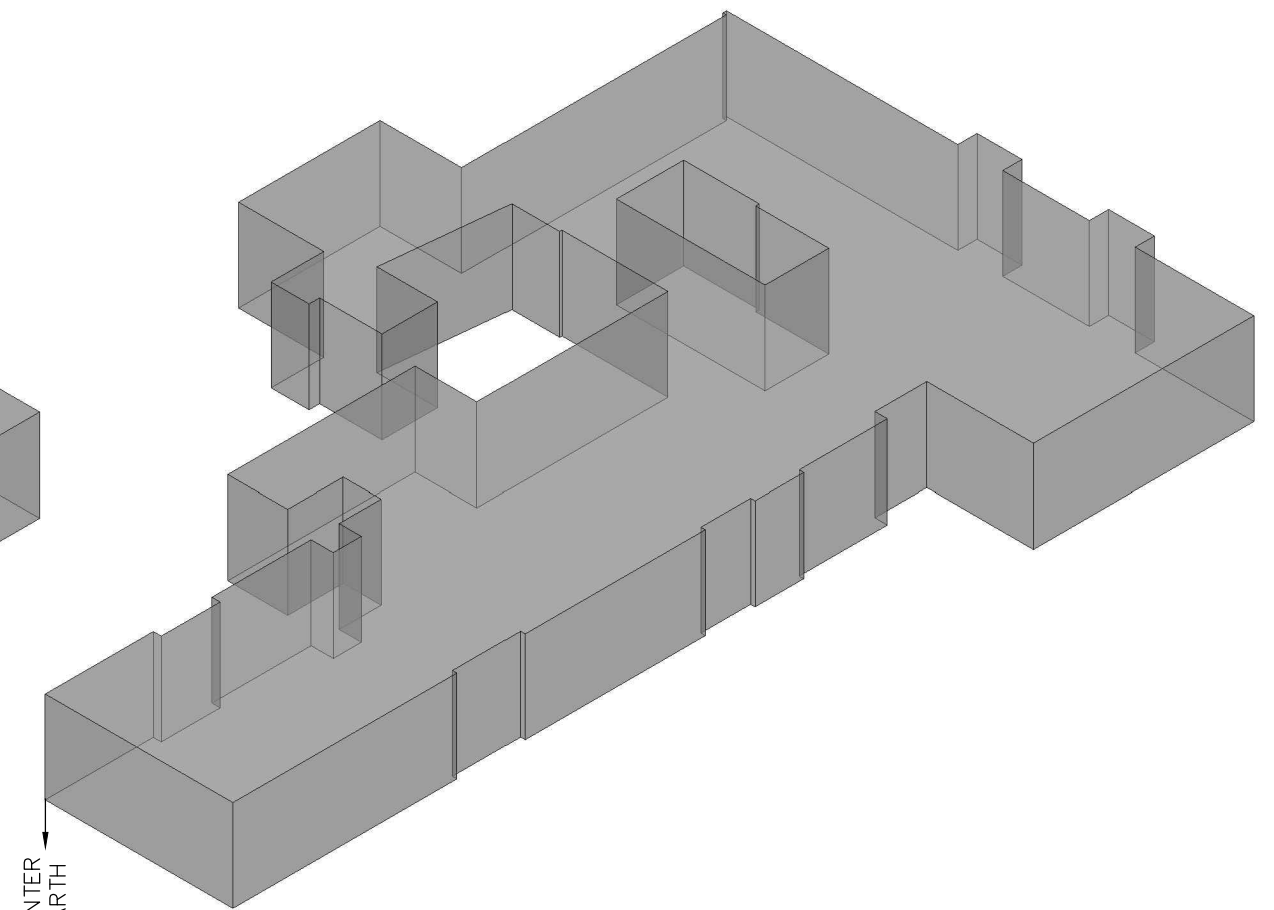

SHOWN ABOVE  
ISOMETRIC VIEW OF PARCEL B LEVEL 1  
SCALE: 1"=20'

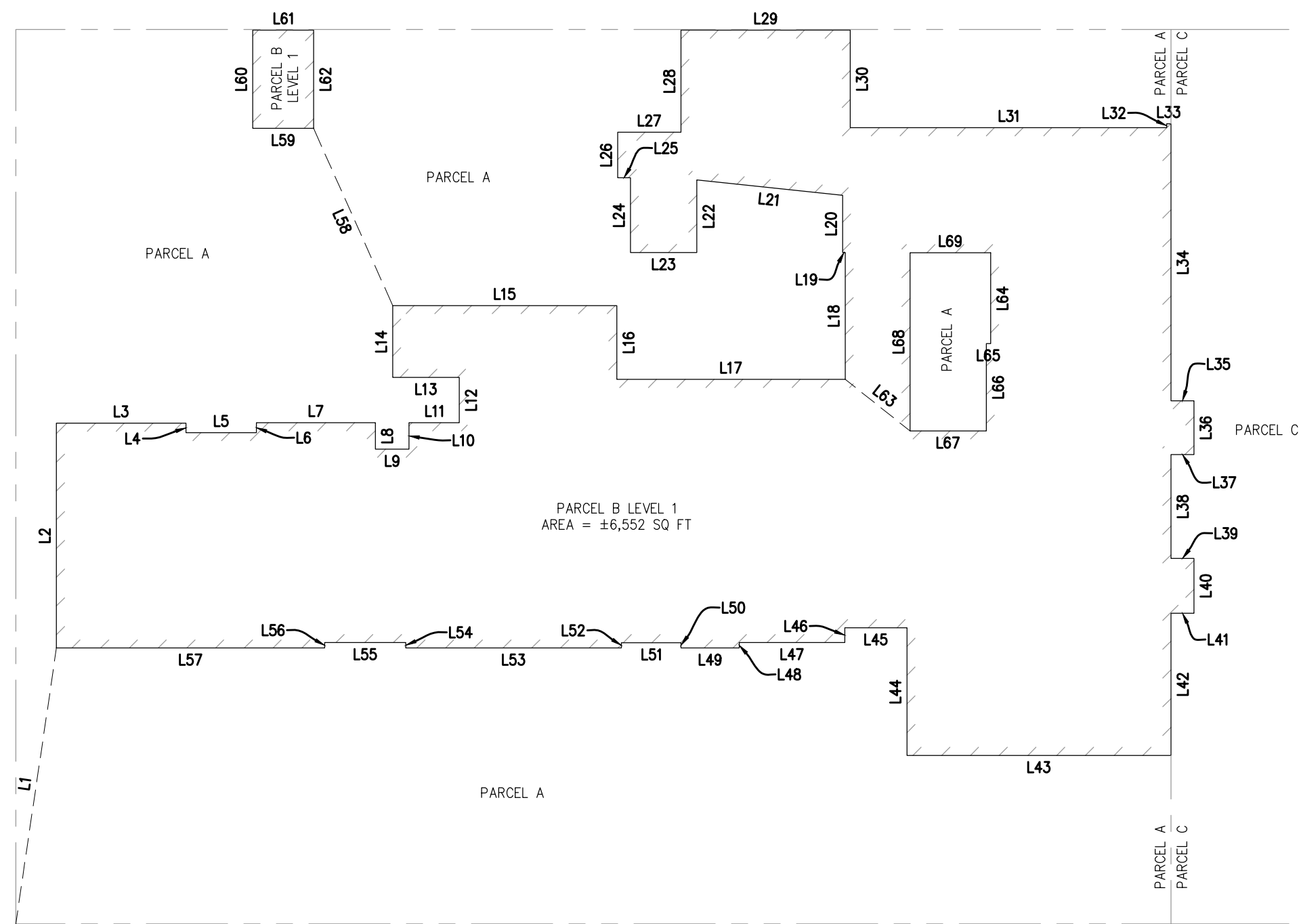

SHOWN ABOVE  
PARCEL B LEVEL 1  
SCALE: 1"=16'

Line	Length	Direction
L1	34.30	N00° 18' 42.98"E
L2	27.65	N08° 05' 20.00"W
L3	15.93	N81° 54' 40.00"E
L4	1.17	S08° 05' 20.00"E
L5	8.68	N81° 54' 40.00"E
L6	1.22	N08° 05' 20.00"W
L7	14.62	N81° 54' 40.00"E
L8	3.26	S08° 05' 20.00"E
L9	4.13	N81° 54' 40.00"E
L10	3.26	N08° 05' 20.00"W
L11	6.18	N81° 54' 40.00"E
L12	5.59	N08° 05' 20.00"W
L13	8.18	S81° 54' 40.00"W
L14	8.82	N08° 05' 20.00"W
L15	27.58	N81° 54' 40.00"E
L16	9.08	S08° 05' 20.00"E
L17	28.09	N81° 54' 40.00"E
L18	15.62	N08° 05' 20.00"W
L19	0.33	S81° 54' 40.00"W
L20	7.03	N08° 05' 20.00"W

Line	Length	Direction
L21	18.02	S87° 54' 40.00"W
L22	8.93	S08° 05' 20.00"E
L23	8.18	S81° 54' 40.00"W
L24	9.20	N08° 05' 20.00"W
L25	1.55	S81° 54' 40.00"W
L26	5.59	N08° 05' 20.00"W
L27	7.77	N81° 54' 40.00"E
L28	12.55	N08° 05' 20.00"W
L29	20.83	N81° 54' 40.00"E
L30	12.00	S08° 05' 21.43"E
L31	38.93	N81° 54' 40.00"E
L32	0.50	N08° 05' 20.00"W
L33	0.52	N81° 54' 40.00"E
L34	34.08	S08° 05' 20.00"E
L35	2.83	N81° 54' 40.00"E
L36	6.62	S08° 05' 20.00"E
L37	2.83	S81° 54' 40.00"W
L38	12.76	S08° 05' 20.00"E
L39	2.83	N81° 54' 40.00"E
L40	6.75	S08° 05' 20.00"E

Line	Length	Direction
L41	2.83	S81° 54' 40.00"W
L42	17.48	S08° 05' 20.00"E
L43	32.47	S81° 54' 40.00"W
L44	15.71	N08° 05' 20.00"W
L45	7.65	S81° 54' 40.00"W
L46	1.83	S08° 05' 20.00"E
L47	12.99	S81° 54' 40.00"W
L48	0.67	S08° 05' 20.00"E
L49	7.17	S81° 54' 40.00"W
L50	0.65	N08° 05' 20.00"W
L51	7.33	S81° 54' 40.00"W
L52	0.65	S08° 05' 20.00"E
L53	26.52	S81° 54' 40.00"W
L54	0.67	N08° 05' 20.00"W
L55	9.97	S81° 54' 40.00"W
L56	0.67	S08° 05' 20.00"E
L57	33.01	S81° 54' 40.00"W
L58	23.87	N32° 08' 40.92"W
L59	7.49	S81° 54' 40.00"W
L60	12.07	N08° 05' 20.00"W

Line	Length	Direction
L61	7.49	N81° 54' 40.00"E
L62	12.07	S08° 05' 20.00"E
L63	10.18	S59° 36' 30.50"E
L64	11.16	S08° 05' 20.00"E
L65	0.53	S81° 54' 40.00"W
L66	10.75	S08° 04' 54.42"E
L67	9.38	S81° 54' 40.00"W
L68	21.91	N08° 05' 20.00"W
L69	9.92	N81° 54' 40.00"E

LEGEND

- BUILDING INTERIOR PARCEL LINE
- ADJACENT PARCEL LINE
- PARCEL TIE LINE
- LOT LINE

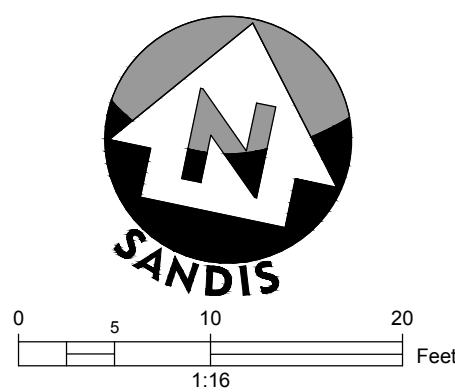

# PARCEL MAP NO. 11051

CONSISTING OF THREE AIR RIGHTS PARCELS  
BEING A RESUBDIVISION OF PORTIONS OF LOTS 46-54 OF  
"MAP OF COLLEGE TRACT", FILED ON JANUARY 31, 1880, IN MAP BOOK 9, PAGE 46  
ALAMEDA COUNTY RECORDS AND THE WESTERN 1 FOOT OF LOT 55.

CITY OF BERKELEY COUNTY OF ALAMEDA

SEPTEMBER, 2019

CONSISTING OF 11 SHEETS

**SANDIS** CIVIL ENGINEERS SURVEYORS PLANNERS  
1700 Winchester Boulevard, Campbell, CA 95008 | P. 408.636.0900 | F. 408.636.0999 | www.sandis.net  
SILICON VALLEY TRI-VALLEY CENTRAL VALLEY SACRAMENTO EAST BAY/SF

SHOWN BELOW  
ELEVATION VIEW OF PARCEL B  
NO SCALE

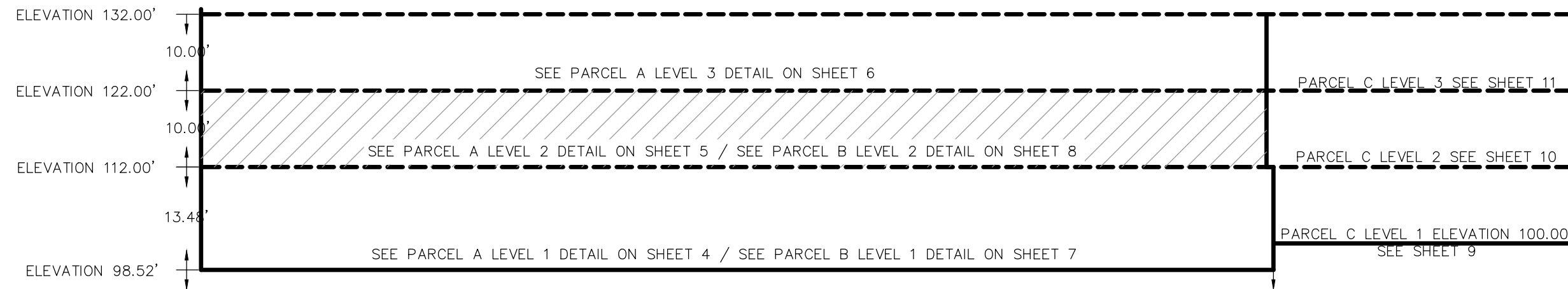

NOTE: ELEVATIONS BASED ON ARCHITECTURAL ELEVATIONS. 100.00' = 0'-0".  
NOTE: TO CENTER OF THE EARTH IS BELOW ELEVATIONS 100.00'

TO CENTER OF THE EARTH

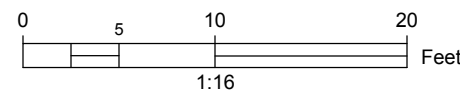
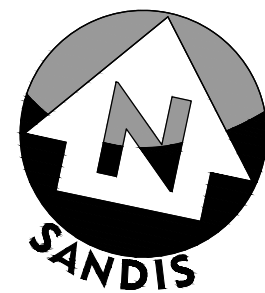

SHOWN BELOW  
PARCEL B LEVEL 2  
SCALE: 1"=16'

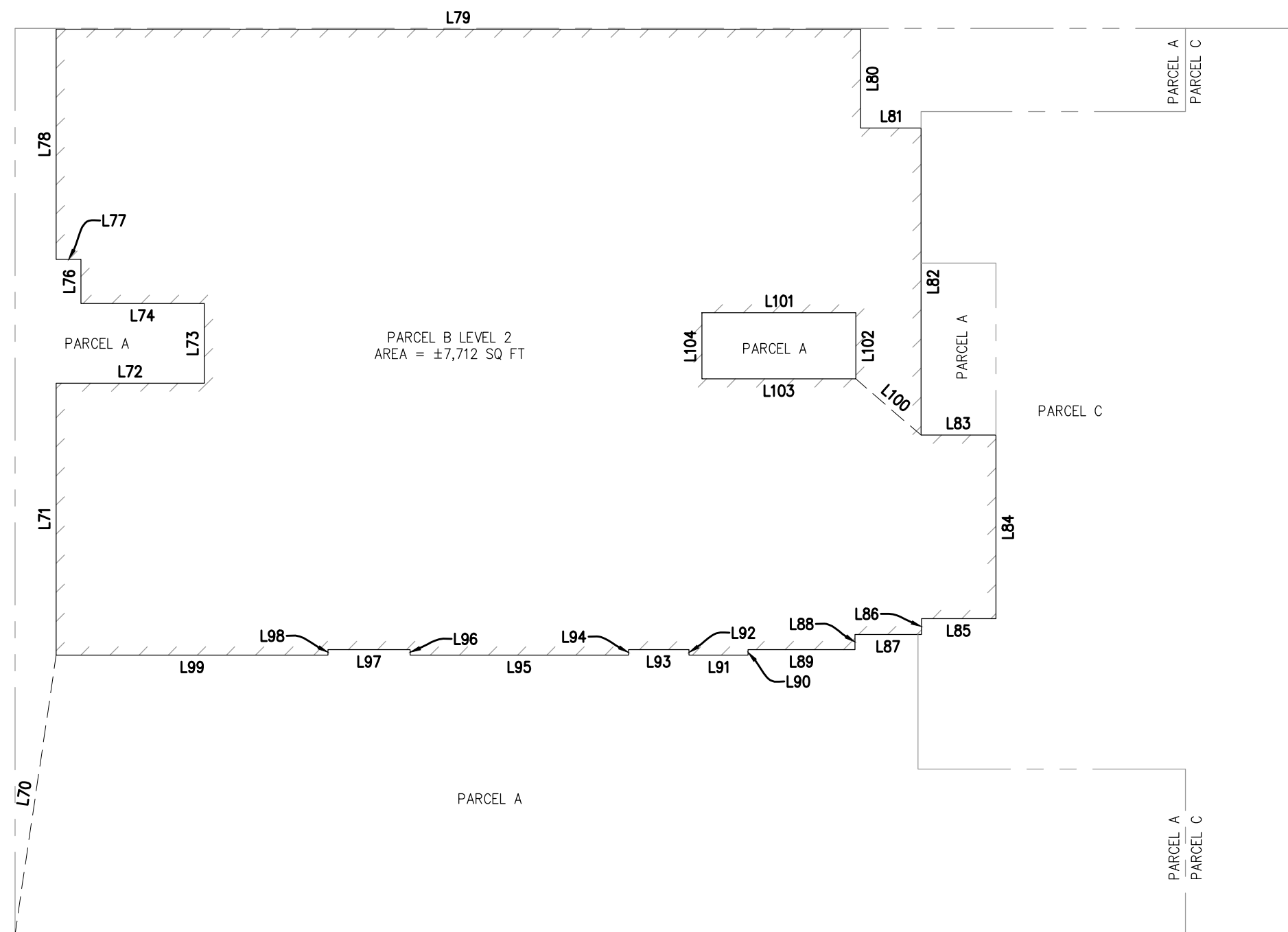

Line	Length	Direction
L70	34.30	N00° 18' 42.98"E
L71	33.01	N08° 05' 20.00"W
L72	17.99	N81° 54' 46.67"E
L73	9.68	N08° 05' 19.13"W
L74	14.99	S81° 54' 40.00"W
L76	5.35	N08° 05' 20.00"W
L77	3.00	S81° 54' 40.00"W
L78	27.94	N08° 05' 20.00"W
L79	97.65	N81° 54' 40.00"E
L80	12.00	S08° 05' 21.43"E
L81	7.35	N81° 54' 40.00"E
L82	37.28	S08° 05' 20.00"E
L83	9.08	N81° 54' 40.00"E
L84	22.27	S08° 05' 20.00"E
L85	9.02	S81° 54' 40.00"W
L86	1.93	S08° 05' 20.00"E
L87	8.08	S81° 54' 40.00"W
L88	1.83	S08° 05' 20.00"E
L89	12.99	S81° 54' 40.00"W
L90	0.67	S08° 05' 20.00"E

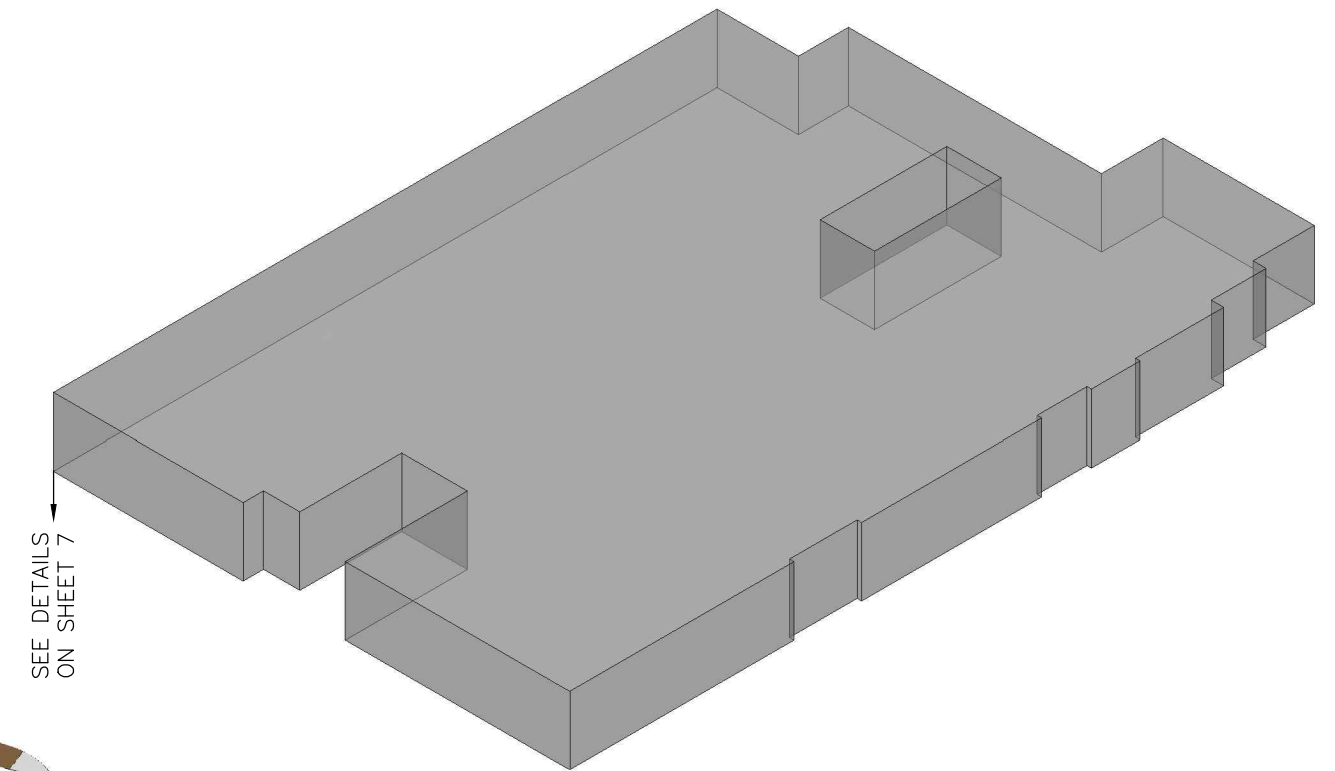

SEE DETAILS ON SHEET 7



SHOWN ABOVE  
ISOMETRIC VIEW OF PARCEL B LEVEL 2  
SCALE: 1"=20'

Line	Length	Direction
L91	7.17	S81° 54' 40.00"W
L92	0.65	N08° 05' 20.00"W
L93	7.33	S81° 54' 40.00"W
L94	0.65	S08° 05' 20.00"E
L95	26.52	S81° 54' 40.00"W
L96	0.67	N08° 05' 20.00"W
L97	9.97	S81° 54' 40.00"W
L98	0.67	S08° 05' 20.00"E
L99	33.01	S81° 54' 40.00"W
L100	10.47	S57° 19' 23.65"E
L101	18.67	N81° 54' 40.00"E
L102	8.02	S08° 05' 20.00"E
L103	18.67	S81° 54' 40.00"W
L104	8.02	N08° 05' 20.00"W

**LEGEND**

- BUILDING INTERIOR PARCEL LINE
- ADJACENT PARCEL LINE
- PARCEL TIE LINE
- LOT LINE

# PARCEL MAP NO. 11051

CONSISTING OF THREE AIR RIGHTS PARCELS  
BEING A RESUBDIVISION OF PORTIONS OF LOTS 46-54 OF  
"MAP OF COLLEGE TRACT", FILED ON JANUARY 31, 1880, IN MAP BOOK 9, PAGE 46  
ALAMEDA COUNTY RECORDS AND THE WESTERN 1 FOOT OF LOT 55.

CITY OF BERKELEY COUNTY OF ALAMEDA

SEPTEMBER, 2019

CONSISTING OF 11 SHEETS

**SANDIS** CIVIL ENGINEERS SURVEYORS PLANNERS

SILICON VALLEY TRI-VALLEY CENTRAL VALLEY SACRAMENTO EAST BAY/SF

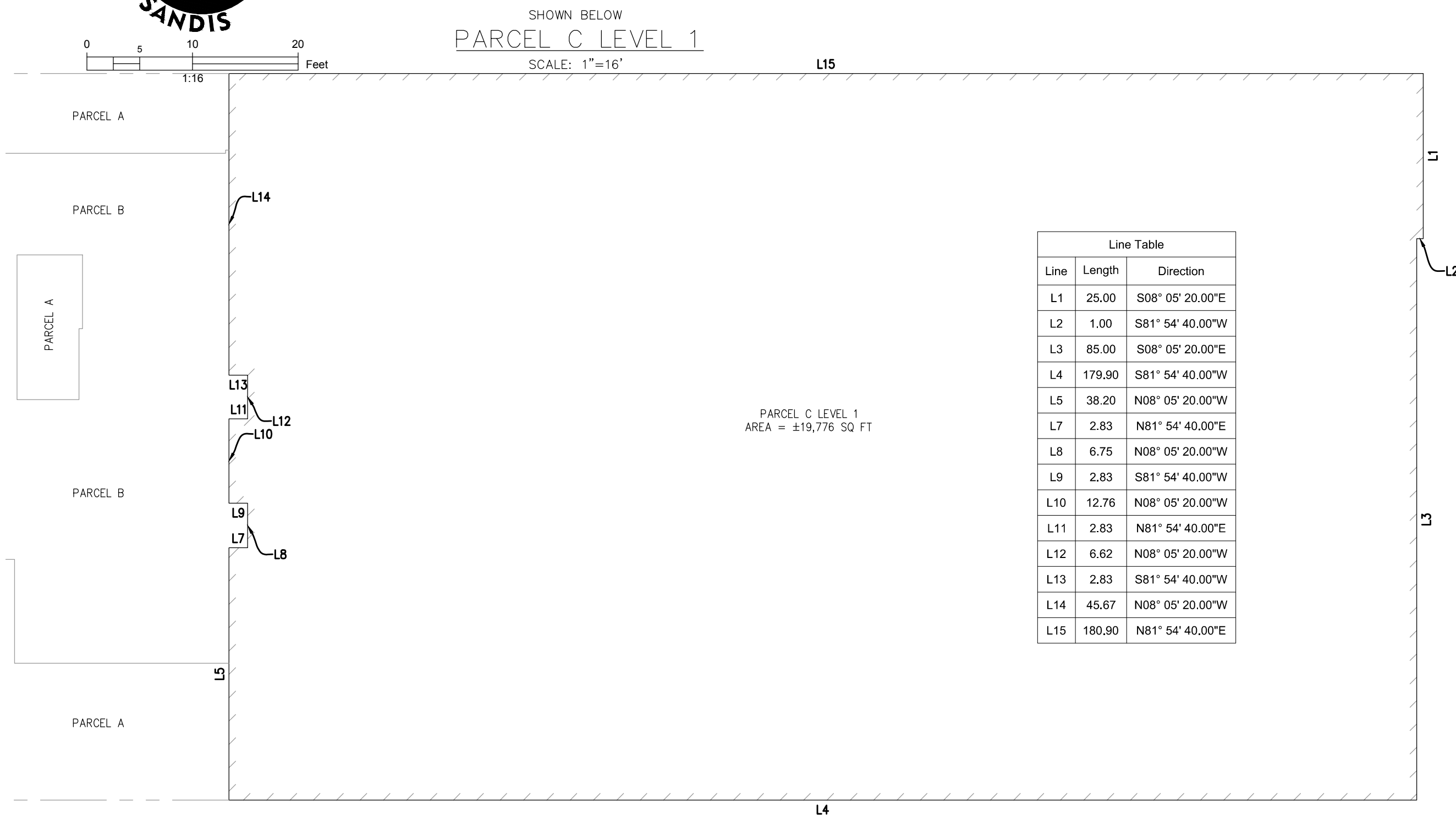
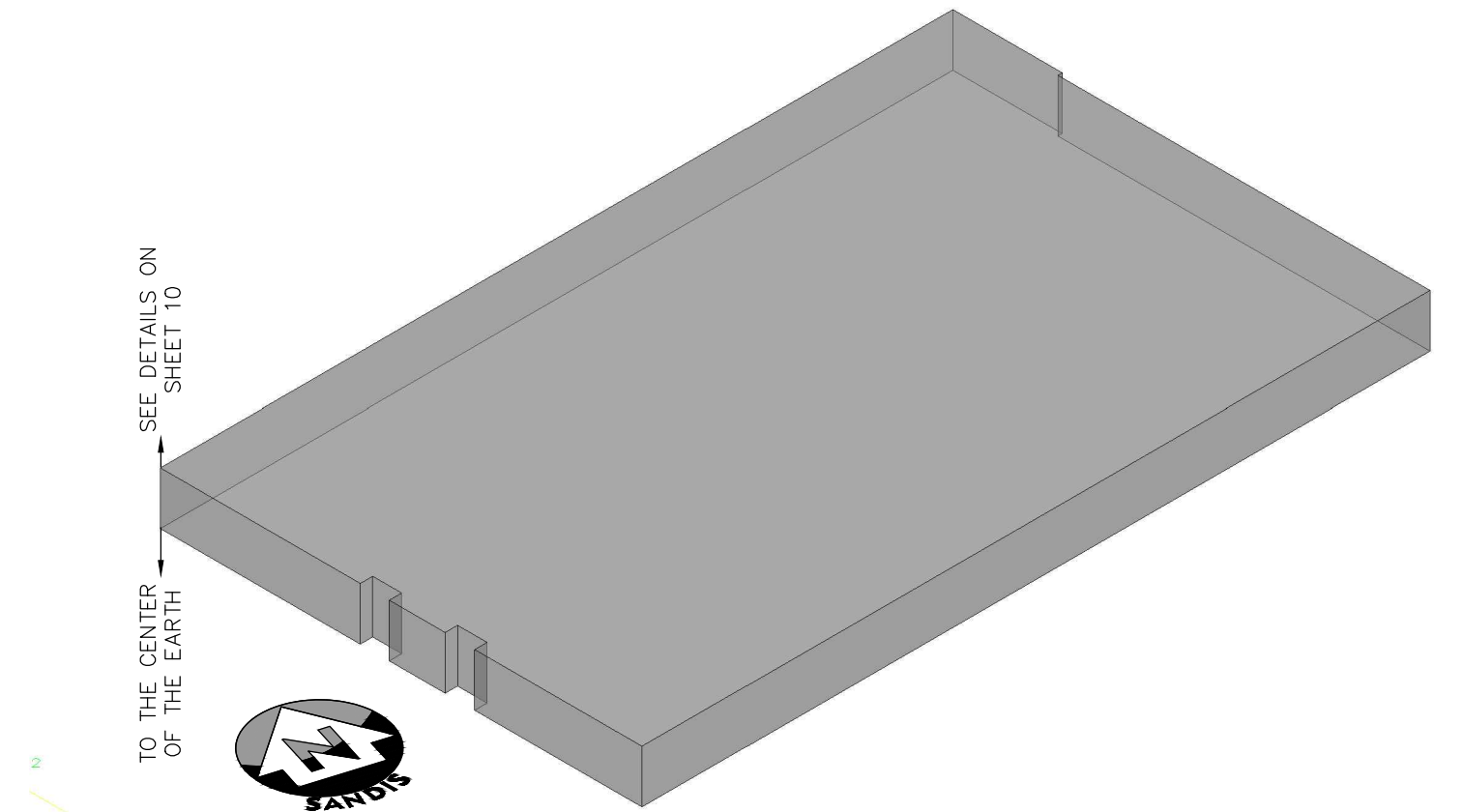
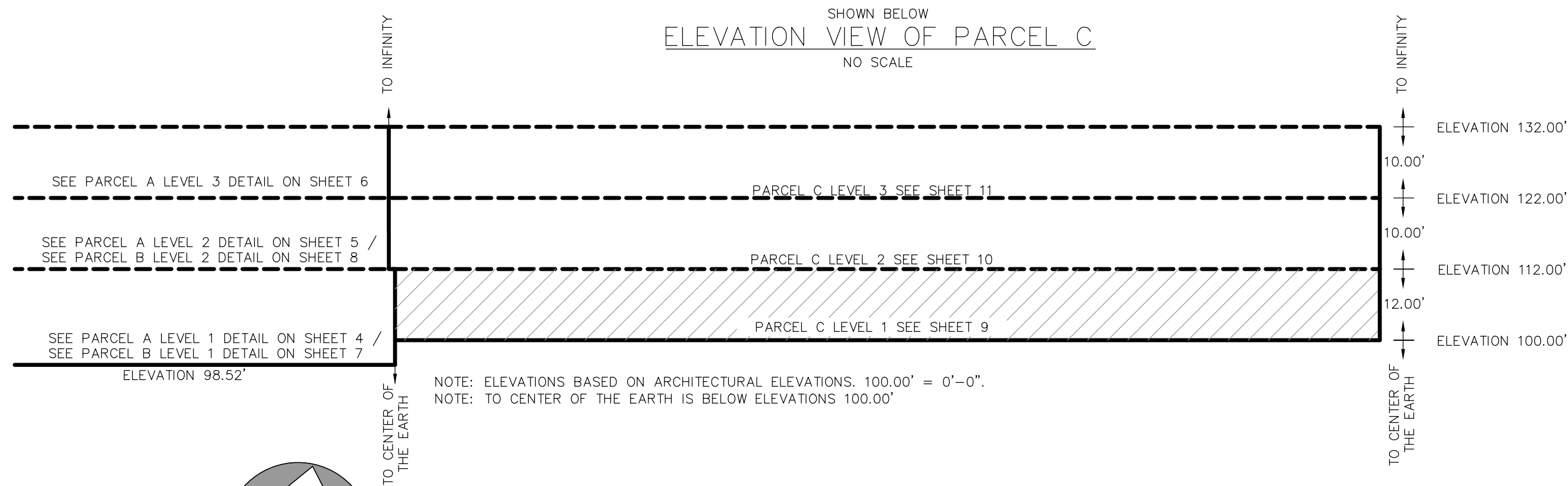

**LEGEND**

BUILDING INTERIOR PARCEL LINE	
ADJACENT PARCEL LINE	
PARCEL TIE LINE	
LOT LINE	

**PARCEL MAP NO. 11051**  
 CONSISTING OF THREE AIR RIGHTS PARCELS  
 BEING A RESUBDIVISION OF PORTIONS OF LOTS 46-54 OF  
 "MAP OF COLLEGE TRACT", FILED ON JANUARY 31, 1880, IN MAP BOOK 9, PAGE 46  
 ALAMEDA COUNTY RECORDS AND THE WESTERN 1 FOOT OF LOT 55.

CITY OF BERKELEY COUNTY OF ALAMEDA

SEPTEMBER, 2019

CONSISTING OF 11 SHEETS

**SANDIS** CIVIL ENGINEERS  
SURVEYORS  
PLANNERS

1700 Winchester Boulevard, Campbell, CA 95008 | P. 408.636.0900 | F. 408.636.0999 | www.sandis.net

SILICON VALLEY TRI-VALLEY CENTRAL VALLEY SACRAMENTO EAST BAY/SF



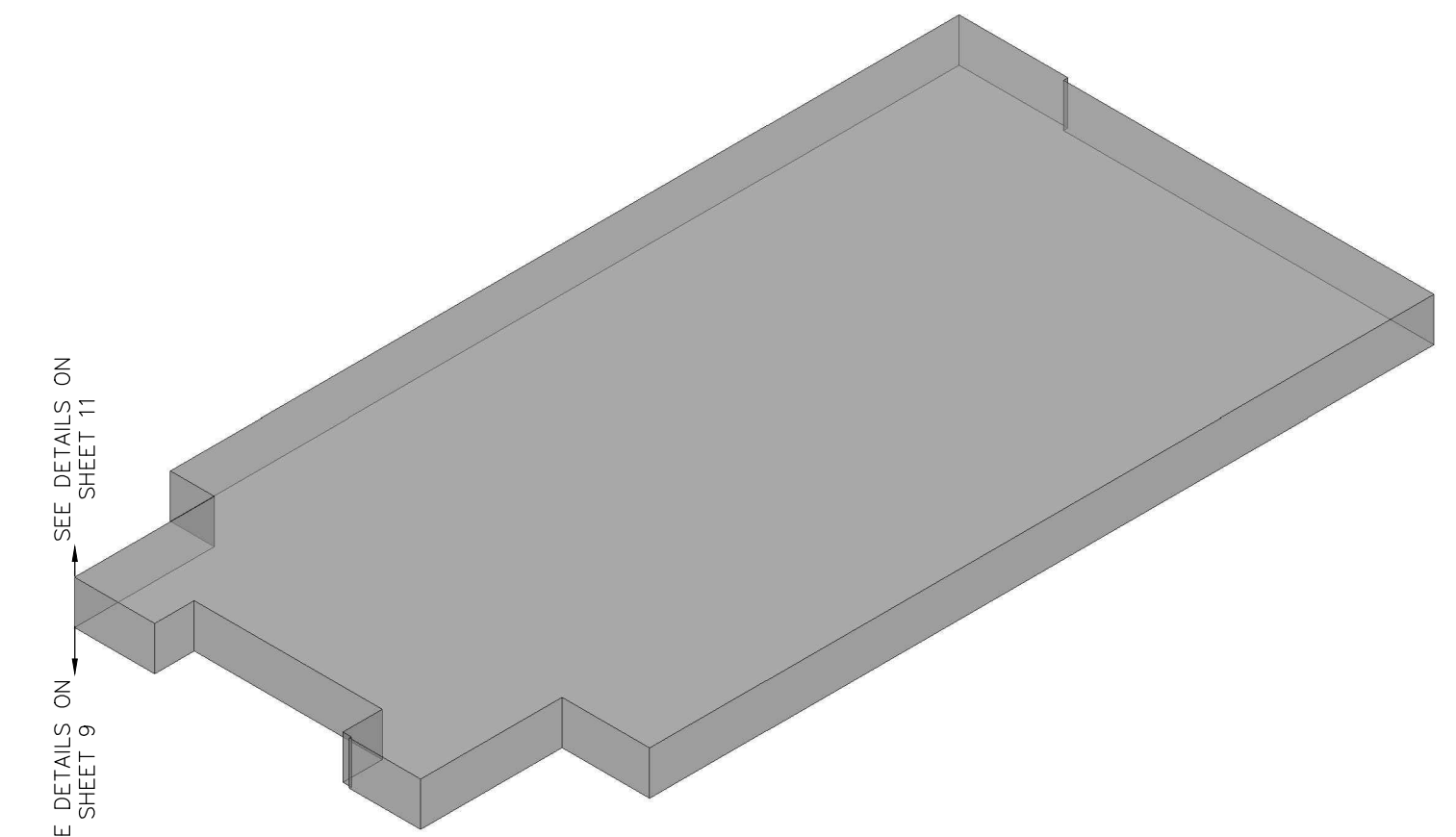
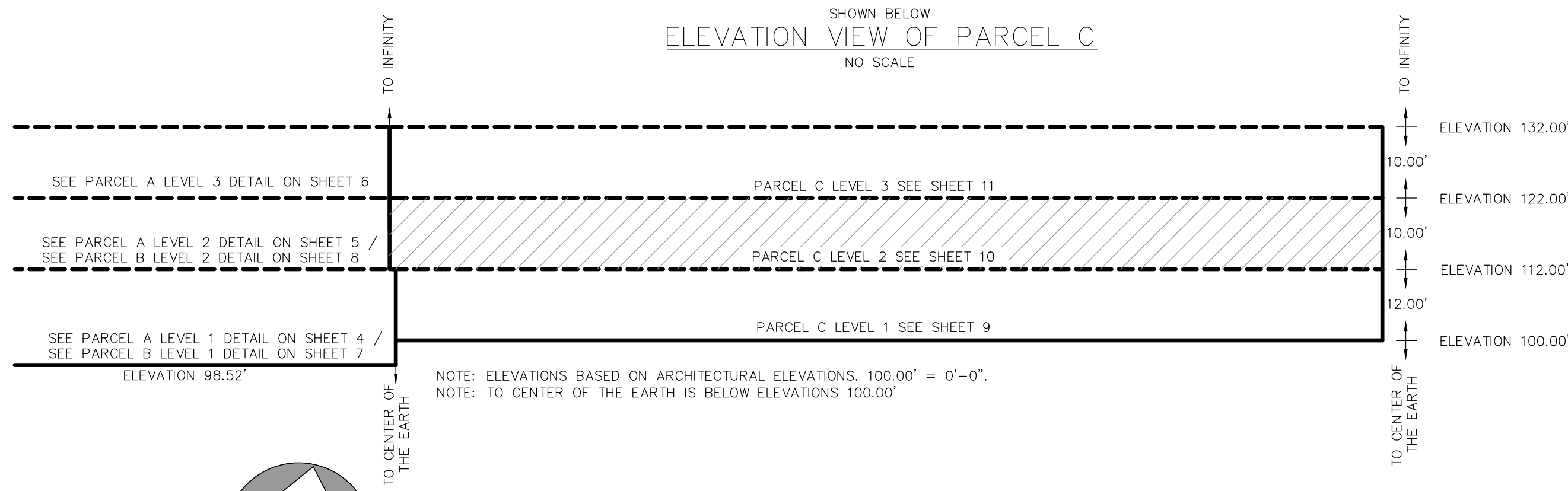

SHOWN ABOVE  
ISOMETRIC VIEW OF PARCEL C LEVEL 2  
SCALE: 1"=30'

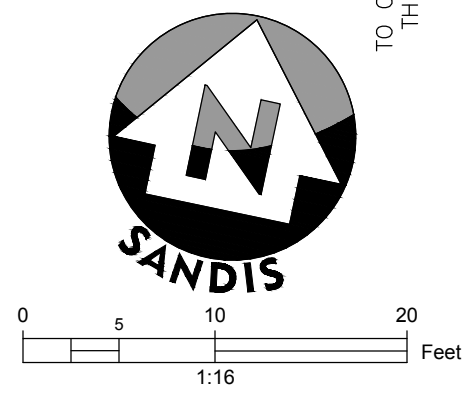

SHOWN BELOW  
PARCEL C LEVEL 2  
SCALE: 1"=16'

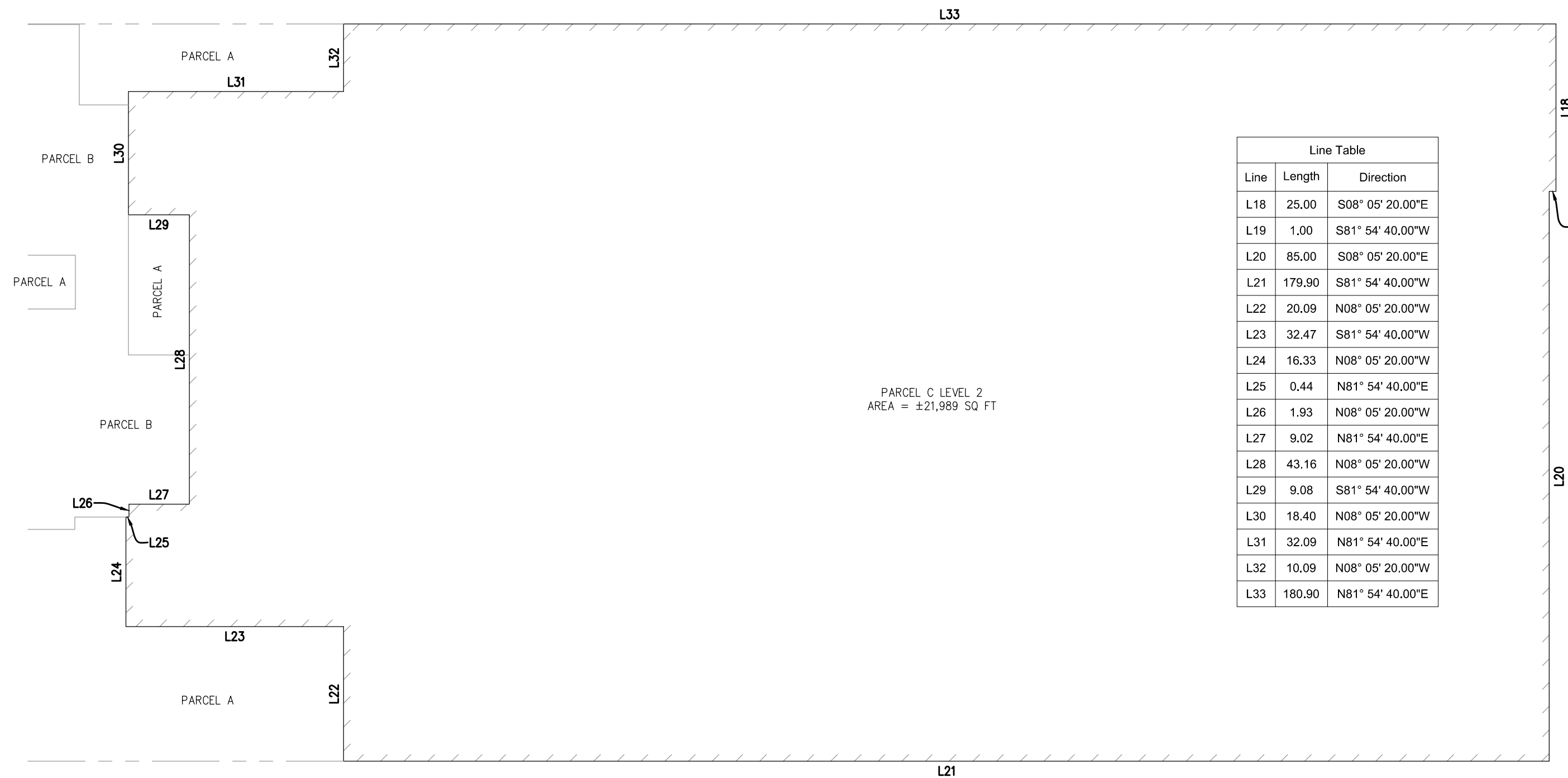

Line Table		
Line	Length	Direction
L18	25.00	S08° 05' 20.00"E
L19	1.00	S81° 54' 40.00"W
L20	85.00	S08° 05' 20.00"E
L21	179.90	S81° 54' 40.00"W
L22	20.09	N08° 05' 20.00"W
L23	32.47	S81° 54' 40.00"W
L24	16.33	N08° 05' 20.00"W
L25	0.44	N81° 54' 40.00"E
L26	1.93	N08° 05' 20.00"W
L27	9.02	N81° 54' 40.00"E
L28	43.16	N08° 05' 20.00"W
L29	9.08	S81° 54' 40.00"W
L30	18.40	N08° 05' 20.00"W
L31	32.09	N81° 54' 40.00"E
L32	10.09	N08° 05' 20.00"W
L33	180.90	N81° 54' 40.00"E

LEGEND

BUILDING INTERIOR PARCEL LINE	
ADJACENT PARCEL LINE	
PARCEL TIE LINE	
LOT LINE	

# PARCEL MAP NO. 11051

CONSISTING OF THREE AIR RIGHTS PARCELS  
BEING A RESUBDIVISION OF PORTIONS OF LOTS 46-54 OF  
"MAP OF COLLEGE TRACT", FILED ON JANUARY 31, 1880, IN MAP BOOK 9, PAGE 46  
ALAMEDA COUNTY RECORDS AND THE WESTERN 1 FOOT OF LOT 55.

CITY OF BERKELEY COUNTY OF ALAMEDA

SEPTEMBER, 2019

CONSISTING OF 11 SHEETS

**SANDIS** CIVIL ENGINEERS  
SURVEYORS  
PLANNERS

1700 Winchester Boulevard, Campbell, CA 95008 | P. 408.636.0900 | F. 408.636.0999 | www.sandis.net

SILICON VALLEY TRI-VALLEY CENTRAL VALLEY SACRAMENTO EAST BAY/SF

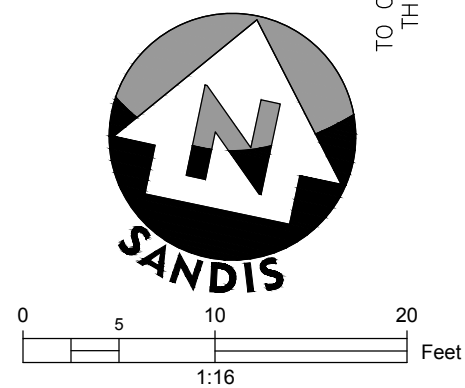
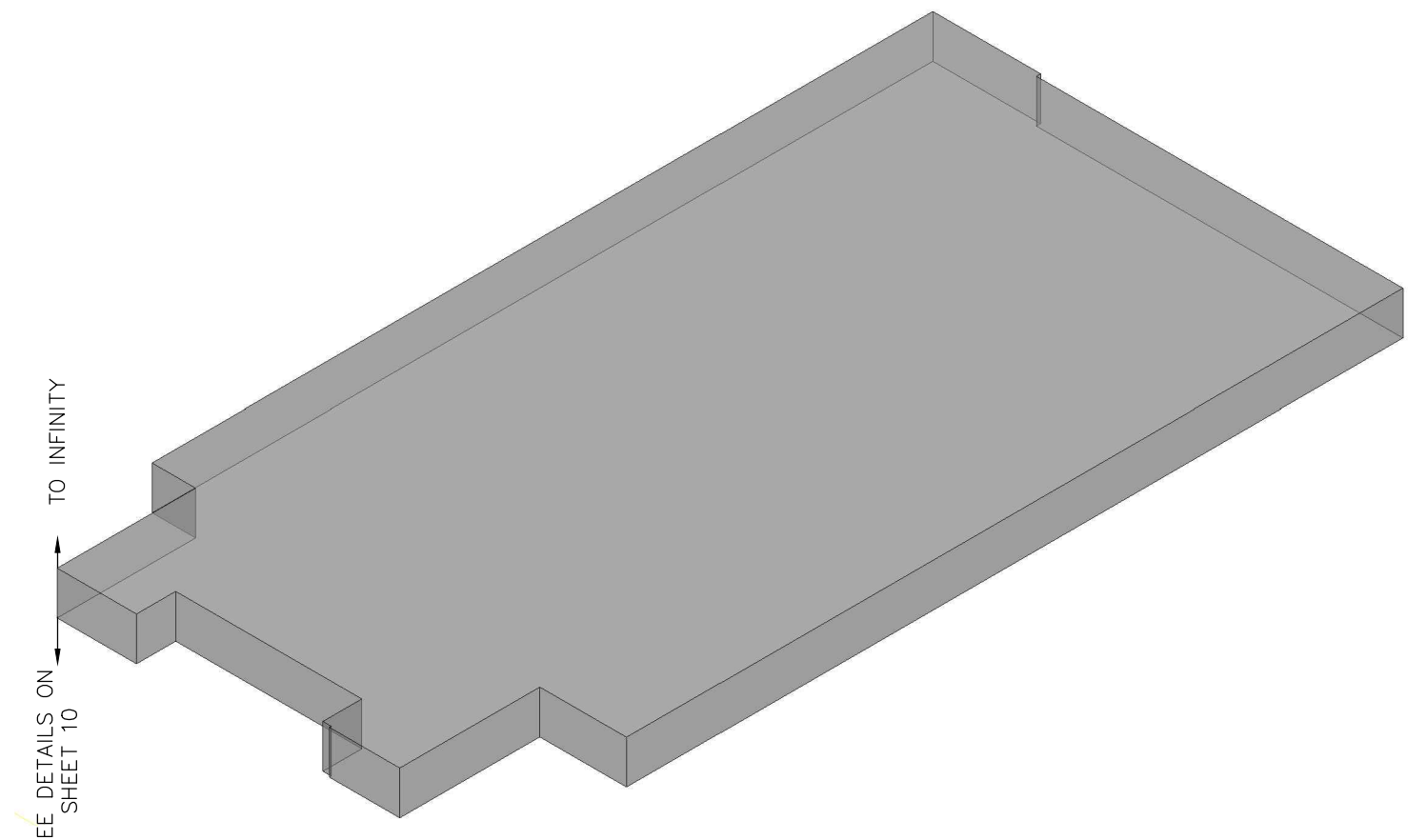
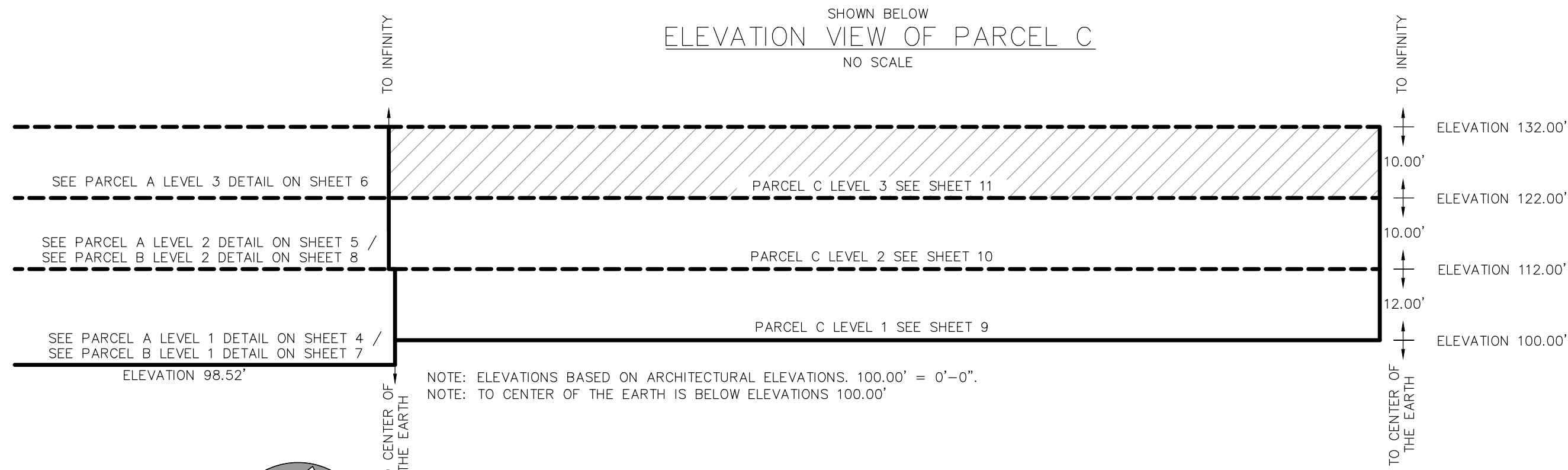

SHOWN BELOW  
PARCEL C LEVEL 3 AND UP  
SCALE: 1"=16'

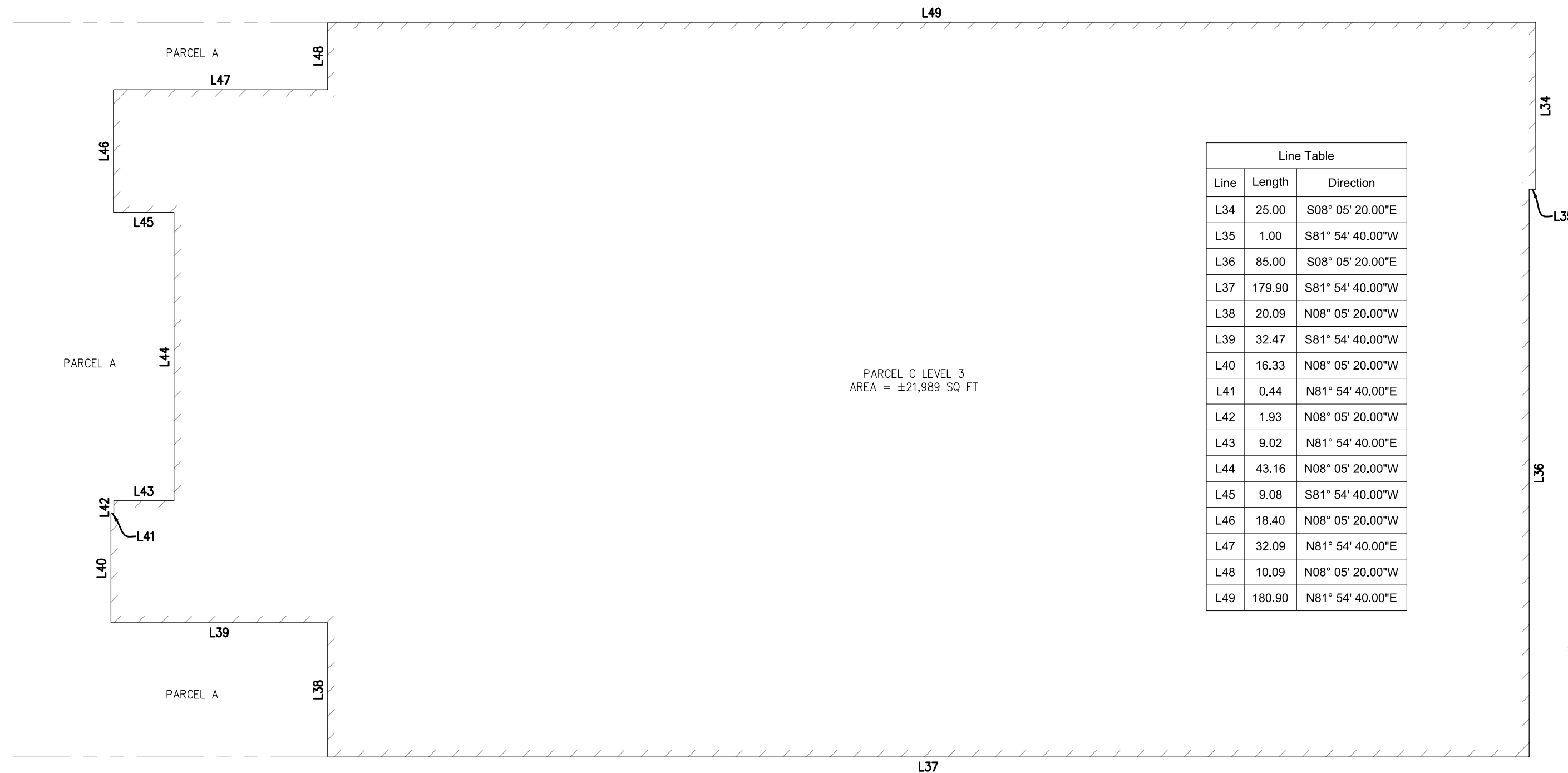

Line Table		
Line	Length	Direction
L34	25.00	S08° 05' 20.00"E
L35	1.00	S81° 54' 40.00"W
L36	85.00	S08° 05' 20.00"E
L37	179.90	S81° 54' 40.00"W
L38	20.09	N08° 05' 20.00"W
L39	32.47	S81° 54' 40.00"W
L40	16.33	N08° 05' 20.00"W
L41	0.44	N81° 54' 40.00"E
L42	1.93	N08° 05' 20.00"W
L43	9.02	N81° 54' 40.00"E
L44	43.16	N08° 05' 20.00"W
L45	9.08	S81° 54' 40.00"W
L46	18.40	N08° 05' 20.00"W
L47	32.09	N81° 54' 40.00"E
L48	10.09	N08° 05' 20.00"W
L49	180.90	N81° 54' 40.00"E

LEGEND

BUILDING INTERIOR PARCEL LINE	
ADJACENT PARCEL LINE	
PARCEL TIE LINE	
LOT LINE	

**PARCEL MAP NO. 11051**

CONSISTING OF THREE AIR RIGHTS PARCELS  
BEING A RESUBDIVISION OF PORTIONS OF LOTS 46-54 OF  
"MAP OF COLLEGE TRACT", FILED ON JANUARY 31, 1880, IN MAP BOOK 9, PAGE 46  
ALAMEDA COUNTY RECORDS AND THE WESTERN 1 FOOT OF LOT 55.

CITY OF BERKELEY COUNTY OF ALAMEDA

SEPTEMBER, 2019

CONSISTING OF 11 SHEETS

**SANDIS** CIVIL ENGINEERS  
SURVEYORS  
PLANNERS

1700 Winchester Boulevard, Campbell, CA 95008 | P. 408.636.0900 | F. 408.636.0999 | www.sandis.net

SILICON VALLEY TRI-VALLEY CENTRAL VALLEY SACRAMENTO EAST BAY/SF